

EFFECT OF ADDITIVE MORPHOLOGY & CHEMISTRY ON WEAR & FRICTION OF
GREASES UNDER SPECTRUM LOADING

by

SUJAY DILIP BAGI

Presented to the Faculty of the Graduate School of
The University of Texas at Arlington in Partial Fulfillment
of the Requirements
for the Degree of

MASTER OF SCIENCE IN MATERIALS SCIENCE AND ENGINEERING

THE UNIVERSITY OF TEXAS AT ARLINGTON

December 2012

Copyright © by Sujay Bagi 2012

All Rights Reserved

ACKNOWLEDGEMENTS

I would sincerely like to express the deepest appreciation and gratitude to my advisor and committee chair, Dr. Pranesh Aswath, who has continually encouraged me with the spirit of independent thinking and instilled a research acumen in me throughout my time as a graduate student in the Department of Materials Science & Engineering at the University of Texas at Arlington. His fabulous knowledge of subject matter and meticulous way of guidance makes him the most remarkable mentor in the department.

My sincere gratitude to the committee members, Dr. Yaowu Hao and Dr. Fuqiang Liu for being so encouraging and cordial; I am indebted to many of my colleagues and friends at UTA for making this time one of the most memorable moments in my life.

I would like to whole-heartedly thank Dr Xin Chen for all the help regarding the chemistry formulations and Soxhlet apparatus. I would like to express my deepest gratitude to Dr. Mihir Patel for being a great friend and a mentor; I would like to acknowledge all my colleagues in the Tribology & Bio-materials group Megan Velten, Olumide Oruwajoye, Pradip Sairam, Vibhu Sharma, Ami Shah, Olusanmi Adeniran for all the help and the support I received. My sincere words of appreciation for Eray Erkan and Jei He for all the help and support in using the characterization equipment's in CCMB; to Helen Hough, Libia Cuauhtli and Jennifer Standlee, for their help related to official matters, thesis writing and for all of their good wishes; My sincere acknowledgement to Dr. Jiechao Jiang and David Yen for the help and training with the CCMB characterization facility. I would also like to thank other grad students Dong Liu, Swathi Murthy, Amir Salehi, Manoucher Teimouri, Aida M Roshan, Zi Wei, Yishu Wang and Eric Yeh for their support.

My sincere words of appreciation go to my family members and friends for their compassion and backings in completing this project. I would like to acknowledge my parents Dr. Dilip Bagi and Dr. Shraddha Bagi for their continual affection, love and support without which I wouldn't have achieved all my dreams. I would like to thank my brother Sourabh Bagi for being an awesome person in my life with all his support & understanding. I would also like to acknowledge my family members Badal Bagi, Alhad Bagi, Preetam Bagi, Pradeep Bagi, Anil Manere, Yash Manere, Sheetal Manere, Sudhakar Manere, Gautam Killedar, Gomtesh Killedar for their unwavering support throughout my Master's program.

I would sincerely like to acknowledge Mr. Bharath Kamma who has been a source of inspiration and motivation to me throughout my career; all my friends and colleagues at John Deere, Albemarle Corporation and BMS College of Engineering.

I would like to whole-heartedly thank Harsha Doreswamy, Sudeep Gangavathi, Avinash Bharadwaj, Sumanth Meda Jayaprakash, Bharat Venugopal, Abhishek Bangalore and Pavan Kanajar my friends and roommates at UTA, and I wish them all the very best & a marvelous life.

December 4, 2012

ABSTRACT

EFFECT OF SPECTRUM LOADING ON PERFORMANCE OF GREASES

Sujay Bagi, M.S.

The University of Texas at Arlington, 2012

Supervising Professor: Pranesh Aswath

The primary focus of grease development is to minimize friction and improve on wear and load bearing capacity. Traditional method to evaluate wear behavior of grease is based on ASTM D2266 which evaluates the performance of grease at 75°C, 40Kg and 1200 rpm for 1 hour. However, actual applications may require bearings to be subjected to spectrum loading conditions where-in rotations per minute (rpm), load and duration of test are variables. A series of six tests were conducted for all the grease blends; load was treated as the variable in four of the tests while maintaining the frequency constant and in the other two tests frequency was treated as the variable while keeping the load constant. Four different blends of greases were formulated using techfine or unmilled MoS₂, milled MoS₂, the third one consisting of a combination of PTFE & ZDDP and the fourth one consisting of a combination of PTFE, ZDDP and MoDTC, which were then tested under spectrum loading conditions where loads, frequency and duration of the tests were treated as variables. MoS₂ has long been considered as an Extreme Pressure (EP) additive; however untreated MoS₂ at lower loads behaves as pro-abrasive agent leading to an increase in the wear numbers. Milled MoS₂ was primarily used to study the deteriorating role played by the sharp edges or corners of the MoS₂. The third blend

which used a combination of PTFE (Polytetrafluoroethylene) & ZDDP (Zinc Dialkyldithiophosphate) was used as PTFE acts as a friction modifier and ZDDP as an anti-wear additive. The fourth blend which consisted of PTFE, ZDDP & MoDTC (Molybdenum Dithiocarbamate) was tested to study the effect of friction modifier on the combination of PTFE & ZDDP. With intent to replace the MoS₂ based greases the combination of PTFE, ZDDP and the combination of PTFE, ZDDP & MoDTC were proven to be synergistic and reported very low wear and friction numbers. Four ball tribometer was used to carry out the wear tests. E52100 steel balls as specified by the ASTM D2266 standard were used. The role played by the test variables on wear and friction was examined; the tribofilm formed on the surface was analyzed using various characterization techniques like SEM, EDS and Stereo Optical Microscopy. This research is focused on understanding the interactions of various additive chemistries and milling conditions under the influence of load, temperature and rpm.

Ball milling of MoS₂ leads to significant changes in the morphology of the particles owing to which a significant improvement in the wear behavior and friction coefficient is seen. Functionalization of PTFE particles with electron beam irradiation makes the PTFE particles highly polar and increases the surface affinity of the particles leading to a better tribofilm resulting in significantly reduced wear. The addition of a friction modifier like MoDTC to a mixture of PTFE and ZDDP further reduces friction and wear due to its synergistic interaction with the additives.

TABLE OF CONTENTS

ACKNOWLEDGEMENTS	iii
ABSTRACT	v
LIST OF ILLUSTRATIONS.....	xi
LIST OF TABLES	xiv
Chapter	Page
1. GENERAL OVERVIEW.....	1
1.1 Objectives and Drive for the Research work.....	3
1.2 Outline of the Research work.....	5
2. BACKGROUND.....	6
2.1 Tribology.....	6
2.1.1 History of Tribology	6
2.1.2 Interdisciplinary aspects.....	7
2.2 Friction.....	9
2.2.1 Laws of Friction	10
2.2.2 Asperities and Stick-slip phenomenon.....	12
2.2.3 Adhesion theory of friction.....	14
2.3 Wear.....	15
2.3.1 Mechanisms of Wear	16
2.3.1.1 Adhesive wear.....	16
2.3.1.2 Abrasive wear	17
2.3.1.3 Corrosive wear	17
2.3.1.4 Fatigue	18
2.3.2 Stages of Wear	20
2.4 Lubrication.....	21

2.4.1 Lubrication regimes.....	23
2.4.2 Stribeck curve	26
2.5 Greases.....	28
2.5.1 Grease composition and properties	29
2.5.2 Grease thickeners	32
2.5.3 Additives.....	34
2.6 MoS ₂ structure and properties	37
2.6.1 Mechanism of friction of MoS ₂	38
2.6.2 Effect of various parameters on MoS ₂ when used as a lubricant.....	41
2.7 ZDDP, PTFE & MoDTC	43
2.7.1 ZDDP.....	43
2.7.2 PTFE	47
2.7.3 MoDTC	49
2.8 Tribofilm.....	51
3. EXPERIMENTAL APPROACH AND MATERIALS USED	57
3.1 Additive chemistries and Formulation of greases	57
3.1.1 Base grease	57
3.1.2 Additive chemistries & blending of greases	58
3.2 Experimental setup	63
3.2.1 Four Ball Tribometer	64
3.2.2 SEM and EDS	66
3.2.3 SOM (Stereo Optical Microscopy)	67
3.2.4 Sputtering.....	67
3.3 Test conditions matrix	68
4. EFFECT OF MoS ₂ MORPHOLOGY ON WEAR & FRICTION COEFFICIENT UNDER SPECTRUM LOADING CONDITIONS	71
4.1 Introduction.....	71
4.2 Experimental procedure	73

4.2.1 Additive Chemistries and Formulation of Greases	73
4.2.2 Four-ball Tribometer tests	75
4.2.3 Scanning Electron Microscopy (SEM) and Stereo-Optical Microscopy studies	76
4.3 Results	76
4.3.1 SEM analysis of the MoS ₂ particles	77
4.3.2 Analysis of the Wear Scar Diameter (WSD)	78
4.3.3 Torque and Coefficient of Friction (COF)	79
4.3.4 SEM analysis of the Wear surface	82
4.4 Discussions	87
4.4.1 Effect of particle morphology	87
4.4.2 Effect of cyclic loading conditions	88
4.4.3 Effect of cyclic frequency conditions	92
4.5 Conclusions	94
5. COMPARISON OF FRICTION AND WEAR PERFORMANCE OF MoS ₂ & NON-MoS ₂ GREASES UNDER SPECTRUM LOADING CONDITIONS	96
5.1 Introduction	96
5.2 Experimental procedure	99
5.2.1 Additive Chemistries and Formulation of Greases	99
5.2.2 Four-ball Tribometer tests	100
5.2.3 Scanning Electron Microscopy (SEM) and Stereo-Optical Microscopy studies	101
5.3 Results	102
5.3.1 SEM analysis of PTFE & MoS ₂ particles	102
5.3.2 Analysis of the Wear Scar Diameter (WSD)	104
5.3.3 Torque and Coefficient of Friction (COF)	105
5.3.4 SEM analysis of the Wear surface	109
5.4 Discussions	113
5.4.1 Effect of particle morphology	114

5.4.2 Effect of cyclic loading conditions	115
5.4.3 Effect of cyclic frequency conditions	119
5.4.4 Synergism in between ZDDP and PTFE.....	122
5.5 Conclusions.....	123
6. ROLE OF FRICTION MODIFIERS ON FRICTION AND WEAR PERFORMANCE OF GREASES UNDER SPECTRUM LOADING CONDITIONS.....	125
6.1 Introduction.....	125
6.2 Experimental procedure	128
6.2.1 Additive Chemistries and Formulation of Greases	128
6.2.2 Four-ball Tribometer tests.....	129
6.2.3 Scanning Electron Microscopy (SEM) and Stereo-Optical Microscopy studies.....	131
6.3 Results	132
6.3.1 Analysis of the Wear Scar Diameter (WSD)	132
6.3.2 Torque and Coefficient of Friction (COF).....	132
6.3.3 SEM analysis of the Wear surface.....	137
6.4 Discussions	141
6.4.1 Effect of cyclic loading conditions	142
6.4.2 Effect of cyclic frequency conditions	143
6.4.3 Synergism in between additive chemistries	147
6.5 Conclusions.....	149
7. CONCLUSIONS	151
8. SUGGESTED FUTURE WORK.....	154
APPENDIX	
A. PROTOCOL FOR GREASE PREPARATION	155
B. PROTOCOL FOR RUNNING FOUR BALL WEAR TESTS AND CLEANING METHODOLOGIES	158
REFERENCES.....	161
BIOGRAPHICAL INFORMATION	175

LIST OF ILLUSTRATIONS

Figure		Page
2.1	Graphic description of interaction of tribology with other sciences	8
2.2	A pictographic representation of Tribological system	9
2.3	Representation of frictional forces in play	11
2.4	A pictographic representation of asperities.....	13
2.5	A classic illustration of Stick-slip system.....	14
2.6	Foreign materials adhered to the metal substrate	15
2.7	A representation of Adhesive wear mechanism	17
2.8	An illustration of (a) Two body abrasive wear (b) Three body abrasive wear	18
2.9	A schematic representation of corrosive wear mechanism	19
2.10	Illustration of contact fatigue	19
2.11	Different stages in wear of a machine component.....	21
2.12	Representation of different regimes of lubrication	24
2.13	Stribeck curve showing different lubrication regimes.....	26
2.14	Stribeck curve showing the relation in between friction coefficient and separation in between the layers.....	27
2.15	Grease composition	29
2.16	Chemical reaction for preparation of grease thickener	32
2.17	Crystal structure of MoS ₂ particles.....	39
2.18	Original route used to manufacture ZDDP.....	44
2.19	Neutral ZDDP molecule	44
2.20	Picture showing the polymerization of TFE monomer to form PTFE.....	47
2.21	Multiple layers of FM molecules on the metal substrate.....	50
2.22	A structural drawing of Molybdenum Dithiocarbamate	50
2.23	Tribofilm formed from different additive chemistries	54

2.24	Simplified view of Boundary lubrication	55
2.25	Patchy tribofilm formed from Ashless thiophosphates.....	56
3.1	Kitchen aid mixer used for blending of greases in the TLCL lab at UTA.....	60
3.2	Commercial ball-mill used for the milling process.....	61
3.3	Schematic representation of the four ball geometry	64
3.4	The Four Ball Tribometer at TLCL facility in UTA	65
3.5	SEM located in the CCMB facility at UTA	66
3.6	Stereo Optical Microscope located in the CCMB facility at UTA	67
3.7	Sputtering machine located in the CCMB facility at UTA	68
4.1	SEM images of (a) Unmilled MoS ₂ at 500X (b) Unmilled MoS ₂ at 1000X (c) Milled MoS ₂ at 500X (d) Milled MoS ₂ at 1000X.....	77
4.2	Wear Scar Diameters for Blend 1 and Blend 2.....	78
4.3	(a, c) Torque (Nm) and (b, d) COF values for cyclic loading conditions with a load step size of 15 minutes	79
4.4	(a, c) Torque (Nm) and (b, d) COF values for cyclic loading conditions with a load step size of 7.5 minutes	80
4.5	(a, c) Torque (Nm) and (b, d) COF values for cyclic frequency conditions with a frequency step size of 600 rpm	82
4.6	Low magnification SEM images for Unmilled MoS ₂ grease wherein (a to f) represent the images from Test 1 to Test 6.....	83
4.7	High magnification SEM images for Unmilled MoS ₂ grease wherein (a to f) represent the images from Test 1 to Test 6.....	84
4.8	Low magnification SEM images for Milled MoS ₂ grease wherein (a to f) represent the images from Test 1 to Test 6.....	85
4.9	High magnification SEM images for Milled MoS ₂ grease wherein (a to f) represent the images from Test 1 to Test 6.....	86
5.1	(a, b) SEM images of MoS ₂ particles at 500X and 1000X (c, d) SEM images of PTFE particles at 50X and 100X	103
5.2	Wear Scar Diameters for Blend 1 and Blend 2.....	104
5.3	(a, c) Torque (Nm) and (b, d) COF values for cyclic loading conditions with a load step size of 15 minutes	106
5.4	(a, c) Torque (Nm) and (b, d) COF values for cyclic loading conditions with a load step size of 7.5 minutes	107

5.5	(a, c) Torque (Nm) and (b, d) COF values for cyclic frequency conditions with a frequency step size of 600 rpm	108
5.6	Low magnification SEM images for Blend 1 grease containing MoS ₂ particles wherein (a to f) represent the images from Test 1 to Test 6	109
5.7	High magnification SEM images for Blend 1 grease containing MoS ₂ particles wherein (a to f) represent the images from Test 1 to Test 6	110
5.8	Low magnification SEM images for Blend 2 grease containing ZDDP & PTFE wherein (a to f) represent the images from Test 1 to Test 6	111
5.9	High magnification SEM images for Blend 2 grease containing ZDDP & PTFE wherein (a to f) represent the images from Test 1 to Test 6	112
6.1	Wear Scar Diameters for Blend 1 and Blend 2	133
6.2	(a, c) Torque (Nm) and (b, d) COF values for cyclic loading conditions with a load step size of 15 minutes	134
6.3	(a, c) Torque (Nm) and (b, d) COF values for cyclic loading conditions with a load step size of 7.5 minutes	135
6.4	(a, c) Torque (Nm) and (b, d) COF values for cyclic frequency conditions with a frequency step size of 600 rpm	136
6.5	Low magnification SEM images for Blend 1 grease containing ZDDP/PTFE wherein (a to f) represent the images from Test 1 to Test 6	138
6.6	High magnification SEM images for Blend 1 grease containing ZDDP/PTFE wherein (a to f) represent the images from Test 1 to Test 6	139
6.7	Low magnification SEM images for Blend 2 grease containing ZDDP/PTFE/MoDTC wherein (a to f) represent the images from Test 1 to Test 6 ..	140
6.8	High magnification SEM images for Blend 2 grease containing ZDDP/PTFE/MoDTC wherein (a to f) represent the images from Test 1 to Test 6 ..	141

LIST OF TABLES

Table	Page
2.1 Properties of Group 1 to Group 5 base oils.....	22
2.2 Properties of different lubrication regimes.....	25
2.3 Classification system for penetration of greases.....	30
2.4 Properties of different lubrication regimes.....	31
2.5 Performance features & application of greases as a function of thickeners	33
2.6 MoS ₂ particle size and properties.....	42
2.7 Physical properties of PTFE.....	48
3.1 Typical test data for Texaco Marfak [®] Multipurpose grease	58
3.2 An overview of grease formulations and additives used.....	59
3.3 Overview of different test conditions used in the research work.....	69
4.1 Overview of grease formulation and additives used	74
4.2 Overview of different test conditions used in the study	75
5.1 Overview of grease formulation and additives used	100
5.2 Overview of different test conditions used in the study	101
6.1 Overview of grease formulation and additives used	130
6.2 Overview of different test conditions used in the study	131

CHAPTER 1

GENERAL OVERVIEW

Since the onset of Industrial revolution in 18th century there has been an incredible progress with the way machines are designed and built to make them more reliable, increase their productivity and reduced maintenance. They are often used for long periods of time with less number of scheduled maintenance. Most of the machines built today are designed to operate at a wide range of temperature with an increased load bearing capability. This has frequently resulted in increased wear & tear, higher amount of heat dissipation which sometimes leads to replacement of machine parts and other peripheral components. There has been an ever growing necessity in the use of lubricants and a strong emphasis to develop high performance lubricants capable of meeting the operational requirements.

A lubricant can be defined as a substance which is used in machine parts to reduce wear, friction and lower the heat generated due to friction in between the moving parts. Lubrication can be defined as a process employed to reduce the wear & tear in between the moving parts that are in close proximity to each other by interposing a lubricant that helps to improve the load carried in between the surfaces. The properties possessed by a good lubricant would be: high boiling point, low freezing point, good thermal stability, corrosion and oxidation resistance.

Liquid lubricants, solid lubricants and semi-solid lubricants are the three most common class of lubricants used in day-to-day applications. Liquid lubricants generally use a number of anti-friction and anti-wear additives in the base oils; Solid lubricants are also known as Dry lubricants and are used in solid phase to reduce the friction and wear without the necessity of a liquid media. Semi-solid lubricants are generally used in those cases where it is not feasible to use the liquid lubricants. Liquid lubricants generally consist of AW (Antiwear) and EP (Extreme-

pressure) like ZDDP (zinc dialkyl dithiophosphate), sulfurized olefins, phosphorous additives, & ashless dithiophosphates along with anti-oxidants, rust & corrosion inhibitors, viscosity modifiers and dispersants. Solid lubricants generally consist of a lamellar or a layered crystal structure wherein the layers slide over each other owing to the presence of weak Van Der Waal's forces. Graphite, Molybdenum disulfide, tungsten disulfide, PTFE (poly tetra fluoroethylene), MoDTC (molybdenum dialkyl dithiophosphate) and talc are the most commonly used solid lubricants. On the other hand semi-solid lubricants consist of greases which are used for special applications where liquid and solid lubricants aren't effective. Greases generally operate under boundary lubrication regime and have reduced viscosity at higher operating temperatures improving its lubricity.

Greases can be best imagined as thickened oils along with other additives which can be chosen depending upon the specific purpose. Greases consist of soap-thickener fibers which forms long network of oil entrapment pockets. The lubricant oil present in these pockets is supplied to the surfaces in contact thereby lubricating the surfaces. Greases are used for lubricating vertical machine components and also act as a sealant which protects foreign impurities from entering the components. They are preferred in places where frequent lubrication is not necessary and conditions of shock loading seldom exist. The most commonly used greases consist of mineral oil and lithium based soap-thickener fibers.

The interacting surfaces appear to be a macroscopically smooth; however there will only be asperity contact that occurs in between these surfaces. On studying the surfaces closely we can find the presence of microscopic hills and valleys. Direct contact in between these asperities leads to increased friction, heat generation, enhanced wear and eventually welding under high loads. The lubricant seeps in all the microscopic features and decreases the contact area in between asperities leading to a lower friction coefficient and reduced wear. EP and AW additives are added to the greases to enhance the weld and wear performance of the greases. EP additives help in reducing contact seizure and an improved load carrying capability.

AW additives help in decreasing the wear of the surfaces. These additives interact with the surface to form a protective sacrificial film that protects the substrate from further wear & tear. The protective film is termed as a Tribofilm which can be formed by either physisorption or chemisorption. Additives like graphite and MoS_2 which have lamellar crystal structure form tribofilm by physical deposition of its shearable layers; on the other hand additives like ZDDP, phosphorous additives, thiophosphates react with the wear surface under pressure and temperature to form a tribofilm. It should be made sure that the additives don't form any corrosive byproducts which might deteriorate the lubricant performance. Any antioxidants added help increase the life of lubricants at elevated temperatures.

1.1 Objectives and Drive for the Research work

Greases are one of the oldest forms of lubricants present. The industry today strives to develop and test high performance greases which have wide application versatility and a longer service life. ASTM D2266 standard is employed as an industry standard for wear tests and is usually effective in screening of greases and lubricating oils. The ASTM D2266 standard is usually described as a Four Ball test and is typically run under fixed set of test parameters: 75°C , 1200 rpm, 40 kg load & 1 hour test [1]. However in real-world applications greases are subjected to varying conditions of temperature, frequent changes in the load and rpm as well. Hence high performance greases that are developed and tested under the ASTM D2266 standard may or might not give an optimum performance in real-world applications where there is a constant change in test conditions. In this study, tests are carried out under varying parameters to understand the effects of varying test conditions on the wear performance of greases. The varying test conditions are designated as Spectrum Loading conditions.

In current market, MoS_2 has been used as an EP additive in greases which are used in applications where low RPM and high loads exist. MoS_2 is usually added upto 5wt. % in the EP greases, however there are greases present for special applications which contain MoS_2 in fairly large proportions. They are employed in applications where shock loading conditions exist

or in places where there is a high load bearing necessity. While MoS₂ due to its layered lattice structure forms protective tribofilms due to the sliding of these layers, it is important to note that if the MoS₂ particle is not oriented in the direction of shearing of its layers, it would behave as a pro-abrasive agent due to the presence of sharp edges and corners; also the layers of MoS₂ might not shear at lower loads as it might not be sufficient to overcome the Van Der Waals forces of attraction existing in between the layers. Hence, at lower loads due to inability to shear the layers MoS₂ would behave as an abrasive rather than an additive. In this research we explore a way to reduce the abrasiveness of the MoS₂ particle while keeping intact its EP capabilities. An increase in the wear number due to the abrasiveness of MoS₂ especially due to its sharp edges and corners was demonstrated in the previous research [2], the current study explores a way of treating MoS₂ particles to get rid of the sharp edges and corners and tries to comprehend the effects of Spectrum Loading conditions on the wear performance of greases formulated using treated MoS₂. The research also develops and tests high performance greases meant to have EP and AW properties while being free of any MoS₂ particles. It will be later demonstrated in the study that the greases free of MoS₂ perform the best under spectrum loading conditions.

In the current study four different additive chemistries were blend and tested under spectrum loading conditions wherein the load and frequencies are systematically varied and the wear and friction outcome is studied. MoS₂ grease was tested under spectrum loading conditions and was treated as a baseline and compared with other blends to study the effect of particle morphology, the effect of additive chemistry and the effect of friction modifiers used in the study. The research work is focused on developing and testing high performance greases as alternatives to MoS₂ containing greases. In the real-world applications it is very likely that greases would be subjected to varying conditions of temperature, frequent changes in the load and rpm as well. Hence the screening of greases under fixed set of test conditions as prescribed by the ASTM D2266 standard might not be indicative of the performance of greases

close to real-life applications. In this study, tests are carried out under varying parameters to understand the effects of varying test conditions on the wear & friction performance of greases.

1.2 Outline of the Research work

This thesis is presented in a total of eight chapters. Following is a list of these chapters with a brief outline of contents present in the chapter.

Chapter 1: This chapter gives the reader a broad overview of the research work carried out. It also highlights the objectives and drive for the research.

Chapter 2: This is a background chapter and explains in depth all the fundamentals related to tribology and lubrication.

Chapter 3: The third chapter gives an in-depth description of the experimental approach, all the materials used and the protocols for different procedures and tests.

Chapter 4: This chapter compares the effect of milling of MoS₂ particles on the wear and friction performance of greases under Spectrum Loading Conditions.

Chapter 5: This chapter talks about the performance of an alternative grease which would give extremely good AW/EP properties without MoS₂ particles.

Chapter 6: This chapter talks about the effect of friction modifiers on the wear and friction performance of greases under Spectrum Loading Conditions.

Chapter 7: The seventh chapter summarizes the research work and discusses all the conclusions that can be drawn from the study.

Chapter 8: The eighth chapter suggests the future work that could be carried out and other options that could be explored.

CHAPTER 2

BACKGROUND

2.1 Tribology

Tribology can be defined as science and engineering of interacting surfaces that are in relative motion. It includes the study and application of principles of friction, wear and lubrication [3]. The word Tribology comes from the Greek word “*Tribos*” which literally means rubbing the surfaces. Tribology is a multi-disciplinary branch which spans from physics, chemistry to Mechanical and Materials science. Friction which can be described as the force opposing the motion of two interacting surfaces comes into play if the machine components are not properly lubricated which leads to wear and generation of heat.

2.1.1 History of Tribology

Principles of tribology have been known and used since thousands of years. The early human beings during the Stone Age used the principle of frictional heat generation for creating fire. During the Neolithic age (4000-1800 B.C) Egyptians and Sumerians used lubricants like crude oil, bitumen, animal fat for their chariots and other machines. For transportation of huge statues and other construction materials greases were used. This reduced the manpower by over 50% when no lubrication was used [4]. From about 300 B.C to 50 A.D the Greek and Roman engineers had designed the very first forms of what we know today as a roller bearing. They used it for supporting the battering rams on warships and used them over the axles to mount wheels on them which significantly reduced the friction and wear. By late 15th century, Leonardo da Vinci studied the coefficient of friction and formulated laws of dry friction [3]. He also replaced the rollers to balls which were to be used in bearings. During the period of Renaissance many prominent researchers across Europe like Isaac Newton, Leonhard Euler and Charles Coulomb studied the fundamentals principles of tribology; Coulomb developed

several models to understand friction coefficient and from his studies he concluded that smoother the surface, smaller is the friction coefficient. He also determined that friction is independent of area of contact and is a function of surface roughness. During the 18th century the ball bearing was perfected and was used for axles for horse carriages. From the onset of Industrial revolution from mid-18th century tribology achieved its prominence and a lot of emphasis was given to study, understand and design the machine components which had low wear & tear and energy efficient. In 1966 a study was commissioned by the British govt. to study the wear and energy losses that occur in the machine components used in the industries. It was during this time that the word Tribology was officially coined [5]. In 1985, ASLE (American Society of Lubrication Engineers) was officially renamed as STLE (Society of Tribologists and Lubrication Engineers). During the last couple of decades tribology has been considered a branch of Mechanical engineering, although tribology spans over multiple fields. In the last decade there has been a tremendous amount of research and progress that has gone into tribology and lubrication to make the machines more efficient and reliable.

2.1.2 Interdisciplinary aspects

Although tribology has been classified as sub-branch in mechanical engineering, it spans over multiple disciplines. Below is a picture which shows how tribology interacts with other sciences. Tribology comprises the fields which include Mechanical engineering, Materials science, Chemistry and Technology. The mechanical aspects consist of contact geometry analysis, wear and friction studies. It also involves proper designing of machine components before it is used in the industry. Materials science involves more of materialistic aspects that include choosing of the right materials which have the lowest coefficient of friction, analysis of the wear surface and wear volume and using various characterization techniques to understand the chemistry of the tribofilm formed on the surface. Chemistry has more to do with the formulation of lubricants and choosing the right additives which give the lubricant an optimum performance. Technology aims at implementation of tribological knowledge which would result

in reduction of wear and optimization of friction. The operational reliability of machines and installations is increased, production costs are reduced, resources and energy are saved and emissions are decreased. Surface physics also plays an important role as one has to understand the type of physical changes that occur at interfaces.

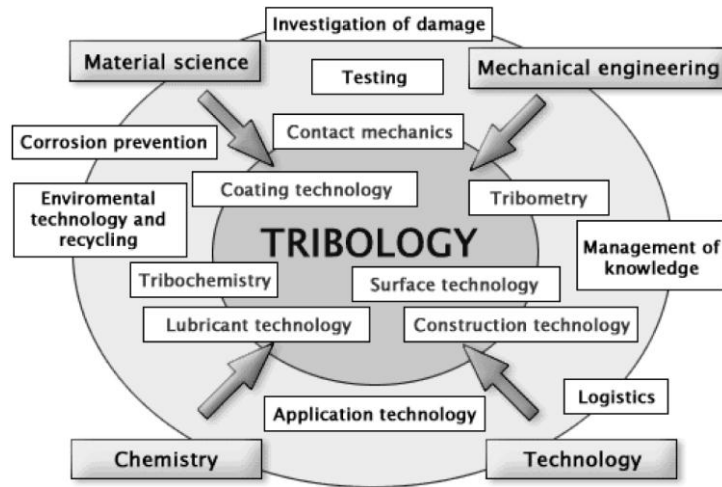

Fig 2.1 Graphic description of interaction of tribology with other sciences [6]

2.1.3 Tribological system

A tribological system consists of six main components as mentioned below [6]. When the surfaces of two components which have relative motion with respect to each other, all these components come into play. The type, progress and extent of wear are determined by the materials used, the surface finish of the components, intermediate materials which might include the wear debris and foreign impurities, surrounding influences and operating conditions.

The six components as labeled in the picture are as mentioned below.

1. Base object
2. Opponent body
3. Surrounding influences: Temperature, relative humidity, pressure
4. Intermediate material: Oil, grease, water, Particles, contaminants
5. Load
6. Motion

The base and the opponent object are the two interacting surfaces and depending upon their surface roughness and the type of material the coefficient of friction varies. Factors such as temperature, pressure, humidity do play a significant role on tribological testing of lubricants.

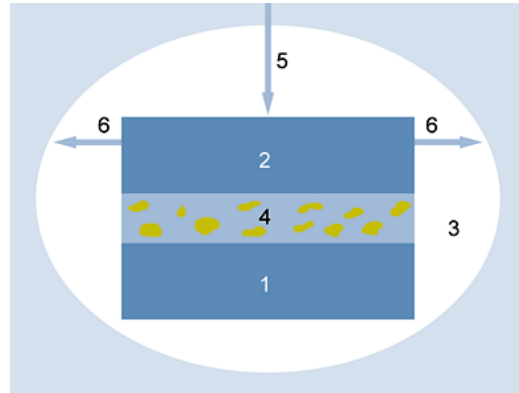

Fig 2.2 A pictographic representation of Tribological system [7]

Lubricants used in aerospace applications are expected to operate at wide range of temperature. Some of the additives used in greases that are susceptible to moisture can have deteriorating effects on its performance. When high loads are used suitable additives must be included so as to make sure that they perform well in EP (extreme pressure) conditions; however the fluid friction should be minimized when using low loads so that optimum conditions exist wherein there is no viscous drag and at the same time still providing protection against wear.

2.2 Friction

Friction can be defined as a resisting force that acts tangential to the interface between two bodies when, under the action of external force one body moves or tends to move relative to the other. Frictional force can be considered as a good as well as bad force; good because cars can be driven by the virtue of friction in between the wheels and road surface, rail-road transportation is possible and we could run or walk due to the presence of friction. However in most of the cases, frictional forces are detrimental. In machine components, friction leads to

wear and tear of the machine as well as heat is dissipated which reduces the overall efficiency of the machines.

2.2.1 Laws of Friction

There are three basic laws of friction which were postulated from 15th to 18th century.

They are as mentioned below:

- First law of Friction:

Friction is proportional to the normal force between surfaces. When two bodies are in contact the direction of the forces of Friction on one of them at its point of contact, is opposite to the direction in which the point of contact tends to move relative to the other. Mathematically it can be represented as:

$$F_f = \mu N$$

Where, F_f = Force

μ = Coefficient of Friction

N = Normal load

The coefficient of friction is an inherent property of the interacting materials. If the surfaces are at rest relative to each other, frictional force is equal to the force that would be needed to prevent motion between two surfaces. The coefficient of friction is then called coefficient of static friction. If the surfaces are in relative motion, the frictional force on each surface is exerted in the direction opposite to its motion relative to the other surface. The coefficient of friction in this case is known as the coefficient of kinetic friction. Frictional force always acts in a direction opposite to the applied force.

- Second law of Friction:

Friction is independent of the apparent area of contact. At a microscopic level the surfaces are generally wavy & bumpy; hence the two surfaces that are shown in contact never completely touch each other. The upper body is supported by the lower body surface at the surface asperities which form the top of roughness irregularities. Under

load, these asperities bend and deform until the load is fully supported. Friction is indirectly proportional to the real area of contact. Since this is a small share of the total area, friction is effectively not dependent on the apparent area of contact. However for extremely clean and highly friction is not independent of the apparent area of contact. In this case real area of contact would become a significant portion of the apparent area of contact. The amount of limiting friction is independent of the area of contact between the two surfaces and the shape of the surfaces, provided that the Normal reaction is unaltered.

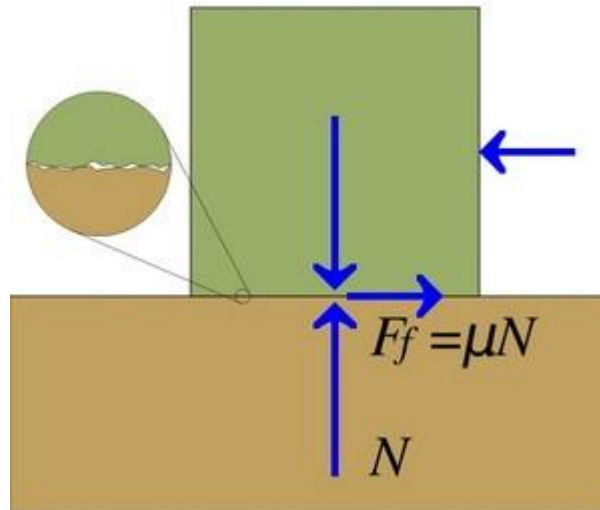

Fig 2.3 Representation of frictional forces in play

- Third law of Friction:

The resisting force that occurs between moving bodies known as Kinetic friction, is independent of the velocity. When there is motion in between two bodies the direction of friction is opposite to the direction of relative motion and is independent of velocity. It is essential to distinguish the surfaces on the basis of lubrication from lubricated non-lubricated surfaces. In the case of lubricated surfaces a layer of lubricant separates two surfaces. However there is an exception to the third law; friction is not always

independent of velocity. At very high speeds, the friction coefficient generally has a slightly negative slope; that is, the friction coefficient decreases gradually as the speed increases. At very low speeds, the friction coefficient generally increases gradually with a decrease in sliding velocity [8].

2.2.2 Asperities and Stick-slip phenomenon

Most of the interacting surfaces in reality are not as smooth as they appear on a macroscopic scale. However on close examination using analytical tools on a microscopic scale, these surfaces appear rough and show “peaks” & “valleys” on high magnification images of the surface. These surface features consist of a wavy surface having peaks and valleys. When two bodies are placed over each other only the tips or the high points on the surface come in contact. On increasing the normal applied load slowly, elastic deformation of the surface features begins. These features are termed as asperities which range from a couple of micrometers to hundreds of nanometers. On increasing the load, the pressure at the contact point also increases till the elastic limit of one of the materials is reached and plastic flow starts. Thus, the asperities would undergo plastic deformation at significantly small loads till the area of contact is sufficient enough to support the load. Since the tips of the asperities are points where the surfaces make contact, the pressures are very high. Such high pressures cause the asperities to weld. As the surfaces slide over each other, the welded junctions are sheared [9].

Friction and wear originate at these points and thus understanding their behavior becomes important when studying materials in contact. Asperity interaction results in dissipation of frictional energy by numerous processes which are demonstrated by changes in structural aspects on the sliding surface. Frictional heating is a major energy sink during frictional sliding and leads to thermal issues in machine components [10].

Friction can manifest itself as rolling friction or sliding friction where any two plain surfaces move relative to each other as observed in an IC engine wherein the piston rings glide against the cylinder walls leading to sliding friction. During the sliding motion of the two

surfaces, a phenomenon called “Stick-slip” also occurs [11]. On the macroscopic level, this phenomenon appears very steady, however in reality this motion is intermittent or jerky as the surfaces slow down during the shearing of the asperities at the contact point, and eventually they accelerate.

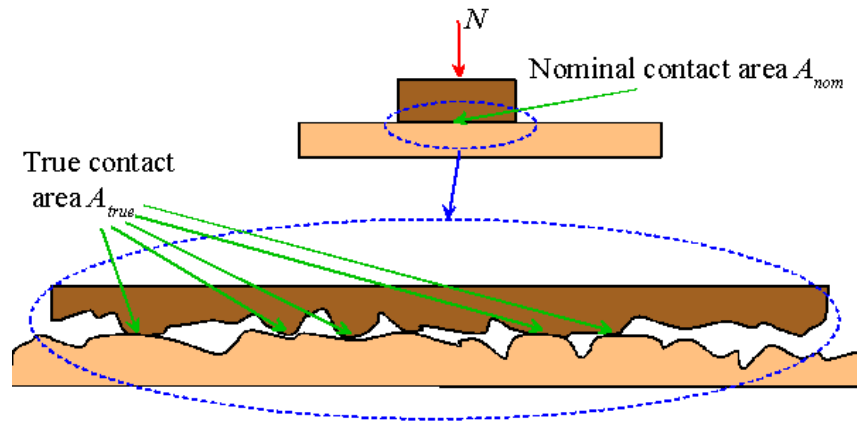

Fig 2.4 A pictographic representation of surface asperities [10]

This happens if the coefficient of kinetic friction is less than the coefficient of static friction. Stick-slip mainly occurs because static friction in most case has a higher value than kinetic friction. When a force is applied to the part to be moved, the force should be large enough to overcome the static friction. This sets the part in motion; when motion begins, the kinetic friction is generally lower than the static friction. The stationary part of the system has been deflected due to its elasticity by this frictional drag, and the sudden reduction in frictional drag causes it to rebound and stick to the moving part. This leads to an intermittent relative motion called Stick-slip [12].

In classical mechanics, stick-slip can be illustrated by an example as shown in Fig 2.5; V stands for the motor or the drive system, R stands for the elasticity, M stands for the mass or the load that is to be moved. As the drive system rotates, the elasticity in the spring slowly increases upto a point where in it exceeds the force that is needed to overcome static friction coefficient and hence the mass M moves.

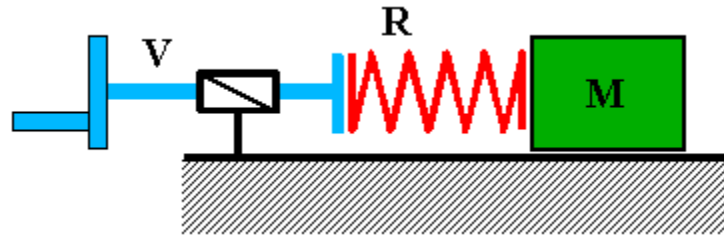

Fig 2.5 A classic illustration of Stick-slip system [8]

As M is pushed it accelerates in the beginning; however when the elasticity stored in the spring drops down due to the motion of M, the force is no longer sufficient to overcome the static friction coefficient and hence the motion of mass M stops. This process continues as the drive system operates and stores elastic energy in the system.

2.2.3 Adhesion theory of friction

Adhesion theory is the commonly accepted theory regarding the cause of friction. When two surfaces are brought into contact and a load is applied forcing them together, asperities come in contact. The total area of contact of these junctions is a function of load and the penetration hardness of the softer material. If the surface is very clean and outgassed surfaces high friction coefficients of around 1.0 are observed as the real contact area is further increased and surface energy contributes a significant component to the friction. Surface roughness and electrostatic effects are some other factors contributing to friction force. It decreases for smooth surfaces because of the increase in real contact area and it does increase for rough surfaces because of asperity interlocking. The factor of electrostatic attraction occurs only for dissimilar materials, and generally is extremely small. For practical purposes friction can be considered as a sum of adhesive force, a force caused by surface roughness and possibly a small component of an electrostatic force. The most effective ways to optimize friction are the selection of the materials, using lubricants, and optimization of surface roughness.

Fig 2.6 shown below represents adhered layers of foreign material to the surface of the base metal substrate. True contact in between two surfaces occurs only at small areas

dispersed over the nominal area of contact. Most of the case under load, adhesion occurs between the surfaces at these contact areas and that the frictional resistance to sliding is due to the force required to overcome the adhesion.

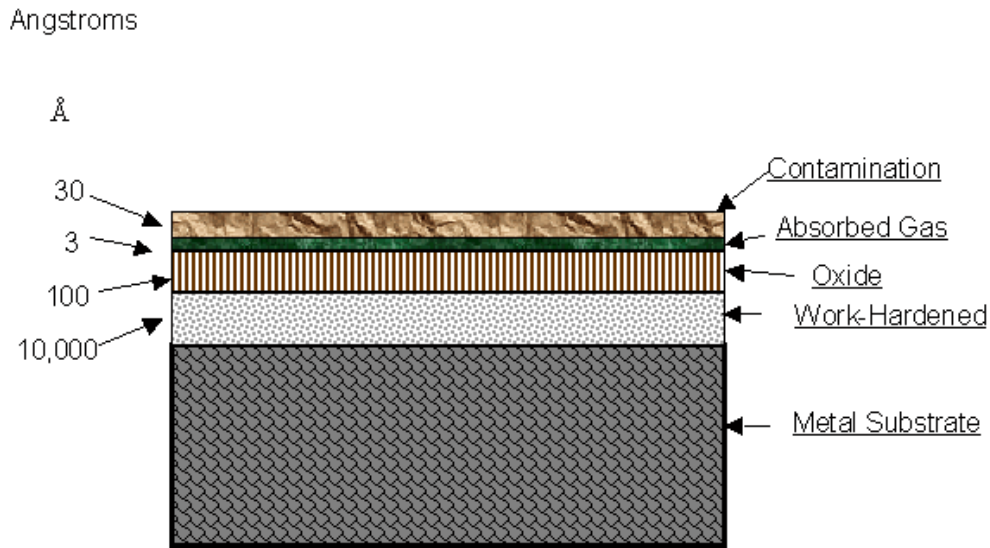

Fig 2.6 Foreign materials adhered to the metal substrate [13]

This theory however has been challenged by Bowden et al [14] who suggested that when the normal load is removed elastic recovery of the surface breaks the junctions formed at the localized contact points or areas and hence adhesion is not detectable. It was also proved in their study that the static friction is due to adhesion between the specimen and the opposing surface, and that elastic recovery of the surfaces on removal of the load tends to reduce the friction.

2.3 Wear

Wear can be defined as undesired removal and deformation of material from the surface due to mechanical action of the opposite surface. Wear and friction are related to each other, changing one of them alters the other. Some of the most common ways of reducing wear are: Lubrication, using surface/sacrificial coatings and proper designing of machine components

which ensures less wear and tear. Wear in machine components can be monitored by measuring the weight loss, increase in the wear volume wear surface analysis.

2.3.1 Mechanisms of Wear

Modern literature identifies twelve different kinds of wear mechanisms. They are: mild adhesion, severe adhesion, abrasion, erosion, and polishing, contact fatigue, corrosion, fretting corrosion, electro-corrosion, brinelling, electrical discharge and cavitation damage. However the most commonly operating mechanisms Adhesive wear Fatigue, Abrasive wear and corrosive wear [15].

2.3.1.1 Adhesive wear

Adhesive wear can be defined as the transfer of material from one of the interface to another interface and is accompanied with the formation of adhesive joints or welds at the contact areas of the interface. It occurs under high loads, high temperatures and extreme pressures that cause asperities on the interacting surfaces, in relative motion to spot-weld together for a short time and then split apart, which results in shearing of the material in small discrete areas. Adhesive wear is generally avoided using lower loads and avoiding shock-loading conditions.

During sliding, the junctions are sheared which does occur at the interface. Occasionally shearing might occur in one of the two interface materials. This results in transfer of a wear fragment from one surface to the other. Some junctions which are stronger than the base metal plastic yielding and work hardening might occur. Adhesive wear is characterized by the transfer of materials from one surface to another; some material might transfer back to the original surface or might results in breaking off the wear particles that are loosely bonded [12].

2.3.1.2 Abrasive wear

Abrasive wear can be considered as one of the most common type of wear that occurs in machine components. This wear mechanism comes into picture when there are two interacting surfaces directly in physical contact and when one of them is a lot harder than the

other. There are two sub-divisions in abrasive wear: Two body abrasive wear wherein hard particles embedded in a hard material pass through the softer material leading ploughing grooves and behaves similar to a cutting tool. On the other hand Three-body abrasion occurs when the grits or other wear debris is free to roll, slide and scrape over the surface as they are not constrained.

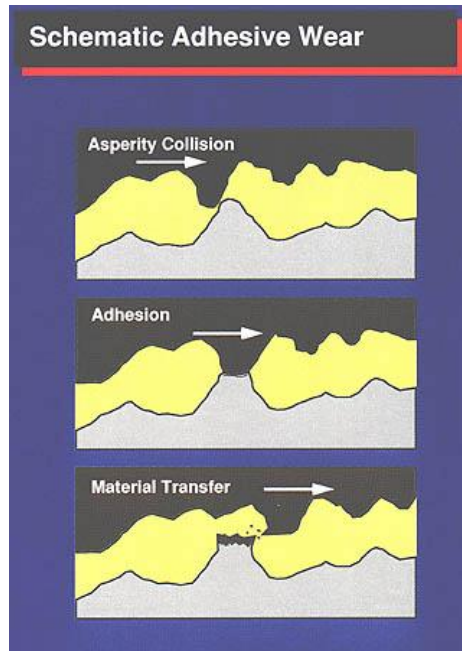
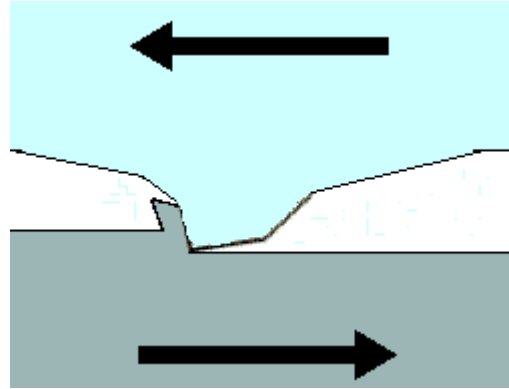

Fig 2.7 A representation of Adhesive wear mechanism [15]

2.3.1.3 Corrosive wear

The most common cause of corrosive wear is due to a chemical reaction between the worn out material on the surface and a corrosive environment which might be a chemical compound, toxic substance caused due to a reactive lubricant or humidity in the air. Due to the corrosive environment the surfaces in contact react with it leading to the formation of reaction products which might be adhered to the surface or might be suspended in the lubricant. If the reaction products are adhered to the surface it reduces the corrosion, however due to the wear that occurs the adhered layer is removed thus exposing the surface and resulting in corrosion of

the fresh exposed surface. If the corrosive products are hard enough, they act as abrasive particles and lead to abrasive wear mechanism as well.



(a)

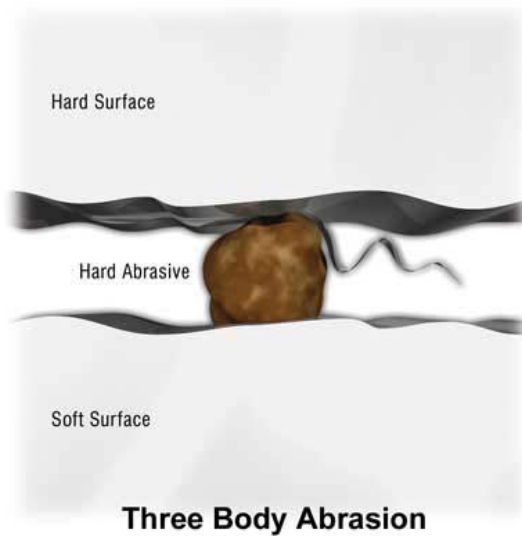

(b)

Fig 2.8 Illustration of (a) Two body abrasive wear (b) Three body abrasive wear [16]

Some of the ways to resist corrosion are to use more corrosion resistant material, reduced operating temperature and elimination of corrosive environment. Corrosive wear also leads to formation of pits forms galvanic cells and leads to further corrosion. Water contamination is the most common cause of corrosive wear.

2.3.1.4 Fatigue

Fatigue can be defined as a progressive and localized structural damage when a material is subjected to repeated loading cycles. Fatigue is a phenomenon which is accelerated due to high temperatures, increased load cycles and a presence of a corrosive medium. Fatigue generally progresses steadily till the last part of material holding onto the surface is unable to support any more load cycles and the material usually fails rapidly in the end.

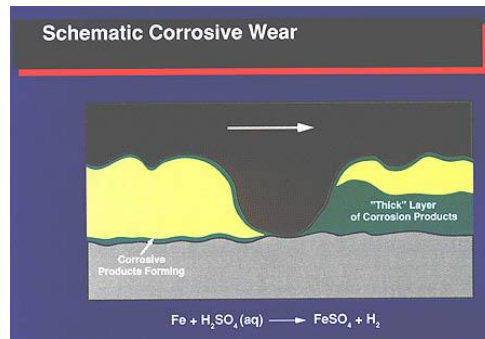

Fig 2.9 A schematic representation of corrosive wear [15]

Fatigue wear is generally related to rolling contacts, as in the case of bearings, due to the presence of cyclic loads. Sliding surfaces are more susceptible to adhesive wear and they occur rapidly as there is little time for fatigue wear to occur.

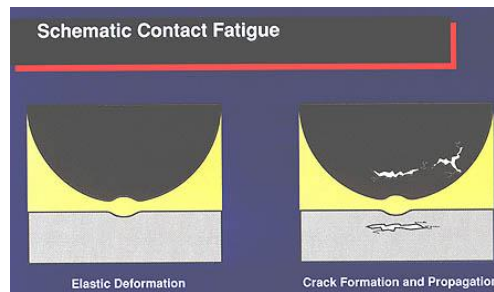

Fig 2.10 Illustration of contact fatigue [15]

Metal removed by cracking and pitting, due to cyclic elastic stress during rolling and sliding. Fatigue wear is seen when there is a repeated sliding or rolling that occurs over a wear track. The motion of balls or rollers in the bearing is a common example. Every time the ball or

the roller passes over the raceway it is stressed and relaxed. Even though it can be argued that the stress reversals would be within the elastic limits of the material, it would crack eventually.

The cracks may be initiated on the surface or below the surface of the two bodies in contact. With passing of the time, these micro-cracks coalesce and result in the formation of a large crack that will eventually remove a large piece of material leaving a pit or a large hole. Gear teeth's are prone to this type of wear mechanism.

2.3.2 Stages of Wear

The wear process consists of three stages which can be classified as the start-up regime, the steady-state regime and catastrophic wear. In the start-up regime the wear process initiates; this stage is also called as a break-in stage during which high wear rates are obtained as the asperities present on both the mating surfaces abrade the other surface which generates conforming surfaces and an increased area of contact. This results in load being distributed over larger areas. In a lubricative contact environment the early break-in stage would correspond to the regime when protective tribofilms haven't formed yet. High friction coefficient and higher wear rates are generally associated with this regime. This provides necessary conditions for the additive chemistries to activate leading to the formation of tribofilms. Break-in time is normally short as compared to the steady-state and catastrophic regime.

Steady-state regime is associated with lower wear rates & is where stable friction coefficient values exist for most of the service life of the machine component. A protective tribofilm is formed on the areas of contact that constantly undergoes wear and it replenishes. The formation of the tribofilm in a lubricated system reduces the wear of the components as the tribofilm behaves as a sacrificial layer protecting the metal substrate against further wear and shearing forces.

The steady state regime will continue to exist as long as the lubricated films continue to form, get worn out and replenish by a fresh layer which protect the wear surface. When the lubricant is no longer able to form the tribofilms the material wear starts again and it enters into

the catastrophic regime. In the catastrophic regime which is a final stage in the wear of the material is usually associated with high rates of wear and severe damage to the surface leading a component to fail or replacement. However, the damages which occur to a machine component before failure are not the characteristic of the steady-state wear of the material or the AW properties of the lubricant which is used in the tribo-system and thus cannot explain the series of regimes or the events that occur which leads to failure of the component.

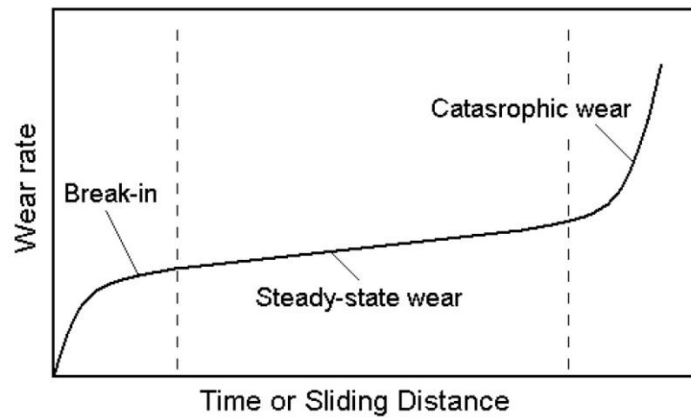

Fig 2.11 Different stages in wear of a machine component [17]

Degradation of the lubricant could be one of the reasons for the failure of the machine component. The lubricant might run-out of the AW or EP additives which might lead to the failure to replenish the tribofilm leading to excessive wear and ultimately failure. Lubricant can also fail due to oxidation or contamination by wear debris, soot or other impurities. Also if the service conditions keep changing constantly then it might have an effect on the lubricant performance which might lead to failure of the lubricant as well [18].

2.4 Lubrication

Lubrication can be defined as a process or a technique employed to reduce wear on the interacting surfaces by using a lubricant. The lubricant present in between the interacting surfaces carries the load and the additives present in the lubricant help in improvement of properties like weld load, EP, rust and corrosion inhibition. The process of lubrication and usage

of lubricants has been in practice since hundreds of centuries. Animal fats and crude oil were used around 1400 BC as lubricants for moving heavy weights or structures and also for the wheels of chariots. From 1852 petroleum-based oils were made available. After the onset of industrial revolution there was an ever growing demand due to the usage of new machine tools and improvements in automotive technology. During this time the lubrication industry was on a steep learning curve and a lot of effort was made to understand the additive chemistries and crude oil distillations as well. Society of Automotive Engineers (SAE) set the standards for the engine oil in 1923. These oils had to be replaced or replenished every 1000 miles as they had no additives. Liquid lubricants today have evolved from conventional mineral-oil based to synthetic oils and the base stocks have been classified as Group 1 to Group 5. By 2008, most of the lubricants available in the United States were made from Group II or Group III base stocks [19].

Table 2.1 Properties of Group 1 to Group 5 base oils [4]

Group Designation	Composition	Viscosity Index	Volatility %	Polarity	Viscosity / Pressure (α)	Solvent for Additives	Pour Point °C	Flash Point °C	EHD Characteristics	Price (1-10)
Group I	Distilled, solvent refined: $\geq 10\%$ aromatics, $< 90\%$ saturates	80-119	15-20	med-high	> 20	good-exc.	-5 to 15	100	med	1
Group II	Distilled, solvent refined, hydro-cracked: $< 10\%$ aromatics, $\geq 90\%$ saturates	80-119	10-15	med	> 20	good	-10 to -20	170	high	1.05
Group III	Distilled, solvent refined, severely hydro-cracked: $< 10\%$ aromatics, $\geq 90\%$ saturates	≥ 120	5-15	med	16-20	good	-10 to -25	190	med	1.5
Group III+	Group III+ oils are additionally hydroisomerized, or processed in other ways: $< 1\%$ aromatics	≥ 140	≤ 5	low	16-20	good-poor	-15 to -30	200	med	2
Group IV PAO	100% catalytically synthesized from olefins derived by thermally cracking wax	135-140	1.8	low	13	poor	-53	270	low	2.5-3
Group V Polyol Ester	100% synthesized by reacting acids and alcohols	140	1.0	high	> 20	exc.	-21	260	med	5-10

The lubricant selection criteria include screening a number of parameters. Some of them are operating environment, viscosity & fluid film lubrication, boundary lubrication

performance, stability under service conditions, fire & corrosion resistance, compatibility with the interacting surfaces, biodegradability & toxicity and additive susceptibility.

2.4.1 Lubrication regimes

The thickness of the fluid film determines the lubrication regime. There are four main types of lubrication regimes: Hydrodynamic lubrication, elastohydrodynamic lubrication, mixed lubrication and boundary lubrication. Mixed lubrication is known to have the least coefficient of friction.

Hydrodynamic and elastohydrodynamic regimes can be classified under fluid film lubrication regimes wherein a film of lubricant separates the interacting solid surfaces in a tribological system. The fluid film supports the load. The properties of lubricant like its viscosity, load bearing ability determine the effectiveness of the lubricant. Hydrodynamic lubrication occurs when two surfaces are entirely separated by a fluid film and no contact is possible. The most common example of hydrodynamic regimes is the journal and thrust bearing. On the other hand elastohydrodynamic regime is observed in gear teeth and cams wherein the surfaces are separated by a very thin film of lubricant. Under this regime there is an elastic deformation that occurs on the interacting surfaces due to high loads on the surfaces. When rollers and ball elements used in a bearing rotate in a cage at high velocity and load there is an elastic deformation on the cage that occurs every time the ball or roller element passes over it. Under high load conditions, the viscosity of the fluid film becomes a function of the load and its thickness becomes independent of the load at the contact point or the contact area [20]. Under sever loading conditions when the fluid film is no longer supportive of the load, the surface asperities come into contact and the lubrication regimes passes into the mixed lubrication regime [9].

The third lubrication regime is called as Boundary lubrication regime which is seen at high contact pressures and low sliding speeds which results in interaction in between asperities which collide against each other and undergo elastic & plastic deformation leading to cold

adhesion and material transfer. Even in the case of fluid film lubrication, at the start up and stopping boundary lubrication regime exists. When there is an interaction in between asperities which results in wear exposing fresh surface; the AW (anti-wear) and EP (extreme-pressure) chemistries present in the lubricant that are activated at high temperatures and loads form protective tribofilms at these worn out surfaces. These tribofilms keep wearing out and replenishing as far as the lubricant doesn't degrade thus providing protection to the substrate material. In boundary lubrication regime, the additives present in the lubricant as well as properties of the interacting surfaces direct the lubrication performance. Tribofilms can be categorized as anti-wear and low friction films. However in real-life applications most of the tribological systems comprise of varying size of asperities which when in contact, a number of stresses are produced around and in the contact zone. In such scenarios a mixed regime of boundary and elastohydrodynamic lubrication do exist [21].

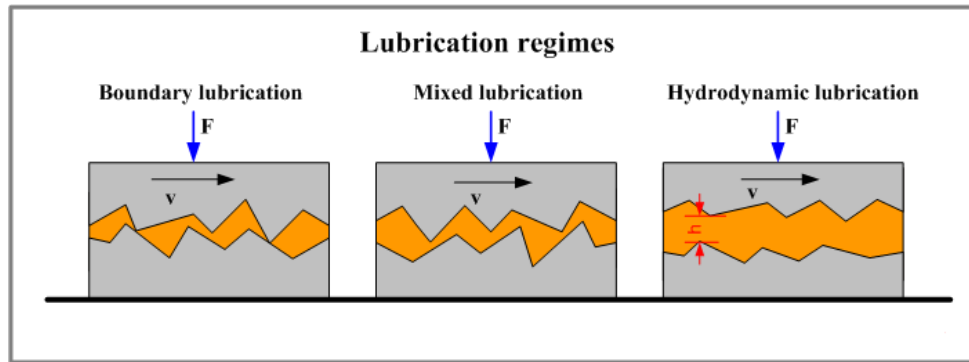

Fig 2.12 Representation of different regimes of lubrication [22]

Figure 2.11 shows the different regimes of lubrication; Parameter "F" stands for the load carried by the interface, "v" is the velocity of the interface and "h" stands for the separation in between the interfaces. For Hydrodynamic lubrication " $h \gg$ height of the asperities", for Boundary lubrication " $h <$ height of asperities", for the case of Mixed lubrication " $h \sim$ height of asperities"; the table 2.2 compares the properties of different lubrication regimes.

Lubricants can be classified into four categories namely: Oils, greases, solid lubricants and gases. Oils can be further sub-divided petroleum or mineral oils, animal & vegetable oils

and synthetic oils. There are three categories of mineral oils: Paraffinic oil (contains straight chain hydrocarbons), Naphthenic oils (contains cyclic carbon compounds with no unsaturated bonds) and Aromatic oils (contains aromatic compounds which have alternative double bonds similar to benzene ring structure). Synthetic lubricants were developed from PAO (polyalphaolefins) to be used in wider operating conditions especially in aircraft engines. They can be operated in temperature ranges of -50°C to 250°C; mineral oils obtained from crude oils oxidize at high temperatures while wax separation occurs at low temperatures.

Table 2.2 Properties of different lubrication regimes [9]

Lubrication Mechanism	Film thickness "h" (μm)	Coefficient of Friction
Hydrodynamic Lubrication	1-100	0.001-0.01
Elastohydrodynamic Lubrication	0.01-10	0.01-0.1
Mixed Lubrication	0.01-1	0.02-0.15
Boundary Lubrication	0.005-0.1	0.03-1

Some of the functions of the lubricant apart from reduction of wear and providing a low coefficient of friction would be:

- Reduction in the maintenance and running cost of the machine components.
- It acts as a coolant & leads to reduction in the loss of energy in the form of heat.
- Increases the efficiency of the machine components by reduction in wear & tear
- It acts as a sealant, preventing the entry of foreign particles in between the interacting surfaces.
- The anti-corrosive additives lead to minimizing corrosion.

Solid lubricants are another special class of lubricants used in conditions conventional lubricants cannot be used to deliver an optimum performance. Graphite and molybdenum disulfide are the two most commonly used solid lubricants. Due to their lamellar structure these materials can orient themselves in a direction parallel to the interacting surface in the direction of motion of the surfaces. Among the other materials used as solid lubricants are PTFE,

tungsten disulfide, talc. Gases can also be used as lubricants in gas bearings, however it should be made sure that the gases used doesn't decompose and attack the bearings [2].

2.4.2 Stribeck curve

The Stribeck curve has been named after a German engineer Richard Stribeck (1861-1950) who published his findings in 1902. The graph presented by him clearly showed the smallest value of friction as the delineation between full fluid-film lubrication and some solid asperity interactions [23]. The Stribeck Curve is a graph which relates friction with respect to viscosity, speed and load on the interacting surfaces. Coefficient of friction is plotted on the vertical axis whereas the horizontal axis is a plot of a parameter that combines the other variables: $\mu N/P$; wherein " μ " stands for the fluid viscosity, " N " stands for relative speed of the surfaces and " P " stands for the load on the interface per unit width of the bearing.

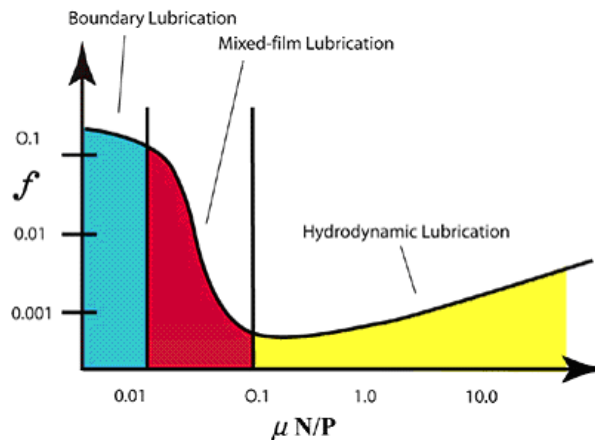

Fig 2.13 Stribeck curve showing different lubrication regimes [24]

As one moves from the from left to right on the horizontal axis the coefficient of friction slowly increases due to the viscous drag in between the lubricant layers. As we move to the left on the horizontal axis, the effects of asperity contact and boundary lubrication is seen wherein the coefficient of friction tremendously increases. Most of the tribological systems try to have a combined mixed film and hydrodynamic lubrication regime so as to keep the coefficient of friction as less as possible.

As there is an increase in speed & viscosity or a corresponding decrease in the load, the surfaces begin to separate and a fluid film starts to be formed. This lubrication film is very thin to start with initially, however it starts to support more and more of the load. This leads to mixed lubrication regime and the coefficient of friction begins to drop gradually as a result of reduced surface contact and a thicker lubrication film. From this point on the interacting surfaces will continue to separate as there is an increase in the speed or viscosity until there is a full fluid film and no surface contact.

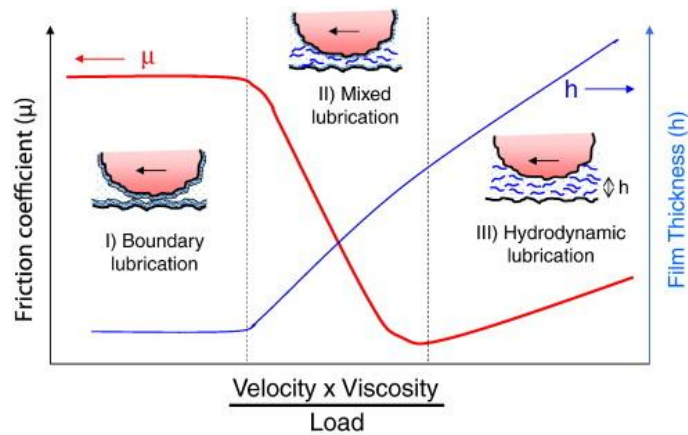

Fig 2.14 Stribeck curve showing the relation in between friction coefficient and separation in between the layers [19]

The coefficient of friction thereby reaches its minimal value and the transition from mixed regime to hydrodynamic lubrication regime occurs. In the hydrodynamic regime the load on the interface is completely supported by the lubrication fluid film. There is no asperities contact and a very low friction coefficient. However as the thickness of the lubrication film continues to grow the fluid drag or fluid friction comes in and the coefficient of friction starts to increase slowly. Boundary lubrication regime is seen on the machinery at the start-up and during shutdown where in low speeds and thin films exist. The machine will see more wear and tear during the startup and shutdown.

2.5 Greases

Greases can be defined as semi-solid lubricant that possesses high initial viscosity. The ASTM standard specifies lubricating greases as a solid to a semi-fluid product of dispersion of a thickening agent in the liquid lubricant [2]. Greases are one of the oldest forms of lubricants dating back to 1400 B.C wherein ancient Egyptians used crude greases made up of animal fat mixed with lime for lubricating the wheels used in their chariots. However after the industrial revolution in 18th century there was a need to develop greases which could be used at high pressures, longer durations and a varying range of temperatures [25,26].

Grease is a semisolid lubricant that consists of thickeners dispersed in mineral or vegetable oil along with other additives. Greases are applied in those mechanisms where lubricating oil can't stay in place and where frequent lubrication is not necessary. Greases also prevent inflow of the water and other incompressible material. Greases will not generally leak away from the point of application. Lithium based grease constitutes about 50% of the market [27]. The thickener gives the grease its consistency and provides small pockets of entrapped oil that is supplied to the lubricating machine parts. The thickener used in most of the modern greases is generally a soap that is a metallic salt of fatty acid and makes up about 4–20% of the volume. Some of greases use thickeners that comprises of clay or a polymer [28]. Greases are commonly used industrial lubricants which are known to provide low friction, are easily confined as well as have a long lubricating life at a low cost [29].

A lot of effort has been put in studying the film thickness of greases inside the contact, measurement of the frictional force [30], aging studies and grease degradation phenomena [31,32]. There is a lot of scope for grease research concerning film thickness formation and the useful life or the remaining life of the lubricant [33,34]. There are not many studies being published in the literature related to the mechanism of the film formation, the grease feed at the point of contact, and the association between the complex internal structure of the grease and its lubricant properties. Greases do have a complex behaviour as compared to lube oils [35].

Several studies aimed at understanding the relationship in between composition of greases and the corresponding film thickness have established that when the contact surface is under fully flooded condition, it leads to an increase in the viscosity of base-oil as well as the percentage of soap or thickener concentration that results in a lubricating film of greater thickness [36-38]. A couple of instances wherein greases are chosen over oil are when greater film thickness is necessary, frequent lubrication is not required, vertical machine components need to be lubricated and an application wherein sealing action of grease is necessary.

2.5.1 Grease composition and properties

The three main components of grease are: Base oil, thickeners and additives. The base oil accounts for about 60% to 98% of the grease composition and oils ranging from mineral oils, synthetic oils and animal or plant oils can be used. Commonly used synthetic oils for this purpose are PAO, esters, silicones. The naturally derived oils can be made up of soy oil, and vegetable oils. The viscosity of the base oil directly affects the viscosity parameters of the grease produced.

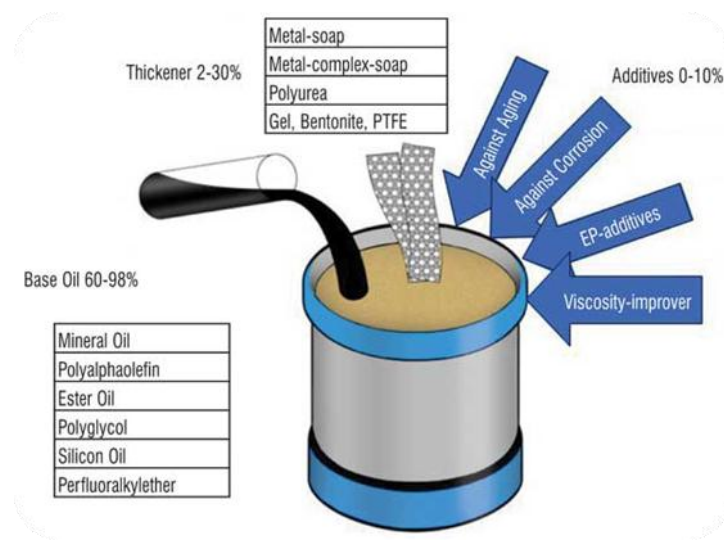

Fig 2.15 Grease composition [39]

The thickeners used are generally application specific and a majority of alkali based thickeners include lithium hydroxide, calcium hydroxide, sodium hydroxide, and aluminum

hydroxide. The alkalis are made to react with various materials derived from animal, marine, and vegetable sources. Non-soap thickeners can be used as well which include silica, clays, urea, polyuria & Teflon [39]. Most of the modern greases consist of an additive package which optimizes the properties of the grease which enhances its oxidation resistance, stability of the grease, increased operating temperature range, AW & EP properties [26]. A couple of properties of greases that the formulators as well as the industry keeps in mind are consistency, stability, EP/AW properties, pumpability, corrosion resistance and water tolerance. Consistency of the grease is one of the most important properties which are measured by a process known as worked penetration.

Table 2.3 Classification system for penetration of greases [40]

NLGI Grade	Worked Penetration
000	445-475
00	400-430
0	355-385
1	310-340
2	265-295
3	220-250
4	175-205
5	130-160
6	85-115

Consistency of greases is being defined by ASTM standards in a test known as worked penetration. The grease is worked for 60 strokes as prescribed by the standard and penetration depth is measured which is the distance in millimeters that a standard cone will penetrate a grease sample upon applying a standard force. This method is as described in ASTM D217 [41]. The stability of grease is another important property which is a function of temperature.

Greases can be thought of as thickened lubricants only at low or moderate temperatures, however at higher temperatures, their viscosity drops and they turn fluid. ASTM D2265 [42] standard measures the resistance of the grease to flow as temperature is slowly increased. This is termed as the dropping point. The dropping point is the measure of the heat resistance of the grease. In this test a grease sample is taken and packed into a test cup as specified by the standard which has a small opening. The sample is heated by introducing it into a preheated aluminum block.

The sample temperature added with one-third of the difference between that temperature and the block temperature when the first drop of fluid leaves the cup is defined as the dropping point. The guidelines for the maximum usable service temperature and ranges for dropping points of greases made with various thickeners are summarized in Table 2.4 [43].

Table 2.4 Properties of various thickened greases [26]

Thickener	Dropping Point (°F)	Max. usable service temp (°F)
Aluminum soap	230	175
Calcium soap	270-290	250
Sodium soap	340-350	250
Lithium soap	390	275
Calcium complex	>500	350
Lithium complex	>500	350
Aluminum complex	>500	325
Polyurea (non-soap)	>450	350
Organoclay (non-clay)	>500	350

For long NMR has been used to study the self-diffusion of oil in lubricating greases at temperatures ranging from 23°C to 90°C. It was found out that concentration of thickeners affected the diffusion at a temperature range of 40-90°C for greases made from naphthenic and

synthetic oils [49]. Some other tests for high temperature stability are ASTM D1742, ASTM D3232 and ASTM D2595.

2.5.2 Grease thickeners

Thickeners are the substances which give consistency to the grease. Most of the greases are made up of metal-salt soaps that serve as the thickeners for the base oil used in grease formulation. Metal-salt soap thickeners are made from alkali base and fatty acids. The fatty materials could be derived from animal, marine, or vegetable fatty acids or fats. These fatty acids generally are even-numbered, straight-chain carboxylic acids which contain only one double bond. The most common base grease available in the market today is lithium 12-hydroxystearate which uses fat derived from hydrogenated castor oil upon saponification. Some of the alkali materials frequently used is lithium hydroxide, calcium hydroxide, aluminum hydroxide. Either a simple soap or a complex soap is used that is prepared from a fatty acid and a metal hydroxide. The complex grease is defined by NLGI as a soap wherein the soap crystal or fiber is formed by co-crystallization of two or more compounds: the normal soap and the complexing agent [40]. The normal soap is the metallic salt of a long-chain fatty acid similar to a regular soap thickener, for example, calcium stearate and lithium 12-hydroxy stearate.

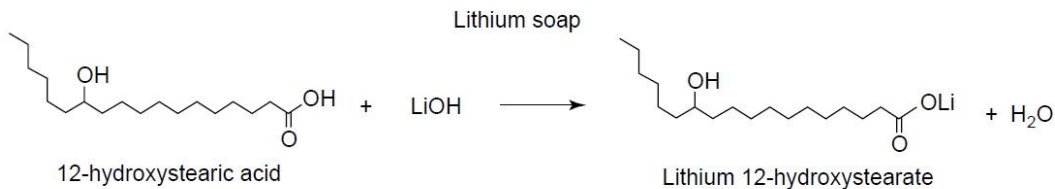

Fig 2.16 Chemical reaction for preparation of grease thickener [26]

Grease thickeners used are generally one of these types: Aluminum, Calcium, Lithium, Polyurea, Clay, Al-complex, Ca-complex and Li-complex. Complex greases can be used over a wider range of temperature as they have higher dropping points as compared to normal greases. The properties and performance characteristics of greases are directly affected by grease thickeners. Thickeners can range from soap like linear structures to circular complex

structure. Their physical dimensions can vary significantly from needles, platelets or spherical shapes.

According to a study by Boner [44] the rheological properties of lithium-based grease depend on the different fiber dimensions of the soap molecules. The fiber structure and the ratio of surface area to the volume of the fibers vary with different soaps. It has been reported in the study that the most effective shape for a thickener is a thin strip. With an increase in the ratio of surface area to volume of the thickener molecule the structure of the grease is strengthened as it is indicated by lower penetration [45]. In another study by Wilson [46] it has been reported that lithium soap fibers are in a shape of long, flat strips; Sodium soap fibers range in size from 1.5 to 100 μm & lithium soap fibers from 2 to 25 μm . Aluminum soap fibers are essentially spherical on the order of 0.1 μm .

Table 2.5 Performance features & application of greases as a function of thickeners [33]

Thickener type	Performance feature	Application
Aluminum soap	Low dropping point, excellent water resistance	Low speed bearings, wet applications
Lithium soap	High dropping point, moderate water resistance	Automotive chassis & bearings, industrial grease
Aluminum complex	Excellent water resistance, good pumpability,	Bearings, food processing industry, high temp use
Lithium complex	Resistance to softening & leakage, water resistance	Automotive bearings, high temp industrial applications

The general observation that has been observed is that greases made with different grease thickeners shouldn't be mixed in the same application which could result in bad performance due to the mixed greases as compared to their individual performances. Incompatibility and poorer performance would result in poorer performance and also might lead equipment failure. It has been observed that sodium and lithium greases are incompatible. The stability and structure of the grease thickener affects the stability of the grease when shear forces are applied. The least reduction in shear stress and film thickness in the bench tests have been shown by lithium-thickened greases; less structural resistance is also been observed

in calcium, sodium, and bentonite (clay) thickened greases [47]. The table 2.5 below summarizes the performance features & applications of greases as a function of the types of thickener [26].

Aluminum soap-thickened grease generally exhibits excellent water resistance, poor mechanical stability, excellent oxidative stability, good oil separation, poor pumpability & can be used to a maximum application temperature of 79.5°C; whereas a lithium soap-thickened grease exhibits good resistance towards water, good mechanical stability, excellent oxidative stability, moderate antirust performance depending on the formulation, fair to excellent pumpability, and in general can be used to a maximum application temperature of 275°F (135°C); Lithium complex soap-thickened grease exhibits excellent oil separation, moderate water resistance & can be used to a max application temperature of 350°F (177°C). Aluminum complex soap-thickened grease generally exhibits excellent water resistance, moderate mechanical stability, good pumpability, and in general can be used to a maximum application temperature of 350°F (177°C) [26].

Greases are similar to other lubricants wherein they exhibit a limited service lifetimes. This length of time that the grease sustains its property & performance criteria for which it was originally designed depends on the factors affecting other lubricants as well. Factors such as thermal, mechanical and oxidative stress which affect the grease structure are related to the type of thickener used. Grease may become dry and brittle as it ages and hence when used as a lubricant will not retain its lubricating properties which were the primary purpose for which it was formulated.

2.5.3 Additives

The third important component of greases is the additives which influence the physical as well as chemical properties of greases. Most of the additives would be either in a liquid form or powder form. Some of the additives included in the grease are oxidation inhibitors, anti-

friction & anti-wear additives, EP additives, rust & corrosion inhibitors, metal deactivators & tackiness additives.

The base oil present in the grease undergoes oxidation at higher operating temperatures and hence the presence of oxidation inhibitors is essential. Peroxides and hydroperoxides are produced when hydrocarbons react with oxygen at higher temperatures which further react to give the carbonyl compounds like alcohols, aldehydes, ketones, and carboxylic acids. Radical chain scission is the main mechanism behind this process. The metal soaps used in greases as thickeners catalyze the oxidation reaction. Hindered phenols and aromatic amines are the general class of antioxidants which are used, for eg: 2,6 DTBP, MoDTC, ZDDP and other Ashless additives. For low temperature applications phenolic antioxidants are the most effective however the secondary antioxidants which fall in the class of aromatic amines like PANA, PBNA (phenyl beta-naphthylamine), DPA, di-octyldiphenylamine are useful at higher temperatures [48]. When greases are formulated a combination of alkylated or secondary amine- and phenol-type antioxidants are used so as to a wider performance range from low temperature to high temperature applications. In some cases a synergy is observed when both a hindered phenolic and an aryl amine antioxidant are used in the same formulation [26].

For high performance grease EP & AW additives are a must and are used in varying proportions to reduce friction and wear that occurs onto the substrate material under moderate to more severe boundary lubrication regime. Compounds containing sulfur, phosphorus, chlorine, metals, or combinations of these compounds are known to provide good EP protection. Under extreme loading conditions where there is a contact in between asperities on the opposing surfaces, high local temperatures result in these areas enabling an EP agent to react with the worn out surface forming a surface film that helps prevent welding of the opposing surfaces [49]. Some of the most commonly used EP & AW additives are ZDDP, Fluorothiophosphates, sulfurized and phosphate compounds, thiophosphates esters. Solid

additives such as Bismuth, boron containing additives, MoS₂, fluorinated polymers, graphite and phosphate glasses are used in EP applications. The EP mechanism and properties of phosphate glasses have been studied and reported in a study by Ogawa et al [50] wherein the load carrying capability of greases has been found to be increased using the phosphate glasses which is a relatively inexpensive powder material as compared to other solid additives. It has been reported to offer wear protection under severe conditions. When light loading conditions the finely divided phosphate glass particles were reported to sustain their original round shape. It has also been suggested that the behaviour of these particles could be considered as micro ball bearings under low-loading conditions; on the other hand when the particles are exposed to high loads they get compressed and form a thick protective film on the wear surface that resists any further removal of material from the substrate.

Among the other additives that are added to the grease consist of rust & corrosion inhibitors, metal deactivators and tackiness additives. The substrate material is subjected to rusting which usually is accelerated by the presence of moisture and oxygen. It is an electrochemical reaction between the substrate material (Iron / Steel) and oxygen that is catalyzed by moisture. Due to rusting of the material, it leads to the reduction of the operational efficiencies and leads to the damage of components. Water deterring additives are added to the lubricating grease which helps in rust prevention. These additives attach to the fresh metal surface exposed as a result of wear by physical adsorption; they basically are oil soluble compounds that are highly polar in nature. Rust inhibitors form protective films that inhibit the effects of moisture and oxygen from rusting the substrate. Corrosion inhibitors function by neutralizing the corrosive acids that are formed as a result of degradation of the base oil and lubricant additives. Some of the rust & corrosion inhibitors used in greases belong to the class of carboxylic acid, fatty acids, esters, metal sulfonates, metal naphthenates & metal phenolates [51].

Metal deactivators are the materials that reduce the catalytic effect of metal on the rate of oxidation by forming an inactive or a passive film on the substrate by complexing with metallic ions. Some of the derivatives of triazoles, benzotriazoles and organic complexes containing nitrogen, sulfur and amines are found to be effective. Tackiness additives such as PIB (polyisobutylene), polybutene, ethylene-propylene copolymers and latex based compounds are included so that the grease can withstand the heavy impact that is commonly seen in heavy equipment applications. The other objective of these tackiness additives is to improve the adhesive and cohesive properties of greases that can resist the throw-off from bearings and fittings and providing the cushioning effect to reduce shock loading conditions. The additives also help in improving water resistance properties. The only disadvantage of tackiness additives is that when high degree of shear is applied they are susceptible of breaking down like any other long-chain polymers [26].

2.6 MoS₂ structure and properties

Molybdenum disulfide (MoS₂) has been used dry lubricant since several centuries [52], wherein it was often mistook for graphite for its similar appearance and its behaviour. One of the first patent for the use of MoS₂ as a solid lubricant when mixed with talc, mica, graphite and other materials appeared in 1927 [53]. In 1943 MoS₂ was first used as a lubricant in vacuum owing to its dry-film lubricant properties [54]. MoS₂ has also been used by simply rubbing it on the opposing surfaces which needs to be lubricated. It has found its use as an additive agent in greases as well as oils as well as in the form of solid compressed pellets. It has even been used as a surface coating for bearings (either hydrodynamic or hydrostatic) thereby acting as a standby lubricant if the proposed means of lubrication fails.

The lubricating properties of MoS₂ are predominantly the result of its crystal structure. In a study by Dickinson et al [55], the structure of MoS₂ has been extensively studied and reviewed; the crystal structure is known to have a hexagonal structure with six-fold symmetry, basically a layered type of a structure with two molecules per unit cell. The following figure 2.17

gives a schematic representation of the MoS₂ structure. Each sulfur atom is equidistant from three molybdenum atoms and each molybdenum atom is surrounded by six equidistant sulfur atoms at the corners of a triangular prism whose edge is 3.15±0.02 Å. The distance between molybdenum atoms and the nearest sulfur atoms is 2.41±0.02 Å. However, the vertical distance in between a molybdenum and sulfur atoms is about 1.54 Å; the vertical distance in between the two adjacent sulfur layers is 3.08 Å which is a little more than the thickness of the MoS₂ layers by themselves.

The study by Dickinson et al [55] also states that “the large distance in between the sulfur atoms is certainly linked with the outstanding basal cleavage of MoS₂. Hence, in 1923 it seemed quite obvious at that time that the low friction coefficient obtained by using MoS₂ was the result of its crystal structure; from the crystal structure it is also clear on why MoS₂ is called as a layered-lattice material. This layer lattice of MoS₂ is quite dissimilar from the crystal structure of graphite with which MoS₂ is often compared. Although there are strong covalent bonds in between Mo and S atoms the layers where in only S-S atoms interact have weak Van der Waals type; it is along this plane of weak bonding that the shearing of the layers takes place thereby leading to a low friction and weld load index.

2.6.1 Mechanism of friction of MoS₂

MoS₂ has been known for its low coefficient of friction; however there have been a number of theories proposed to explain the reason for this type of behavior. To understand the frictional behavior of MoS₂ it is very crucial to have an understanding of the S-Mo-S bonding and the angles in between them [56,57]. Considering the interplanar electron bonding, the similarity in between graphite and MoS₂ is over-emphasized [58]; however this bonding is stronger in graphite as compared to the S-S bonding in MoS₂ [59]. The polarity on the surface of MoS₂ allows adsorption on the face that is cleaved; it would permit the adhesion of MoS₂ layers onto the surface of metals and metal oxides [60].

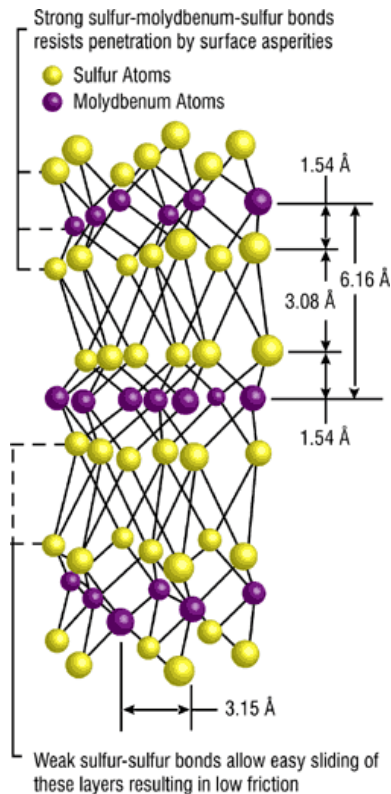

Fig 2.17 Crystal structure of MoS₂ particles [61]

There have been three major theories suggested to understand the mechanism of friction in MoS₂ and two of these theories explain the mechanism basing it on the behavior of graphite. The three theories used to describe the friction mechanism of MoS₂ are: a) Intrinsic cleavage mechanism, b) Adsorption mechanism theory and c) Inter-crystallite slip mechanism [58].

Intrinsic cleavage mechanism was first suggested in 1923 by Dickinson et al. [55] when they suggested that the crystal was made up of lamina which consisted of a single Mo & two S atoms with Mo separating the S atoms. The distance in between the sulfur atom of one lamina and the sulfur atom present in the adjacent lamina was greater than the thickness of the lamina itself. This inter-laminar distance being larger than expected by the theory of atomic packing which takes into consideration the atomic radii led them to conclude that the large distance was

connected with the excellent basal cleavage of MoS₂ and hence the low friction characteristics were intrinsic to the crystal structure.

Adsorption mechanism theory suggests that the low frictional behavior of MoS₂ was a result of foreign material that was adsorbed on the MoS₂ crystal surface which weakens the structure. This mechanism was first proposed by Finch et al. [62]; however two studies in 1952 and 1954 by Feng et al [63] and Savage et al [64] reported that the low friction behavior of MoS₂ was independent of adsorbed films. The adsorption theory suggests that the friction of MoS₂ should increase at a higher vacuum wherein the contaminant layer would be desorbed. However it was found out that the coefficient of friction actually decreased as the level of vacuum was increased. It was concluded less the contamination of MoS₂, lower the coefficient of friction; leading to a conclusion that frictional characteristics might be intrinsic to the material as suggested by Dickinson et al [55].

Inter-crystallite slip mechanism suggests that stable oxides are formed when high energy edge surfaces of the crystallite rapidly react; these oxides are meant to have weak attraction for surfaces with low cleavage energy and other edge surfaces which results in a weak inter-crystallite adhesion and low friction. This theory was proposed in 1958 by Deacon et al [60] and Braithwaite et al [65]. The behavior of graphite was used as the basis to propose this theory. The main drawback of this theory is that it fails to explain the effect of crystal orientation on variation of coefficient of friction. It is also known that when the basal plane is parallel to the sliding surfaces the coefficient of friction is the least; and is the highest when the basal plane is perpendicular to the sliding surface [36]; however a result contrary to this finding would be expected from the above theory.

In a study by Barry et al [66], it was suggested that addition of MoS₂ to grease that didn't contain any antioxidants would improve its oxidation stability, however the performance of greases which contain a combination of additives might be adversely affected upon indiscriminate addition of MoS₂. Addition of MoS₂ also helps improve the lubricant performance

of Lithium hydroxystearate base greases under high load and frequency conditions. It has also been noted that for high performance MoS₂ grease, concentrations higher than 3 wt. % are needed. In a review paper by Winer et al [58], it has been stated that the presence of water vapor has a significant effect on the lubricating properties of MoS₂ based greases. The absence of water vapor essentially reduces the coefficient of friction of MoS₂ film.

2.6.2 Effect of various parameters on MoS₂ when used as a lubricant

The effect of humidity or the presence of moisture in the environment is known to have an effect on the lubricating tendency of MoS₂; it has been reported that the friction of MoS₂ decreases when the condensable vapors are removed from the atmosphere. Water vapor in particular has a significant effect on the functioning of MoS₂ as a lubricant. In one of the studies on effect of relative humidity on the friction behavior by Peterson et al [67], it has been reported that the friction between interacting metal surfaces lubricated by MoS₂ increased up to 65% R.H. & then slowly decreased. In another study of the effect of humidity, temperature and interacting time on natural MoS₂ powder by Midgley et al [68], it has been reported that for natural MoS₂ the frictional resistance is largely controlled by the amount of moisture content in the film. It has been shown that the friction decreases when there is an increase in the temperature & a decrease in the relative humidity as well as with the interacting time in an environment with a fixed relative humidity. The absence of condensable water vapor leads to a reduction of coefficient of friction. In another study by Haltner et al [67], it has been shown that the presence of water vapor in a nitrogen atmosphere lead to an increase in the coefficient of friction of MoS₂ which was in the form of compressed pellets and these were rubbed against the opposing surface leading to a transfer film on the metal surface. When the atmosphere was changed to dry nitrogen it resulted in a sudden drop of the coefficient of friction.

The coefficient of friction of MoS₂ also depends on the loading conditions that exist. In a study by Salomon et al [68], the effect of load & rpm or the sliding speed on the life of rubbed un-bonded films of MoS₂ is being presented, the investigations reveal that the wear life of the

component was not hugely affected by low loads and high speeds, however at high loads and low speeds there was a high amount of wear of the component. In another study by Boyd et al [69], they reported that the friction coefficient of MoS₂ decreased with increasing the load upto a pressure of 40,000 atm in an opposing anvil type device. The friction coefficient at this pressure was about 0.032. In a study by Johnson et al [70], it was shown that the change in the coefficient of friction of MoS₂ films slightly increased with loads at lower loads and then remained constant with continually increasing load. It was even suggested by Midgley et al [68], that the effect of load on the coefficient of friction was related to the moisture content of the film.

The particle size of MoS₂ also has an effect on the wear life of the component as well as the surface finish of the substrate. In a study on the effect of particle size and load bearing capacity of grease & its oxidation stability by Devine et al [71], they reported that for particles of sizes 0.7 µm and 7 µm, there was no significant change in the load bearing capacity, however when the particles of size 0.3 µm were used, the load bearing capability was significantly reduced; when tested for oxidation stability, the greases containing MoS₂ particle sizes of 0.3 µm and 0.7 µm, the oxidation resistance had reduced as compared to the base grease. In another study by Vineall et al [72], it has been shown that the oxidation resistance of the MoS₂ containing oils & greases reduces with increase in reduction in the size of the MoS₂ particles and that excessive micronization should be evaded particularly if it's to be used in a moist or damp environment.

Table 2.6 MoS₂ particle size and properties [73]

MoS ₂ grade	Fisher number (µm)	Particle size by SEM (µm)
Technical	3 to 4	<1 to 100
Technical fine	0.65 to 0.8	<0.5 to 20
Superfine	0.4 to 0.45	<0.5 to 8

Other factors that affect the friction of MoS₂ are temperature, vacuum environment, and radiation environment, the type of substrate used, the presence of impurities and MoO₃ and the effect of crystallographic orientation [58]. The typical size of particles of MoS₂ is given in the table 2.6.

2.7 ZDDP, PTFE & MoDTC

ZDDP & PTFE have been extensively used as anti-friction and anti-wear additives that generally yield a low friction coefficient and low wear numbers. In the recent studies they have used in oils as well as greases [74,75], the third grease blend used in the study consisted of 3 wt. % ZDDP and 2 wt. % PTFE. The ZDDP used was supplied by Chevron Oronite and had a commercial name OLOA 262 [76]; the functionalized PTFE used was supplied by DuPont chemicals and had a commercial name of Zonyl MP-1150 [77].

2.7.1 ZDDP

Zinc Dialkyldithiophosphate (ZDDP) has been in use as a major AW additive for more than 50 years in the lubrication industry. Apart from its low cost of production it is used as a multifunctional additive in engine and gear oils, transmission and greases as well. Apart from being an excellent AW additive it is used as an effective anti-oxidant, corrosion inhibitor and a mild EP additive. These are the main reasons it is still being manufactured by corporations like ExxonMobil, Chevron, Lubrizol and others.

ZDDP was first produced by Union Oil of California in 1944 [78]. The original route to manufacture ZDDP is as shown in the figure 2.18. Occasionally this route is used today; however due to the production of H₂S as a by-product which is toxic and also the usage of P₂S₅ during the production of ZDDP is a flammable solid, this route is generally discouraged and not often used. P₂S₅ is produced by the reaction in between elemental P and elemental S.

ZDDP is an organometallic compound which has four sulfur atoms that have been coordinated with the zinc atom; this is a sp³ hybridized state. On analysis of raman spectrum for ZDDP, it shows a presence of a strong P–S stretching band near 540 cm⁻¹ that is symmetric

and an absence of a strong Raman band near 660 cm^{-1} ; this indicates a presence of a sulfur-zinc coordination arrangement that is symmetrical.

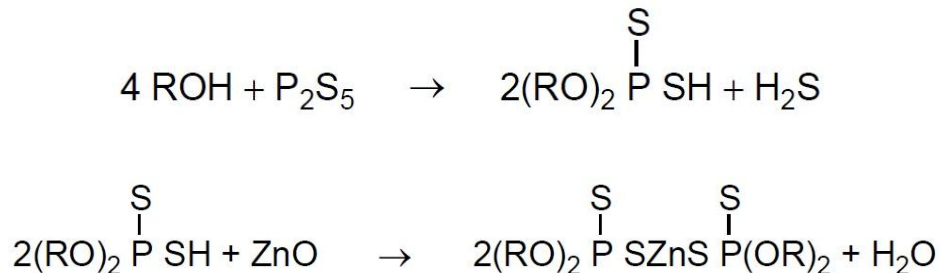

Fig 2.18 Original route used to manufacture ZDDP [26]

A neutral ZDDP molecular structure is shown in the figure 2.19. The neutral ZDDP molecule may exist as a monomer, dimer, trimer or an oligomer depending on the state of the ZDDP, whether its crystalline or in liquid state, the concentration of ZDDP in solvent, and the presence of additional compounds [79].

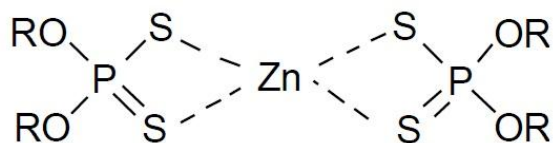

Fig 2.19 Neutral ZDDP molecule [26]

ZDDP molecules which have alkyl groups containing four carbons or less are solid at room temperatures and have a general tendency to have limited or no solubility in petroleum base stocks; on the other hand ZDDP molecules containing aryl or alkyl groups with more than five carbon atoms are liquids at room temperature. It's important to study and understand the thermal degradation of ZDDP as some of the tribological characteristics of ZDDP can be explained by the effects of the decomposition products. In some of the past studies, it has been noted that the thermal decomposition of ZDDP in mineral oil has been found out to be extremely complex as it will give off volatile compounds such as olefin, alkyl disulfide etc. It is also well-known that a white precipitate will form, which has been determined to be a low sulfur-

containing zinc pyrophosphate compound. The decomposition products of ZDDPs generally consist of secondary alkyl alcohols, straight-chain primary alkyl alcohols, branched primary alkyl alcohols in different proportions [80].

ZDDP is generally used as an antiwear additive, however it is known to exhibit mild EP characteristics. ZDDP is effective under mixed lubrication regime whereon a thin film of oil separates the interacting metal surfaces; however when the asperities contact each other there is a metal-on metal contact, at these points the ZDDP reacts with these asperities forming tribofilms which are sacrificial tribofilms reducing the contact. When operating under boundary lubrication regime wherein the surface asperities make frequent contact, the ZDDP reacts with the entire metal surface to prevent welding or seizure and leading to a reduction in wear. There have been numerous studies wherein it is shown that the thermal degradation products of the ZDDP act as antiwear agents. The thickness of the tribofilm is directly dependent on the type of the additive, its degradation products and the extent of the surface rubbing. In the beginning of the test, ZDDP is reversibly absorbed onto the metal surface at low temperatures; however when there is an increase in the temperature there is catalytic decomposition of ZDDP to dialkyldithiophosphoryl disulfide occurs, with the disulfide absorbed onto the metal surface [81]. In a study by Kim et al [82], the AW/EP film formed from ZDDP it has been said to be composed of various layers of ZDDP degradation products. Some of the degradation products react with the surface forming what is known as chemisorption tribofilms. The layer composition is dependent on the temperature. The sulfur present in the degradation products first reacts with the fresh exposed metal surface leading to the formation of a thin iron sulfide layer [83], the next step in film formation is that phosphates react to produce amorphous layers of short-chain ortho and metaphosphates with small quantities of sulfur compounds in it. It has also been shown that the phosphate chains become longer near the surface, with the least chain length of approximately 20 phosphate units [84]. This regions has been very famously called as the “phosphate-glass” region in which zinc and iron cations in the film stabilize the glass structure;

the outermost region of the tribofilm where there is a presence of phosphate chains, it is found that it contains a significant number of organic ligands and un-degraded ZDDP. The studies that have analyzed the thickness of the film report them ranging from as small as 20 nm to as large as 1 μm [85].

ZDDP is extensively used in engine oils as an effective antiwear additive & as an antioxidant. Secondary ZDDP performs better as compared to primary ZDDP in the EP applications which are quiet common in scenario like valve train or heavily loaded contacts. A combination of detergents as well as dispersant's is used as well in the oils along with viscosity improvers, rust and corrosion inhibitors. For a typical lubricant additive package used in engine oils, the treat levels can run as high as 25%. According to ILSAC, GF-3 engine oil is supposed to include a maximum limit of 0.1% phosphorus to reduce the engine oil's adverse effect on the emissions catalyst; for the GF-4 engine oil specification, the Phosphorous limit was reduced further. Due to these specifications the treat level for ZDDP in oils is now limited to about 0.5 to 1.5 % depending upon the alkyl chain length. A study by Yamaguchi et al [86], has shown that the antioxidant properties of ZDDP is significantly enhanced when used with group II base stocks with as much as 50% increase noted for a basic or neutral ZDDP. In many of the industrial research, the synergy in between organic molybdenum compounds and ZDDP in reduction of wear is being studied as a means of lowering the P content in engine oils. In some of the patent literatures MoDTC (Mo-dithiocarbamates) and MoDTP (Mo-dialkyldithiophosphates) are being cited as synergistic with ZDDP in its AW properties [87]. ZDDP has also been used in hydraulic fluids as AW agents and as effective antioxidants with a treat level of 0.5 wt. %. In this application primary ZDDP are preferred over secondary the ZDDP because of their superior properties of thermal and hydrolytic stability.

ZDDP have been used in greases since a long time as boundary lubrication and elasto-hydrodynamic lubrication regime are common places where grease is used. ZDDP treat levels are in the same range as compared to the motor oils. Secondary ZDDP or a combination of

primary & secondary along with other additives is used. Secondary ZDDP is preferred over the primary ZDDP because of its thermal instability resulting in quick film formation under high loads. In motor oils ZDDP is used as an EP agent with a treat level of 1.5 to 4 wt. %.

2.7.2 PTFE

Polytetrafluoroethylene (PTFE) has been in use as a very effective friction modifier in the lubricant industry from as early as 1940. Structurally, the polymer is made up of repeating chain of substituted ethylene with four fluorine atoms on each ethylene unit which is represented by: $-(CF_2-CF_2)_n-$

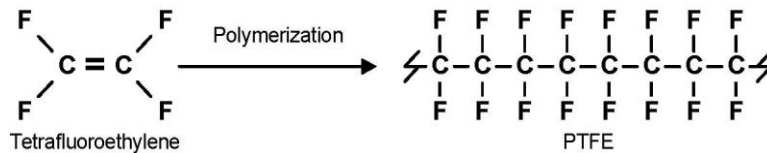

Fig 2.20 Picture showing the polymerization of TFE monomer to form PTFE [88]

Figure 2.20 depicts the polymerization of a tetrafluoroethylene monomer to form PTFE. When compared to the structure of other solid lubricants, PTFE does not have a layered lattice structure; the high softening point of PTFE is one of the reasons for the lubricious properties of PTFE. When there is a contact in between asperities, there is generation of heat, the PTFE particles maintain their durability and is able to lubricate the interacting surfaces leading to a reduction in friction. It has also been well known that the molecular weight and the particle size of the PTFE are two main characteristics that affect the lubricating properties of the PTFE. The low COF (coefficient of friction) has been well-known of PTFE has been well known and its values are as low as 0.04 to 0.1 for sliding conditions when used alone as a solid lubricant in between the interacting surfaces [89]. The property of low COF of PTFE is attributed to its smooth molecular profile of polymer chains which can orient in any manner possible that can facilitate sliding and slipping. It has also been reported that when the TFE monomer polymerizes to form PTFE, it takes up a rod-shape that can easily slip along each other [90],

which is a similar behaviour as compared to any other solid lubricant that has a lamellar structure.

Table 2.7 Physical properties of PTFE [26]

Property	Value
Coefficient of Friction-ASTM D1894	0.04-0.1
Dielectric constant	2.1-2.4
Hardness	50-60 Shore D
Melting point	327°C
Service temperature	Upto 260°C
Specific gravity	2.15-2.20

Due to the chemical inertness of PTFE, it is very attractive as it can be used from a wide range of temperatures ranging from cryogenic to high operating temperatures and also in a variety of environments. However it can be used upto a temperature of 260°C as the polymer decomposes above this temperature. At very high loads the pressure acting over the particle results in the destruction of the polymer particles and leads to cold weld at the asperities junction leading to the lubrication failure; the PTFE coagulates and fails to remain intact on the rubbing surface. PTFE is widely used as an additive meant for friction reduction in greases and oils. It has also been know that the nature& the type of feedstock of the PTFE do influence the ability to create a stable, un-flocculated dispersion, which is necessary for effective lubrication in crank case oil and hydraulic fluids.

PTFE can be used as a solid lubricant as well as along with lubricating oils and greases. Some of the conditions where solid lubrication is preferred over the conventional medium are: high operating temperatures, contact pressures of sufficient magnitude which break the integrity of a liquid lubricating film, applications that undergo frequent start-stop and applications where low sliding speeds & high loads are present. For a fool-proofing system, a

secondary lubricant which is basically a solid lubricant is incorporated in a liquid phase primary lubricant, this is particularly helpful if the liquid film breaks owing to high contact pressures or if the additives get depleted after using the lubricant for a long time without any replenishment or replacement of the used lubricant.

2.7.3 *MoDTC*

MoDTC (Molybdenum Dithiocarbamate) is a commonly used additive for lubricants as friction modifiers (FM). Analogous to the AW additives, wherein the sacrificial protective layers are formed by either chemisorption or physisorption of the additive or the degradation products with the metal surface, the principal behind the FM's is similar, however, the main difference is that the reaction has to occur under moderate conditions of temperature & load in the Mixed Lubrication regime. These necessities a relatively high level of chemical activity as demonstrated by the phosphorus & sulfur chemistry. Due to the polar head of the molecules they are adsorbed to the metal substrate while the hydrocarbon tail is left solubilized in the oil which in most cases is perpendicular to the surface. It has also been suggested that the polar heads are attracted by the presence of hydrogen bonds resulting in dimer clusters. The presence of Van der Waals forces causes the molecules to align these FM molecules [91]. All of these conditions result in multi-molecular layer that is difficult to compress, however very easy to shear at the hydrocarbon tail interfaces, thereby giving an explanation on the friction reducing properties of FM's; the sheared-off layers are easily rebuilt to their original state. Figure 2.21 below describes the multilayer structure of the FM molecules. The thickness and effectiveness of polar groups depends on parameters like polar group, chain length, molecular configuration and temperature. The two categories of FM are Metallo-organic compounds and Oil insoluble materials.

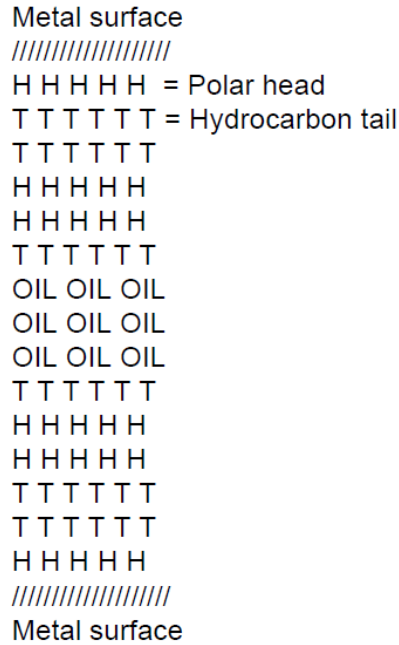

Fig 2.21 Multiple layers of FM molecules on the metal substrate [26]

Additive compounds like dithiophosphates, dithiocarbamates, dithiolates and oleates fall in the category of Metallo-organic compounds and the compounds such as PTFE, talc, graphite and MoS₂ fall in the category of oil insoluble materials.

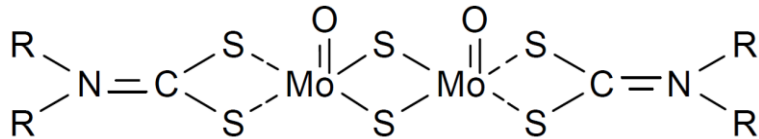

Fig 2.22 A structural drawing of Molybdenum Dithiocarbamate [26]

Figure 2.22 above shows a schematic illustration of the MoDTC molecule. The Organomolybdenum compounds (OMC) have received a significant attention in the recent years in their applications as FM's, AW and AOx additives [92,93], however owing to their low solubility in the base oils has prevented them from using in many commercial applications [94]. Some of the recent studies [95] have shown that this problem of insolubility can be overcome by combining these compounds with an AW or an EP additive that is readily soluble in oils [96].

The MoDTP is known to possess better AW characteristics as compared to MoDTC. However, the AW aspects of MoDTC could be improved when they are combined with ZDDP. The main reason for this effect is thought to be due to interaction of Zn from ZDDP with the electron donating nitrogen of MoDTC, which catalyzes its tribo-reactivity; however this effect doesn't exist in the case of MoDTP. The enhanced AW properties that are seen from the combination of MoDTC & ZDDP are attributed to the formation of MoS₂ on the wear surface. It is also suggested that the formation of metal sulphides and metal phosphides on the wear surface helps in prevention of wear and friction of the surface [97].

2.8 Tribofilm

A tribofilm can be defined as a protective sacrificial layer that is created when there is a contact in between the asperities on two interacting surfaces in presence of a lubricating medium [98]. These tribofilms that are generated are continuously sacrificed and replenished as far as the film forming AW & EP additives are present in the lubricating medium. The tribofilm itself is sacrificed thereby protecting the metal substrate from further wear & tear. Tribofilms are generally formed in boundary lubrication regime and in mixed lubrication regime where there is a higher chance of asperity contact as the thickness of the lubricating medium is very less.

Tribofilms can be formed either by chemisorption or physisorption; the films that are formed by tribochemical reactions due to the activation of additive chemistries at the points or areas of asperity contact under the influence of temperature, pressure & rpm are known as chemically-adsorbed tribofilms. On the other hand the films that are formed by physical deposition of lubricant particle which is either known to have a lamellar structure or if it adsorbs itself at the points of asperity contact thereby protecting it from further wear [99]. The tribofilms that are formed are known to reduce the frictional resistance in between the interacting surfaces and also increases the wear resistance [100]. In a study by Biswas et al., it was reported that the tribofilms could be formed by mechanical mixing, tribochemical interactions or thermal activation [101].

The synthesis of more efficient additive to be used in lubricants is based on the study of tribofilms formed on the interacting surfaces in a lubricating medium. The thickness and composition of the tribofilms formed by chemisorption depends on the type of the additive used and its concentration or the treat level. Other parameters like the applied load and temperature are also known to have an effect on the tribofilms [102,103]. The environmental factors such as humidity or the moisture content and other test variables like the rpm or the speed of the interacting surfaces & the duration of the test also influence the formation of the tribofilm [104]. In a study by Graham et al. the thickness of the tribofilm is a known to be an important factor to gauge the anti-wear performance of the film, as the film acts as a protective sacrificial layer in between the two interacting surfaces by reducing the asperity contact [105]. The patchy tribofilms which promote anti-wear properties are those which form during sliding process of the interacting surfaces; these regions act as load bearing areas leading to a reduction in the metal to metal contact and thus decreasing plowing, abrasive and adhesive wear.

During the process of frictional sliding, the tribofilm ruptures locally due to sliding & contact of micro asperities & is continuously replenished as far as the additive present are capable of forming tribochemical reaction products. The rate of the tribochemical reactions by the additive chemistry present is higher at elevated temperatures that results in the interface of the interacting surfaces thus resulting in faster tribofilm formation & replenishment. A recent study by Komvopoulos et.al [106] has reported that tribofilms maintain their integrity even under relatively low sliding conditions wherein lower rates of tribochemical reactions exist; it may retard tribofilm replenishment resulting in increased wear of the surface. The properties of the tribofilm formed on the wear surface depend on parameters like chemisorption, decomposition & the chemical interactions between the most reactive decomposition products that are formed by chemical degradation of the additive chemistries in the lubricant and the sliding interfaces. The tribochemical reactions in a given tribological system strongly depend on the conditions like

relative velocity in between surfaces, contact pressure, the time or the total duration of sliding and the temperature [107].

In a study by B Kim et al [82], it has been demonstrated that the anti-wear properties, thickness and hardness of the tribofilm are directly related to the additive chemistries present in the lubricant. The figure 2.23 shows a schematic representation of the tribofilm formed on a steel substrate using a HFRR (High Frequency Reciprocating Rig) and two different additive chemistries namely ZDDP and fZDDP. The chemistry fZDDP which stands for fluorinated ZDDP being the proprietary of UTA and is produced by reacting ZDDP with fluorinated transition metals compounds like MF_x where M is Fe, Ti, Zr or Al; fZDDP forms stronger bonds as compared to ZDDP with the substrate and its reaction products combine with the tribofilm as well resulting in a more thicker and stable tribofilm which has superior AW properties as compared to the tribofilm formed using the conventional ZDDP. The thickness of the tribofilm for ZDDP & fZDDP as reported in the study was around 100nm and 180nm respectively. The thicker tribofilm formed by fZDDP compounds was capable of handling higher contact loads.

Compounds such as sulfides, phosphates, borates and other metal oxides form inorganic tribofilms whose compositions depend upon the additives used in the lubricant to generate them. The tribofilms formed from P and B containing compounds have resistivities similar to those of oxides whereas tribofilms containing sulfides may behave as semiconductors and do possess lower resistivities [108]. It's always beneficial to have tribofilms that have a higher quantity of sulfide compounds as they produce lower friction whereas tribofilms containing borate and phosphate dominated compounds are effective in increasing the wear resistance of steel substrate. Sulfur containing additive like sulfurized olefins do perform better as friction modifiers rather than AW additives.

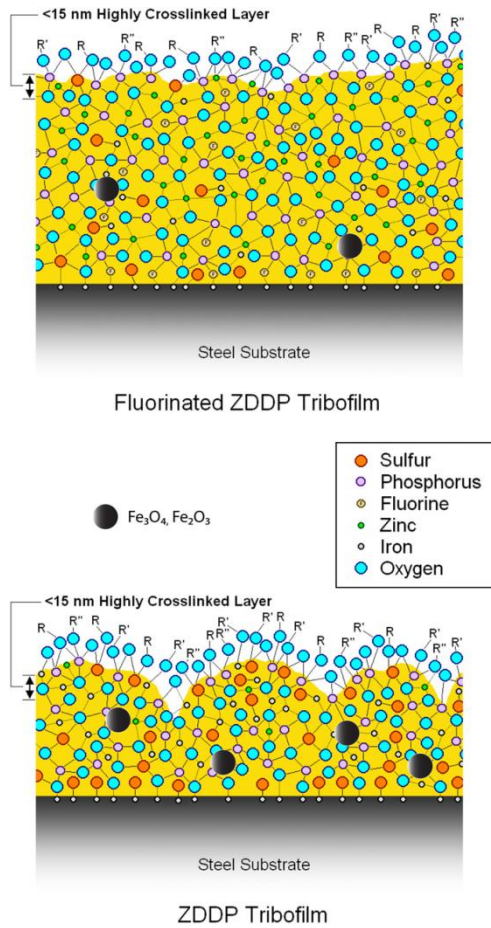

Fig 2.23 Tribofilm formed from different additive chemistries [82]

Another type of film called as a Transfer film is obtained due to tribochemical reactions in between a tribofilm, native oxide film formed on the substrate and nascent metal surfaces that are produced when there is material removal due to wear. In a study by Pearson [109], the chemistry of transfer films is demonstrated by modeling using the principle of hard and soft acids and bases which is abbreviated as HSAB. The transfer film is produced when there is a transfer of reaction products from additives onto the opposite interacting surface from the sliding surface tribochemically. These transfer films play an important role in modifying the friction behavior of a tribological system.

Under boundary lubrication regimes when very high loads or low speeds exist, the lubricant film in between the sliding surfaces can no longer be maintained & one can expect direct contact between the asperities to be more evident. When fresh surface is exposed due to wear, the tribochemical reaction products that are formed due to degradation of additive chemistries present bond to the nascent surface forming a sacrificial protective surface film that prevents further wear and enhances the load carrying capabilities; this film is known as a Tribofilm. The repulsive forces between the films are responsible for carrying a significant part of the load and also shield the asperities from coming in contact with each other. When the additives decompose under boundary lubrication regime the polar end groups of long chain carboxylic acid form a strong bond with the metal surface; it has also been found out that the long chains can orient themselves to form protective layers. Depending upon the chain length of the carboxylic acid, the friction coefficient is affected.

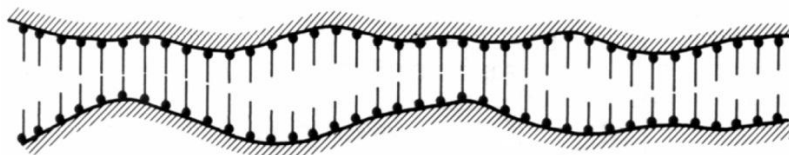

Fig 2.24 Simplified view of Boundary lubrication [110]

The figure 2.24 shows a schematic representation of the boundary lubrication regime showing the tribofilm formation and the polar end groups. The polar end groups present in the additive chemistry upon degradation under high temperature and load form bonds with the two interacting surfaces as shown in the figure and the carboxylic acid chains form the thickness of the tribofilm imparting it AW & EP properties. Although it has been established that even monolayers of tribofilm exist, in most of the cases multilayers of tribofilm are formed which give better wear protection as compared to the monolayer films.

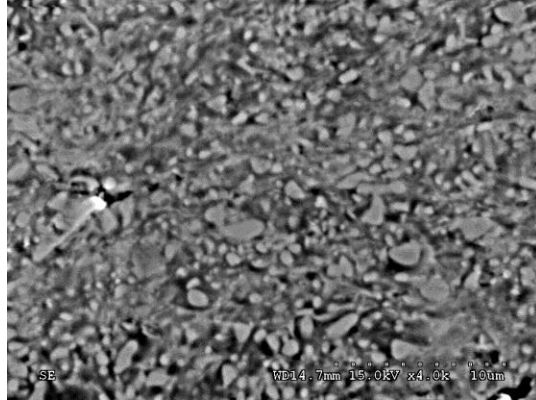

Fig 2.25 Patchy tribofilm formed from Ashless thiophosphates [111]

Figure 2.25 shows a high magnification SEM (Scanning Electron Microscope) image of a lubricious and a patchy tribofilm formed from HFRR in the presence of a lubricant medium containing Ashless thiophosphates additives. The bright-white colored patches that are visible are the regions wherein high contact loads and maximum wear was encountered. The additive molecules form a chemically adsorbed tribofilm that protects the wear surface from further wear & tear.

Another class of additives is those which protect the surface under EP conditions; these molecules only react when the extreme conditions of pressure and temperatures are reached wherein they react with the nascent surface, producing thereby producing a protective layer with low shear strength in the exact area wherein these conditions exist. The EP additives consist of sulfur, phosphorus & chlorine which form sulfides, phosphates, or chlorides on the wear surface. Other additives that are frequently used include ZDDP (zinc Dialkyldithiophosphate) which is also abbreviated as ZnDTP, TCP (tricesyl phosphate) and dibenzyl disulfide [110].

CHAPTER 3

EXPERIMENTAL APPROACH AND MATERIALS USED

The aim of the current research work was to develop high performance greases and to evaluate their AW (anti-wear) properties under spectrum loading conditions. In real life applications the parameters such as load, rpm and the temperature do vary and it is very important to test the greases in these conditions and understand their behavior rather than just testing it under ASTM standards (ASTM D2266) which specifies fixed conditions for load, rpm and temperature. In the current study four different blends of greases were used and tested under spectrum loading conditions. This chapter reviews the different additives used for formulating greases and also discusses the procedure and test protocols for all the tests carried out thereby providing an outline to the research methodology followed in this work. An effort is also being made to understand the mechanism of formation of tribofilms and its AW properties.

This chapter discusses the properties of the additives used and their advantages as well as disadvantages. This chapter discusses the six different test conditions that were carried out for all the grease blends; it also gives an in-depth analysis of the different waveforms for load and rpm that were used in the research work. A brief procedure that was followed to determine the WSD (Wear Scar Diameter) for the steel balls used in the study is also discussed. Different characterization techniques like SEM (Scanning Electron Microscopy), EDS (Energy Dispersive Spectroscopy), Stereo-optical microscope which were used to analyze the wear mechanism, tribofilms and the wear surface are discussed as well.

3.1 Additive chemistries and Formulation of greases

3.1.1 Base grease

The base grease used in the study was supplied by Texaco under the brand name Texaco Marfak[®] Multipurpose 2 grease. This grease is manufactured using highly refined base

oils which have a medium viscosity index. It is lithium base grease as it consists of lithium 12-hydroxystearate thickener along with rust & oxidation inhibitors. It is also known to resist separation or throw out from the bearings and is work stable. It is pumpable at low temperatures.

Table 3.1 Typical test data for Texaco Marfak[®] Multipurpose grease [112]

NLGI Grade	2
Product Number	220958
MSDS Number	8962
Operating Temperature °C (°F) Minimum Maximum	-20 (-29) 121 (250)
Penetration at 25°C Worked Worked (10000X), % Change	280 5
Dropping Point °C (°F)	188 (370)
Copper Corrosion	1B
Thickener (Type & % used)	Lithium & 7.5%
Kinematic viscosity at 40°C (cSt)	220
Flash Point °C (°F)	198 (388)
Pour Point °C (°F)	-12 (+10)
Texture	Buttery
Color	Brown

Texaco Marfak[®] Multipurpose grease is generally used for automotive and industrial applications wherein the EP conditions don't exist. Below is a table of properties of the base grease obtained from the manufacturer.

3.1.2 Additive chemistries & blending of greases

A total of four grease blends were prepared in batches of approximately 200 grams each. The Lithium-base grease used was Texaco Marfak[®] Multipurpose grease. The additive

chemistries were carefully chosen which could impart the AW properties to the grease as well enhance the EP properties as well. MoS₂ has long been used as an EP additive as well as a solid lubricant due to its lamellar structure [58]. However due to the presence of the sharp edges and corners on these particles it also acts as a pro-abrasive agent under load loads wherein the lamella are not sheared under the load on the interacting surfaces. One of the main goals of this research is to search for a replacement of MoS₂ altogether or to get rid of the sharp edges or corners present by treating the MoS₂ particles.

The first type of grease was blended using Unmilled MoS₂ (or Techfine MoS₂) as this is a commonly used grease blend for EP conditions in industrial applications. The second type of grease was blended using the Milled MoS₂ (or treated MoS₂). The techfine MoS₂ is take milled in a ball-milling machine; this helps in getting rid of the sharp corners and edges thereby reducing its abrasiveness while maintaining its EP properties. The third type of grease used was a combination of PTFE & ZDDP which was proven to have good EP and Aw properties in a previous study by Suresh et al [2]. The forth grease is a modified grease 3 wherein a friction modifier (molybdenum dithiocarbamate (MoDTC)) was added. Table 3.2 below gives an overview of the grease formulations and the type of additives and their respective treat levels.

Table 3.2 an overview of grease formulations and additives used

Sl. No	Type of base grease	Additive used	Weight % of additive
Blend 1	Lithium 12 hydroxystearate (NLGI grade 2)	Techfine MoS ₂ (Unmilled MoS ₂)	3 wt.%
Blend 2	Lithium 12 hydroxystearate (NLGI grade 2)	Ballmilled MoS ₂ (Milled MoS ₂)	3 wt.%
Blend 3	Lithium 12 hydroxystearate (NLGI grade 2)	ZDDP and PTFE	ZDDP (3 wt. %) PTFE (2 wt. %)
Blend 4	Lithium 12 hydroxystearate (NLGI grade 2)	ZDDP, PTFE and MoDTC	ZDDP (3 wt. %) PTFE (2 wt. %) MoDTC (2 wt. %)

A kitchen aid mixer was used for blending of the greases. Its electrical specifications were 120 volts, a power rating of 250 W, 60 Hz frequency and 1 gallon of blending capacity.

The speed of the mixer used for blending was about 100 rpm. It had a stainless steel bowl and was cleaned with hexane before using it every time for blending. Each grease formulation was blended for 2 hours and every 15-20 minutes the grease that was sticking to the sides of the steel bowl was scraped using a spatula and then the blending was continued again. Figure 3.1 shows the kitchen aid mixer that was used for all the blending purposes [113]. A planetary ball-mill of a smaller scale was used for milling of MoS₂ particles which were used in the second grease blend. It is manufactured by Van Ho and has arrangements for milling two different materials at the same time.



Fig 3.1 Kitchen aid mixer used for blending of greases in the TLCL lab at UTA

The machine in the TLCL lab had a fixed speed of about 200 rpm. The electrical specifications for the machine were 1/4 HP motor, 110 volts and 60 Hz supply [114]. MoS₂ particles which were available off the shelf was taken in a HDPE bottle and was subjected to ball milling using zirconia balls for a period of 48 hours. About 40 wt. % of zirconia balls of varying sizes were used for the milling operation.

The SEM images of the milled MoS₂ does suggest that after milling the particles for 48 hours the sharp edges and corners are removed which helps in reduction of the wear numbers after the four ball tests were run on greases formulated using milled MoS₂. Figure 3.2 below shows a commercial ball mill in the TLCL lab at UTA which was used for milling operations.



Fig 3.2 Commercial ball-mill used for the milling process

The following methodology describes an in-depth procedure that was followed during the blending of greases. A total of four greases were blended.

1. The first grease blend was prepared using techfine or unmilled MoS_2 that was available off the shelf; it was supplied by Climax Molybdenum (Phoenix, AZ). A total of 3 wt. % MoS_2 was used in the base grease. In a previous study done by Suresh et al [2], it was demonstrated that there was an improvement in the EP properties when MoS_2 was added upto 3wt. %, however when 5 wt. % was used it lead to an increase in the wear numbers which was detrimental. The average particle size of techfine grade MoS_2 was in a range of 5-20 μm according to the supplier as well as approximate measurement of the particle sizes from SEM images which had a micron marker scale on it. The mixture was blended using a kitchen aid mixer for about 2 hours. Every 15-20 min the grease that was sticking to the sides of steel bowl was scraped and collected back at the bottom of the bowl and then the mixing was continued.
2. The second grease blend was prepared using ball-milled MoS_2 . It has being proven by a number of literatures [58,115] as well as the previous studies that the features similar to the sharp edges or corners on the unmilled or techfine MoS_2 was responsible for the abrasiveness as well as an increase in the wear numbers. It was hypothesized that getting rid of these sharp edges or corners might be beneficial

from the wear point of view while keeping the EP properties intact. The simplest way to achieve this was by using a ball-mill; techfine MoS₂ was taken and mixed with an industrial solvent like hexane in 1:1 ratio by weight. This mixture was taken in a 250 ml HDPE bottle. To this mixture 40 wt. % of zirconia balls of varying sizes (0.625 mm to 12.5 mm) was added. This entire mixture was then subjected to milling in a planetary ball-mill continuously for about 48 hours. Upon milling the contents from the bottle was filtered through a steel mesh so as to separate the zirconia balls. After separation the filtrate consisting of hexane and milled MoS₂ was kept in a chemical fume hood at room temperature for about 24 hours so as to extract hexane out of it. Hexane was added as it served as a dispersant medium which made sure that particle agglomeration didn't occur post the milling process. The ball-milled MoS₂ was then added to Li-base grease and mixed using a kitchen aid blender for about 2 hours. 3 wt. % of the milled MoS₂ was taken so that a direct co-relation could be established in between the properties obtained from the first as well as the second grease that contained unmilled and milled MoS₂ respectively.

3. The third grease blend was prepared using a mixture of functionalized PTFE (Poly tetrafluorethylene) and ZDDP (Zinc dialkyl dithiophosphate). In general PTFE is a well-known anti-friction additive and ZDDP has been used since a long time as an anti-wear additive for engine oils and other lubricants. It was particularly interesting to formulate grease with these additives and test their performance under spectrum loading conditions. About 3 wt. % of ZDDP & 2 wt. % of PTFE was used in Lithium base grease and the mixture was blend in a kitchen aid blender for about 2 hours in a similar way.
4. The fourth grease blend consisted of functionalized PTFE, ZDDP and MoDTC (Molybdenum Dithiocarbamate) in a ratio of 3:2:2 wt. %. This grease blend was tested so as to study the effect friction modifiers on the grease that contains a

mixture of PTFE & ZDDP. The MoDTC used was supplied by RT Vanderbilt under the commercial name Molyvan[®] A [116]. The three additives were first taken in the steel bowl of the kitchen aid and stirred manually with a spatula so that the PTFE gets functionalized with the dithiophosphate and dithiocarbamate functional groups. The Li-base grease is then added to this mixture and stirred in the kitchen aid for 2 hours as described in the section earlier.

The blended greases were tested in a four ball tribometer under spectrum loading conditions to evaluate the wear performance. Before testing the greases, they were stirred using a spatula so as to make sure of the consistency of the grease. If the blended greases are not used over a long period of time, there is a high probability of oil separation from the greases which is not beneficial as the greases wouldn't give an optimum performance.

3.2 Experimental setup

The aim of the current research work focuses at determining the AW and EP properties of greases when tested under varying conditions of load and rpm rather than when tested under ASTM D2266 [1] standard wherein the test parameters like the load, temperature and rpm or the sliding speed is maintained constant throughout the test which rarely happens in real-life applications. A four ball tribometer manufactured by Phoenix tribology formerly called as Plint tribology was used to test the greases. Once tested the four balls were then examined using various characterization techniques like SEM, SOM and EDS to determine the wear mechanism on the surface, the surface topography and to determine the WSD (Wear Scar Diameter); the friction coefficient was calculated using the formula as described in the appendix section of ASTM D5183, the formula uses torque and load parameters to calculate the friction coefficient. National Lubricating Grease Institute (NLGI) has developed a number of ASTM standards for testing of greases to determine their various characteristics before they are used in the industrial applications.

3.2.1 Four Ball Tribometer

The Four Ball Tribometer which is popularly called as “Four Ball Tribotester” or just the “Four Ball” is a machine which was developed around 1933 and is used to screen the AW and EP properties of lubricating oils and greases. The arrangement consists of three stationary balls which are held together in a clamp and the fourth ball that is held in a ball collet and slides over the three balls; this arrangement results in a wear scar over the three balls and a circular wear mark over the top ball. The lubricating medium that needs to be screened is placed in the cup wherein the three balls are held together by a clamp. The three wear scars are analyzed using various characterization techniques to understand the wear mechanism and WSD is determined. Figure 3.7 shows the schematic arrangement of the four ball geometry.

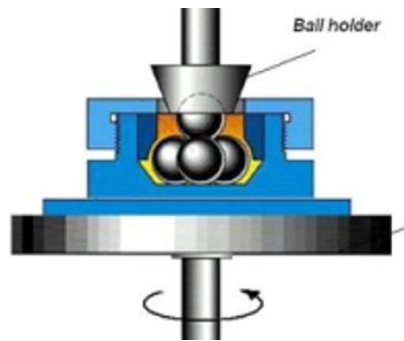

Fig 3.3 schematic representation of the four ball geometry [117]

According to the ASTM standard, the steel balls that are used in the test are made up of E52100 chrome coated steel and are of $\frac{1}{2}$ " diameter. The fourth ball on the top that is held in a ball collet makes point contact with the three balls at the bottom. According to the ASTM standard the test temperature of the lubricant to be tested is maintained at 75°C, a load of 40 Kg (392 N) and the sliding speed of 1200 rpm. The test is carried out for one hour and 72000 cycles. Once the test starts the point contact slowly starts to develop on the three balls at the bottom; after the end of the test the test balls are removed and the wear scar is analyzed for understanding the wear mechanism and WSD. The boundary lubrication regime is active throughout the test as the interacting surfaces make contact and asperities interact to produce

cold welds or abrasive wear or metal pull out. The lubricant tested is qualified is the WSD (Wear Scar Diameter) and the COF (Coefficient of Friction) are both minimal.

On the other hand the ASTM D2596 standard helps determine the seizure load or the weld load using different set of test conditions in a four ball machine. Lubricants are also screened for their properties like the Load Wear Index (which is an index of the capability of the tested lubricant to prevent wear at the given applied loads) and Weld Point (which is defined as the lowest applied load where in the sliding surfaces seize and then weld to each other terminating the test). One the balls are welded they are discarded after every test and the weld load is calculated in accordance to the procedure given in the ASTM standard. Figure 3.8 shows the four ball tribometer at the TLCL facility at UTA.



Fig 3.4 The Four Ball Tribometer at TLCL facility in UTA

The model number of the Tribometer used is TE 92 which is microprocessor controlled, the computer connected to it is installed with the CompendX software that forms an interface in between the programmed test condition file and the microprocessor which ultimately controls the machine. The tribometer is pneumatically loaded unlike the most dead-weight loaded tribometer. This arrangement is good as the load is slowly applied which doesn't cause an

increase in the WSD in the beginning of the test which is the case if the dead weight is directly loaded. The SLIM interface (Serial Link Interface Module) is a component in the control cabinet box in the machine which forms an interface in between the programmer and the machine. The test files can be programmed as preferred. The data file which contains all the data generated from the machine during the test is obtained and COF is calculated from the torque and load values in the data file. Torque and load are the actual values measured by the machine from the torque transducer and the load cell; however friction coefficient is the derived value that is calculated from the actual values. The TE 92 machine has the temperature range from 22°C to 150°C, speed range from 0 rpm to 3000 rpm and load range from 1 Kg to 800 Kg.

3.2.2 SEM (Scanning Electron Microscopy) and EDS (Energy Dispersive Spectroscopy)

SEM (model type: *Hitachi S-3000N*) was used to in the SE (Secondary Electron) mode to image the wear surfaces at a higher magnification of upto 400X & an acceleration voltage of 15-20 kV was used in all the cases. The Carbon tape was used to maintain good electrical contact in between the steel balls and sample holder. The wear mechanism in play on the surface as well as the tribofilm formed on the surface was evaluated.



Fig 3.5 SEM located in the CCMB facility at UTA

Specific areas on the surface which were of interest were imaged at a higher magnification. Only one ball for each of the three representative steel balls obtained in the test was analyzed using SEM. Figure 3.9 above shows the SEM along with the EDS unit mounted

onto it. The EDS is an essential tool that helps in determination of elements present on the surface. It's more of a qualitative technique rather than quantitative.

3.2.3 SOM (Stereo Optical Microscopy)

Stereo-Optical microscope (model type: *Nikon SMZ 1500*) was used to image the wear scars formed on the three stationary steel balls after the four ball tests.



Fig 3.6 Stereo Optical Microscope in the CCMB facility at UTA

The steel balls were cleaned using hexane and were mounted on a specially designed sample holder; which were then imaged at a magnification of 100X on the microscope. Figure 3.10 below shows the SOM that was used in the study. The scale was adjusted every time before the software was started. It was set in such a way that a magnification of 100X was obtained for the images. The images were analyzed using scaling software provided by Quartz Imaging Corporation. The software comprised of functions like Micron-marker or Pixel-marker which was used to document the WSD for all the three steel balls and an average value was reported.

3.2.4 Sputtering

A sputtering system (model type: *Torr International Inc. CrC-100*) was used for coating the PTFE with silver before it was imaged in the SEM. Without the sputter coating considerable surface charge accumulation occurs on PTFE and leads to image distortions and artifacts [118,119].



Fig 3.7 Sputtering machine located in the CCMB facility at UTA

MoS₂ in both milled and unmilled forms was imaged in the SEM to understand the structural and morphological characteristics of effects on milling. A small quantity of MoS₂ as well as PTFE was placed on the carbon tape that was stuck to the sample holder and was leveled before imaging. PTFE was imaged at a lower acceleration voltage of about 5 kV and a magnification of upto 200X to avoid image artifacts; however MoS₂ was imaged at an acceleration voltage of upto 15-20 kV and a magnification ranging from 400X to 1000X.



3.3 Test conditions matrix

This subsection deals with the various test conditions that were run in the study. As mentioned earlier, there were six different spectrum loading conditions where in the load and the rpm were varied to see the performance of the grease under these conditions rather than testing it under ASTM standard wherein the test parameters of load, temperature and rpm remain constant. The varying conditions of load and rpm are collectively known as “Spectrum Loading” conditions. These variations in the test can be programmed in a test file that can be executed in a Four Ball Tribometer. The four ball wear test was conducted in a continuous sliding mode under boundary lubrication regime where in the three balls at the bottom are clamped together in a holding cup and the top ball is rotated against the three balls, the lubricating medium is placed in between these interacting surfaces so as to test its properties.

There were about six different tests that were conducted in the study which were be classified on the basis of the variables that were altered during the test i.e. the load & speed.

The tests wherein the load was varied, while keeping other variables fixed was termed as “Cyclic Loading” tests and the tests wherein the speed was varied, while keeping other variables fixed was termed as “Cyclic Frequency” tests. The procedure for all the tests was in accordance to ASTM D2266 standards [1], the only variation being the load or the test parameters that were varied in a particular manner in every test. The ASTM method describes the test using three steel balls placed in a chuck that is locked using a cage and a fourth ball is rotated against the three stationary balls with the lubricating medium in between. This test is run at light loads so as to prevent any seizure or welding that would occur. However when running the tests in accordance to ASTM D2596 [120] to test the load wear index and weld loads, the loads prescribed by the method are quite higher as compared to ASTM D2266 standard. The table 3.5 below gives the details of various test conditions that were used in the study.

Table 3.3 Overview of different test conditions used in the research work

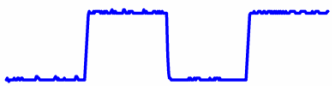
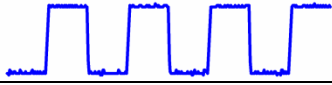
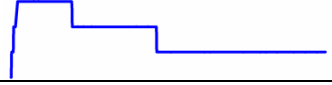
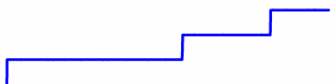
Test No.	Test Conditions	Type of Test	Constant Values	Graphical Representation
Test 1	80-40-80-40 (Kg)-15 min step	Ramp-down	1200 RPM, 75°C, 72000 cycles	
Test 2	80-40-80-40 (Kg)-7.5 min step	Ramp-down	1200 RPM, 75°C, 72000 cycles	
Test 3	40-80-40-80 (Kg)-15 min step	Ramp-up	1200 RPM, 75°C, 72000 cycles	
Test 4	40-80-40-80 (Kg)-7.5 min step	Ramp-up	1200 RPM, 75°C, 72000 cycles	
Test 5	1800-1200-600 (RPM) (13.3-20-40 (min))	Ramp-down	40 Kg, 75°C, 72000 cycles	
Test 6	600-1200-1800 (RPM) (40-20-13.3 (min))	Ramp-up	40 Kg, 75°C, 72000 cycles	

The four balls used in the study were made up of E52100 steel (Bearing quality aircraft grade steel) & were ½” in diameter. Out of the six tests described above, Tests 1-4 are known

as “Cyclic Loading” tests where in only the applied load is varied and rest of the parameters are held constant as specified in the ASTM D2266 standard; Tests 5-6 are known as “Cyclic Frequency” tests wherein only the speed or the rpm is varied keeping the other variables constant. These test conditions can be further subdivided into two categories: “Ramp-up” and “Ramp-down” tests.

Tests 1, 2 and 5 can be categorized under “Ramp-down” tests as the test begins at a higher load or frequency and terminates at a corresponding lower value. On similar lines Tests 3, 4 & 6 can be categorized under “Ramp-up” tests where the test begins at a lower load or frequency and terminates at a higher load or frequency. All the tests were run in duplicates to avoid any discrepancy in the data and had 72000 cycles maintained constant for each test. So basically what was done was that, the way in which 72000 cycles were applied was different wherein some cases the load was changed and in the other cases frequency was changed; even under the ASTM standard when the test is run at 1200 rpm for one hour, the test consists of 72000 cycles.

After the test was terminated, the three stationary steel balls were retrieved, cleaned and stored for analysis of the wear scar and calculation of the wear numbers. These steel balls were analyzed in various characterization tools like SEM, SOM and EDS to understand the wear mechanism in play, to determine the surface topography and to understand the nature of the tribofilm. The WSD (Wear Scar Diameter) is also determined using the images obtained from SOM. For each case only one representative ball was analyzed in the SEM, however all the balls were imaged in the SOM so as to get the WSD and to identify the single ball to be analyzed in the SEM.

CHAPTER 4

ROLE OF MoS₂ MORPHOLOGY ON WEAR & FRICTION COEFFICIENT UNDER SPECTRUM LOADING CONDITIONS

This chapter discusses the test results obtained from the two greases blended using unmilled MoS₂ & milled MoS₂ and an in-depth analysis of the wear surface is presented. This chapter also compares the torque and friction coefficient values obtained from the four-ball experiments. A correlation in between the morphology of the MoS₂ particles in reducing the wear numbers as well as friction coefficient is established. An effort is also made to understand the mechanism of formation of tribofilms from MoS₂ and its EP properties.

This chapter discusses the properties of the additives used and their advantages as well as disadvantages. A brief procedure which was followed to determine the WSD (Wear Scar Diameter) for the steel balls obtained from Four-ball tests is also discussed. A brief description of different characterization techniques like SEM (Scanning Electron Microscopy), Stereo-optical microscope which were used to analyze the wear mechanism, tribofilms and the wear surface are discussed as well.

4.1 Introduction

Greases are one of the oldest forms of lubricants dating back to 1400 B.C wherein ancient Egyptians used crude greases made up of animal fat mixed with lime for lubricating the wheels used in their chariots. However after the industrial revolution in 18th century there was a need to develop greases which could be used at high pressures, longer durations and a varying range of temperatures [25,26]. Grease can be defined as a semisolid lubricant consisting of thickeners dispersed in mineral or vegetable oil along with other additives. Greases are used in those mechanisms wherein lubricating oil cannot stay in place and where frequent lubrication is un-necessary. In the recent years, MoS₂ and Graphite have been extensively used as have

been used as extreme pressure additives in greases along with ZDDP (Zinc dialkyl dithiophosphate) and PTFE (Poly tetrafluorethylene) for improving the anti-wear and anti-friction capabilities of greases [115,121-124]. In a study by Gansheimer et al [125] it was shown that MoS₂ forms a thin lubricating film on the surface of the metal and when it is subjected to extreme frictional conditions MoS₂ reacts with the Fe substrate resulting in the diffusion of Mo into the metal and FeS being formed. A study by Risdon et al [121] showed that an increase in the MoS₂ content leads to an increase in the extreme pressure (EP) properties and an increased load-wear index.

In their research, Mistry et al [115] compared the lubricating properties of graphite and MoS₂ wherein it was shown that MoS₂ had superior load bearing and anti-seize capabilities. MoS₂ has been in use since several centuries as a dry lubricant [52]. MoS₂ is used as an additive in greases as well as oils that find applications in EP conditions. It can even be used for lubricating the two interacting surfaces by simply rubbing it on.

In the current study two different grease formulations are prepared in Lithium-base greases and are tested in a Four-ball tribometer. The ASTM D2266 standard prescribes specific test conditions to compare lubricating properties of greases, however actual application conditions vary significantly both in load and frequency and hence there is a need to examine the performance of greases under spectrum loading conditions. There were a total of six different test conditions studied wherein the load and the frequency or the speed are varied independent of each other in a cyclic manner to evaluate the effect of load and frequency on the wear scar formed on ½” steel balls made of E52100 grade steel. It was also ensured that when one of the test parameter was varied the other variables were held constant. The cyclic loading tests were categorized under Ramp-up & Ramp-down conditions wherein the tests were started with initial load of 40Kg and were ramped up to 80 Kg in the Ramp-up tests and vice versa. These tests were further classified on the basis of load step sizes of 7.5 min and 15 min each for each cycle. The rpm and test temperature were maintained at 1200 rpm and 75°C in the

cyclic loading tests. The cyclic frequency tests were classified as Ramp-up and Ramp-down conditions wherein the frequency was varied from 600 rpm to 1800 rpm in steps of 600 rpm and vice versa. The load and test temperature were maintained 40 Kg and 75°C in the cyclic frequency tests. The two different additives chosen for the study were: Techfine (Unmilled) MoS₂ and Milled MoS₂. The formulations were made in Lithium-base grease. They had treat levels of 3 wt. % of MoS₂.

The total number of cycles subjected in each test was for all the six different test conditions were held constant at 72000 cycles to minimize the effect of number of cycles. The tests were repeated to ensure reliability of wear numbers and the average values obtained from the tests were reported. The WSD (Wear Scar Diameter) was calculated for each test from each of the three stationary balls. The torque and the friction coefficient values obtained from the Four-ball machine are plotted and reported. The wear surface was evaluated using SEM (Scanning Electron Microscopy), Stereo-optical microscope and EDS (Energy Dispersive Spectroscopy). The type of wear mechanism in play was studied for each case. Since the actual applications require bearings to be subjected to varying conditions of load and frequency, the main objective of this research is to determine the wear performance of greases under spectrum loading conditions rather than testing it under the ASTM standards wherein the test parameters are held constant throughout the test.

4.2 Experimental procedure

4.2.1 Additive Chemistries and Formulation of Greases

A total of two grease blends were prepared in batches of approximately 200 grams. The Lithium-base grease used in the study was Texaco Marfak Multipurpose grease. It had a NLGI grade of 2 and had a dropping point of 188°C. The thickener type used was lithium 12-hydroxystearate. The grease had a kinematic viscosity of 220 cSt at 40°C. The color & texture were buttery & brown. The kitchen aid blender was used for blending and had a power rating of 250 W and a capacity of 1 gallon.

- i. The first grease blend was prepared using techfine or unmilled MoS₂ that was supplied by Climax Molybdenum (Phoenix, AZ). A total of 3 wt. % was used in the base grease. The average particle size of techfine grade MoS₂ was in a range of 5-20 μm. The mixture was blended using a kitchen aid blender for about 2 hours. After an interval of 15 to 20 min, the blender was stopped and a spatula was used to manually mix the content in the steel bowl of the blender which ensured homogeneity and adequate blending of the grease.
- ii. The second grease blend was prepared using ball-milled MoS₂. Techfine MoS₂ was mixed with hexane in 1:1 ratio and was taken in a 250 ml HDPE bottle. To this mixture 40 wt. % of zirconia balls of varying sizes (0.625 mm to 12.5 mm) were added. This entire mixture was then subjected to milling in a planetary ball-mill for 48 hours. Upon milling the content in the bottle was filtered through a steel mesh to separate the zirconia balls. After separation the filtrate consisting of hexane and milled MoS₂ was kept in the fume hood at room temperature for 24 hours to extract hexane. Hexane was used as a dispersant medium which made sure that particle agglomeration didn't occur during & post milling. 3 wt. % of ball-milled MoS₂ was then added to Li-base grease and mixed using a kitchen aid blender for about 2 hours in a fashion similar to unmilled MoS₂.

The blended greases were tested in a four ball tribometer to evaluate the wear and friction performance. Before testing the greases, they were stirred using a spatula so as to ensure the consistency of the grease.

Table 4.1 Overview of grease formulation and additives used

Sl. No	Type of base grease	Additive used	Weight % of additive
Blend 1	Lithium 12 hydroxystearate (NLGI grade 2)	Techfine MoS ₂ (Unmilled MoS ₂)	3 wt.%
Blend 2	Lithium 12 hydroxystearate (NLGI grade 2)	Ballmilled Techfine MoS ₂ (Milled MoS ₂)	3 wt.%

The table 4.1 below gives a brief overview of the grease formulations and the additives used.

4.2.2 Four-ball Tribometer tests

The four ball wear tests were conducted in a continuous sliding mode under boundary lubrication regime. There were six different tests that were conducted which could be classified on the basis of the variables such as load and speed that were altered during the test. The tests wherein the load was varied keeping other variables fixed were termed as “Cyclic Loading” tests and when the speed was varied while maintaining all other variables constant were termed as “Cyclic Frequency” tests. The test was conducted with three steel balls placed in a chuck that is locked using a cage and a fourth ball is rotated against the three stationary balls with the lubricating medium in between.

Table 4.2 Overview of different test conditions used in the study

Test No.	Test Conditions	Type of Test	Constant Values	Graphical Representation
Test 1	80-40-80-40 (Kg)-15 min step	Ramp-down	1200 RPM, 75°C, 72000 cycles	
Test 2	80-40-80-40 (Kg)-7.5 min step	Ramp-down	1200 RPM, 75°C, 72000 cycles	
Test 3	40-80-40-80 (Kg)-15 min step	Ramp-up	1200 RPM, 75°C, 72000 cycles	
Test 4	40-80-40-80 (Kg)-7.5 min step	Ramp-up	1200 RPM, 75°C, 72000 cycles	
Test 5	1800-1200-600 (RPM) (13.3-20-40 (min))	Ramp-down	40 Kg, 75°C, 72000 cycles	
Test 6	600-1200-1800 (RPM) (40-20-13.3 (min))	Ramp-up	40 Kg, 75°C, 72000 cycles	

The four balls are made up of E52100 steel (Bearing quality aircraft grade steel) & are 1/2” in diameter. The table 4.2 above details the various test conditions that were used in the

study. Tests 1 to 4 are known as “Cyclic Loading” tests and the tests 5 & 6 are known as “Cyclic Frequency” tests. Tests 1, 2 and 5 can be categorized under “Ramp-down” tests wherein the test begins at a higher load or frequency and terminates at a corresponding lower value. On similar basis Tests 3, 4 & 6 can be categorized under “Ramp-up” tests wherein the tests begin at a lower loads or frequency and terminate at a higher load or frequency. All the tests were run in duplicates to avoid any discrepancy in the data and had 72000 cycles maintained constant for each test. After the termination of every test, the three stationary steel balls were retrieved and analyzed to determine the WSD (Wear Scar Diameter). The tribofilm formed on the surface was analyzed and the wear mechanism was studied for each case.

4.2.3 Scanning Electron Microscopy (SEM) and Stereo-Optical Microscopy studies

Stereo-Optical microscope (model type: Nikon SMZ 1500) was used to image the wear scars formed on the three stationary steel balls after the four ball tests. The steel balls were cleaned using hexane and were mounted on a specially designed sample holder; which were then imaged at a magnification of 100X on the microscope. The images were analyzed using the software provided by Quartz Imaging Corporation. The software comprised of functions like Micron-marker & Pixel-counter which was used to document the WSD for all the three steel balls and an average value was reported.

SEM (model type: Hitachi S-3000N) was used to in the SE (Secondary Electron) mode to image the wear surfaces at a higher magnification of upto 400X & an accelerating voltage of 15-20 kV was used in all the cases. Carbon tape was used to maintain good electrical contact in between the steel balls and sample holder. The wear mechanism in play on the surface as well as the tribofilm formed on the surface was evaluated. Specific areas on the surface which were of interest were imaged at a higher magnification to understand the wear mechanism.

4.3 Results

The following section discusses the results obtained from the Four-ball tribometer, the wear numbers and an in-depth analysis of the wear surface using the SEM. The effect of

morphology on spectrum loading conditions is discussed & a correlation in between milled and unmilled MoS₂ is established with the help of torque, friction coefficient and WSD.

4.3.1 SEM analysis of the MoS₂ particles

The SEM images were obtained for both unmilled and milled MoS₂ at 500X and 1000X which correspond to lower and higher magnification at an acceleration voltage of 10 kV to 15 kV and a working distance of 14 mm to 15 mm. For the milled MoS₂ one can see that there is no agglomeration of MoS₂ particles as hexane was used as a dispersant during the milling operation.

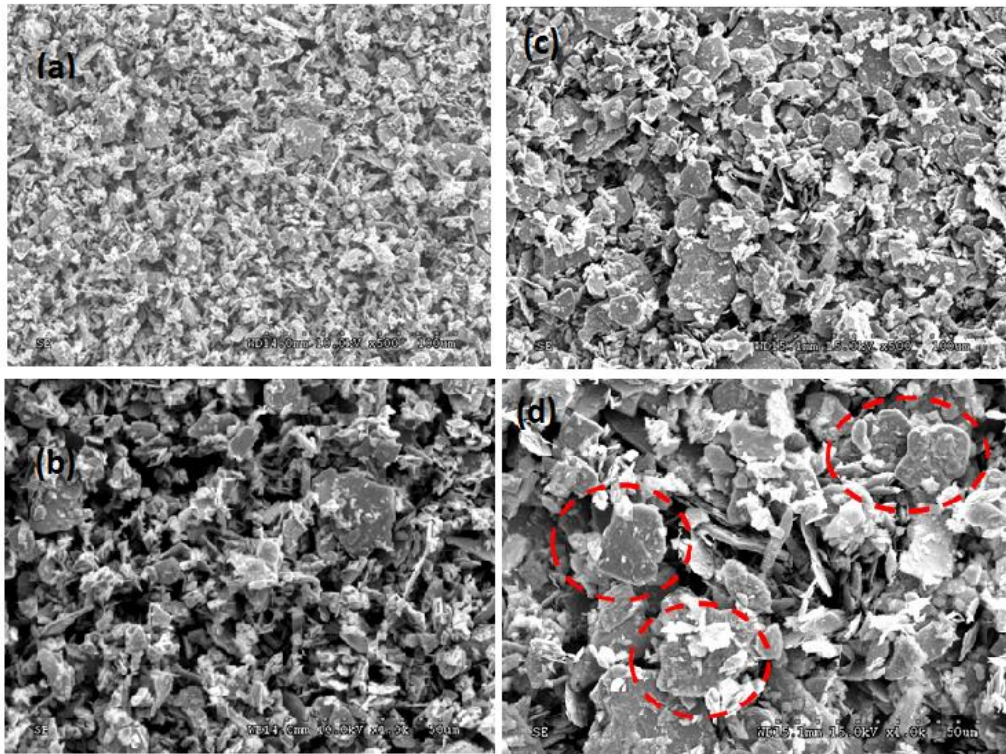

Fig 4.1 SEM images of (a) Unmilled MoS₂ at 500X (b) Unmilled MoS₂ at 1000X
(c) Milled MoS₂ at 500X (d) Milled MoS₂ at 1000X.

The figure 4.1 shows the SEM images of unmilled & milled MoS₂, wherein it can be clearly seen that the unmilled MoS₂ has sharp edges and corners as compared to the milled MoS₂ which is shown in red colored circular markings. These sharp particles are known to be

abrasive at lower loads and cannot be easily sheared due to which the coefficient of friction is higher when compared to the milled particles [2].

4.3.2 Analysis of Wear Scar Diameter (WSD)

The WSD was obtained for all the test balls using the method described in the section 4.2.3 and an average value was reported. The following figure 4.2 gives a representation of the wear numbers plotted in the form of a bar chart. Blend 1 corresponds to the grease blend formulated using unmilled MoS₂ and Blend 2 corresponds to the grease blend formulated using milled MoS₂ particles. Test 1 to Test 6 represent different set of spectrum loading conditions as summarized in Table 4.2. All the values for the WSD are reported in μm with their exact values inset at the center of each bar. The error bars represent the corresponding variation in the WSD values for each test. Upon comparing the results from both the blends for all the tests, it can be clearly seen that Blend 1 with unmilled MoS₂ particles exhibits a higher wear number than the blend containing milled MoS₂ particles. Also in both the blends the wear numbers obtained from cyclic frequency tests are lower than the wear numbers obtained from cyclic loading tests.

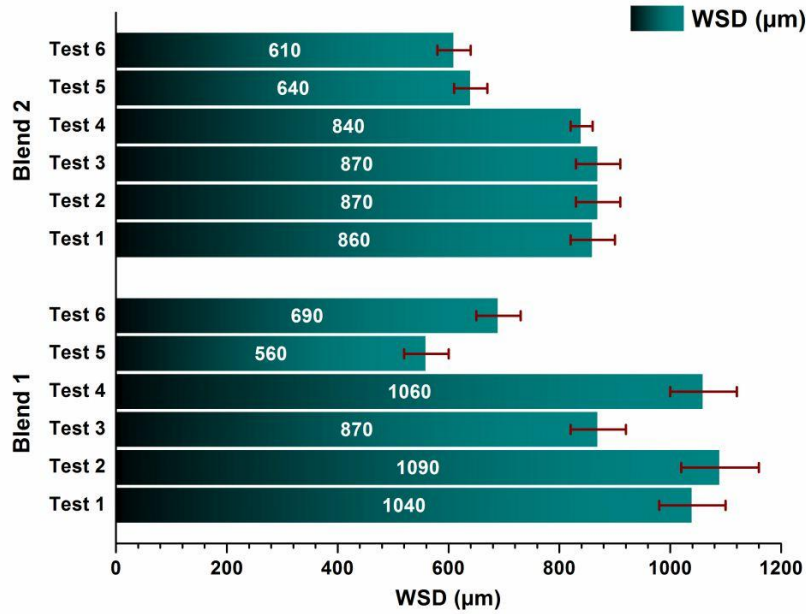

Fig 4.2 Wear Scar Diameters for Blend 1 & Blend 2

4.3.3 Torque and Coefficient of Friction (COF)

The torque and COF were obtained from the tests conducted using the Four-ball tribometer. Torque values are absolute whereas COF values are derived and hence had to be calculated using the procedure described in ASTM D5183-05 standard [126]. Figures 4.3 to 4.5 represent the torque and COF values for both the blends used in the study and for all six tests. The load values plotted are in kilonewtons (kN), the frequency or the sliding speed values are in rotations per minute (rpm) and the torque values generated are in newton-meters (Nm).

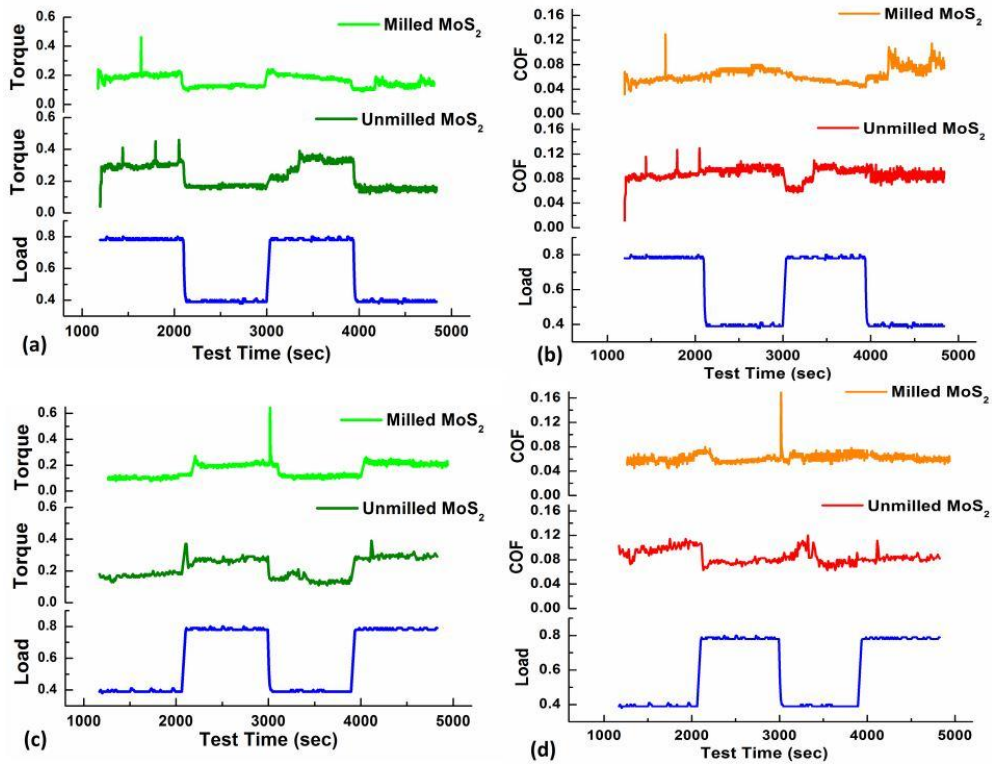

Figure 4.3 (a, c) Torque (Nm) and (b, d) COF values for cyclic loading conditions with a load step size of 15 minutes

The figures 4.3 & 4.4 compare the torque and friction response of the greases under cyclic loading conditions wherein the loads are varied throughout the test while other parameters held constant, on the other hand figure 4.5 compares the torque and friction

response of the greases under cyclic frequency conditions wherein the sliding speed is varied while maintaining the other parameters constant. On comparing the torque and COF values, a clear observation that can be made in all the cases is that the milled MoS₂ grease gives a much smoother variation in the torque and friction coefficient as well as lower absolute values when compared to the unmilled MoS₂ grease.

Figure 4.3 compares the ramp-up and ramp-down conditions under cyclic loading regime which have a load step size of 15 minutes. The load & torque values being plotted in kN and Nm respectively. Figures 4.3 (a, c) compare the torque responses for the unmilled MoS₂ & milled MoS₂ greases and the figures (b, d) compare the COF values of both the blends for corresponding loading conditions.

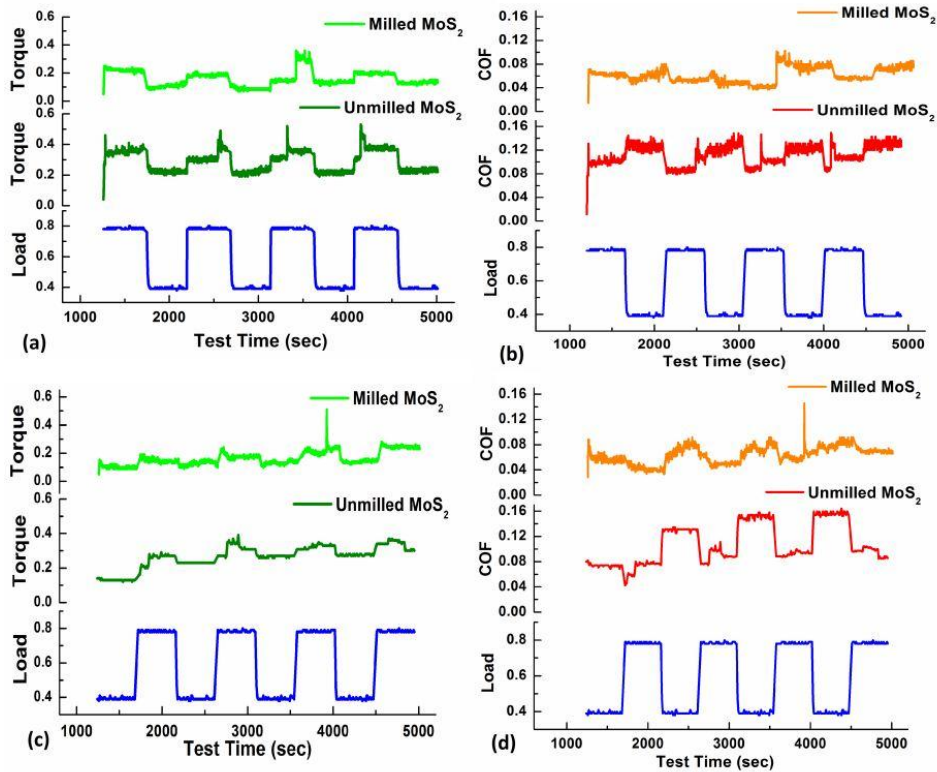

Figure 4.4 (a, c) Torque (Nm) and (b, d) COF values for cyclic loading conditions with a load step size of 7.5 minutes

Figures 4.3 (a, b) correspond to Test 1 and the ramp-down conditions while figures 4.3 (c, d) correspond to Test 3 and the ramp-up conditions. These tests consist of 4 load steps of 15 minutes, each consisting of 18000 cycles that result in a total of 72000 cycles throughout the test.

Figure 4.4 compares the ramp-up and ramp-down conditions under cyclic loading regime which have a load step size of 7.5 minutes. The load & torque values are plotted in the units of kN and Nm respectively. When the torque and friction output obtained from tests with load step sizes of 7.5 min is compared to the torque and friction output obtained from the tests with 15 min, it can be seen that larger the number of load variations the coarser is the corresponding output. In addition, the output obtained from unmilled MoS₂ grease has more excursions than the output obtained from milled MoS₂ grease. Figure 4.4 (a, c) compares the torque responses for the unmilled MoS₂ & milled MoS₂ greases and the figures (b, d) compare the COF values of both the blends for the corresponding loading conditions. Figures 4.4 (a, b) correspond to Test 2 and the ramp-down conditions while figures 4.4 (c, d) correspond to Test 4 and the ramp-up conditions. These tests consist of 8 load steps of 7.5 minutes, each consisting of 9000 cycles that result in a total of 72000 cycles throughout the test.

Figure 4.5 compares the ramp-up and ramp-down conditions under cyclic frequency regime which have a frequency step size of 600 rpm; under the ramp-down conditions the frequency or the sliding speed is decreased from 1800 rpm to 600 rpm in steps of 600 rpm whereas for ramp-up conditions the frequency or the sliding speed is increased from 600 rpm to 1800 rpm in steps of 600 rpm. The speed & torque values are plotted in the units of rpm and Nm respectively. Figure 4.5 (a, c) compare the torque responses for the unmilled MoS₂ & milled MoS₂ greases and the figures (b, d) compare the COF values of both the blends for the corresponding frequency conditions. Figures 4.5 (a, b) corresponds to Test 5 and the ramp-down conditions while figures 4.5 (c, d) correspond to Test 6 and the ramp-up conditions. These tests consist of 3 frequency steps, each consisting of 24000 cycles that result in a total of 72000

cycles throughout the test. The torque and COF variations in the case of cyclic frequency conditions are almost flat in both the blends. It is also observed that during the ramp-up tests at a frequency step of 1800 rpm, there is a drop in the COF in both the blends at higher rpm as the separation between the surfaces is increased reducing the asperity contacts thereby reducing the torque and friction coefficient.

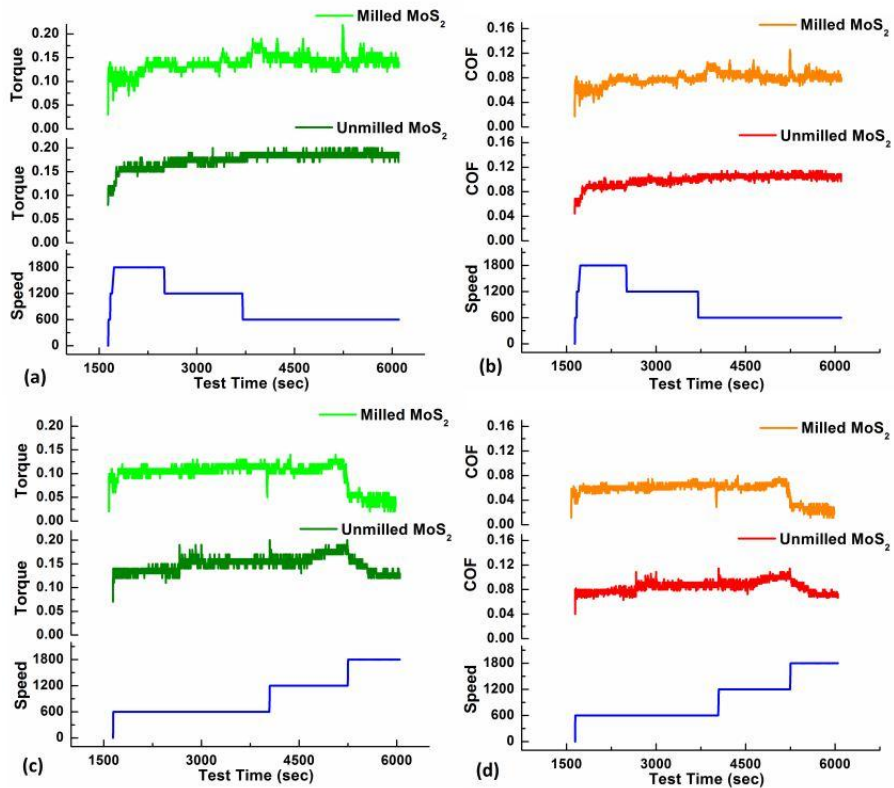

Figure 4.5 (a, c) Torque (Nm) and (b, d) COF values for cyclic frequency conditions with a frequency step size of 600 rpm

4.3.4 SEM analysis of the Wear surface

The SEM images for the wear surface were obtained for all the tests of both unmilled and milled MoS₂ grease at 80X and 400X which correspond to the lower and higher magnification images at an acceleration voltage of around 20 kV and a working distance of 14 mm to 16 mm. Figures 4.6 & 4.7 compare the SEM images of unmilled MoS₂ grease at 80X and

400X while figures 4.8 & 4.9 compare the SEM images of milled MoS₂ grease at 80X and 400X. Figures 4.7 & 4.9 illustrate the representative areas shown enclosing the boxes in the figures 4.6 & 4.8; for all the test conditions the nature of wear mechanism and all the details pertaining to surface topography are explained. The scale for the SEM images is displayed using a micron marker.

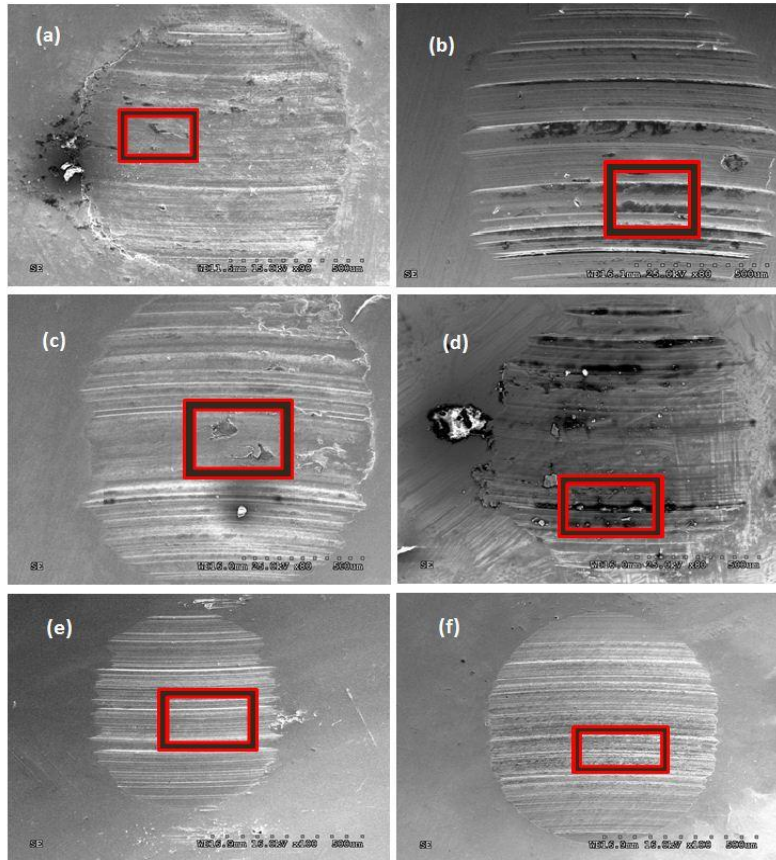

Figure 4.6 Low magnification SEM images for Unmilled MoS₂ grease wherein (a to f) represent the images from Test 1 to Test 6

Figure 4.6 represents the low magnification SEM images for the wear surface obtained from unmilled MoS₂ grease at 80X. The representative boxes show the area of interest which is further magnified to study the wear mechanism. The images 4.6 (a-d) correspond to cyclic loading conditions and the images 4.6 (e & f) represent the cyclic frequency conditions. An

observation that can be made is that, since all the images were taken under similar conditions in a SEM, it can be clearly seen that the cyclic loading tests have a larger WSD as compared to the cyclic frequency conditions. Figure 4.7 represents the high magnification SEM images for the wear surface obtained from Unmilled MoS₂ grease at 400X.

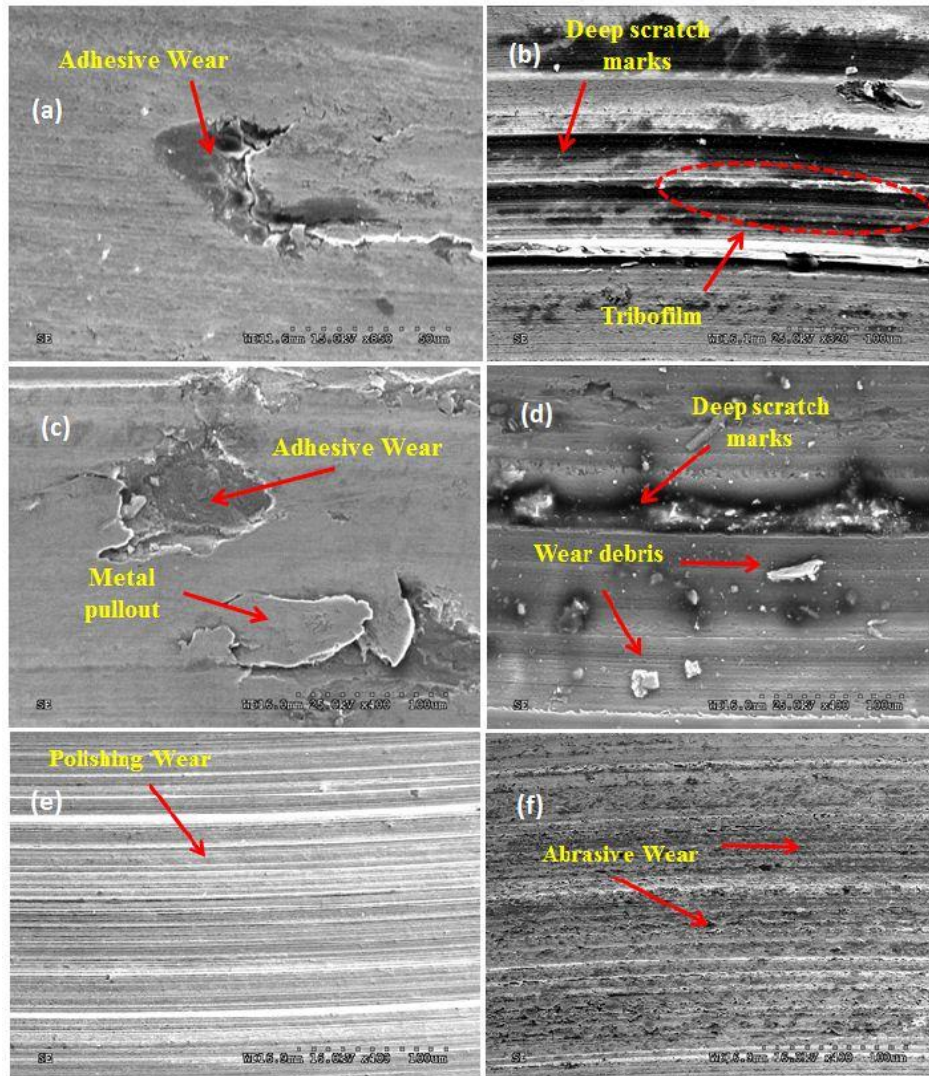

Figure 4.7 High magnification SEM images for Unmilled MoS₂ grease wherein (a to f) represent the images from Test 1 to Test 6

These images represent the area enclosed in the boxes as shown in figure 4.6. The images 4.7 (a-d) correspond to cyclic loading conditions and the images 4.7 (e & f) represent

the cyclic frequency conditions. A rough comparison in between the images taken at cyclic loading and cyclic frequency shows a large amount of wear for the cyclic loading tests as compared to the cyclic frequency tests. There is also a presence of excessive amount of abrasive wear and metal removal for cyclic loading tests as compared to the presence of polishing wear in the cyclic frequency tests.

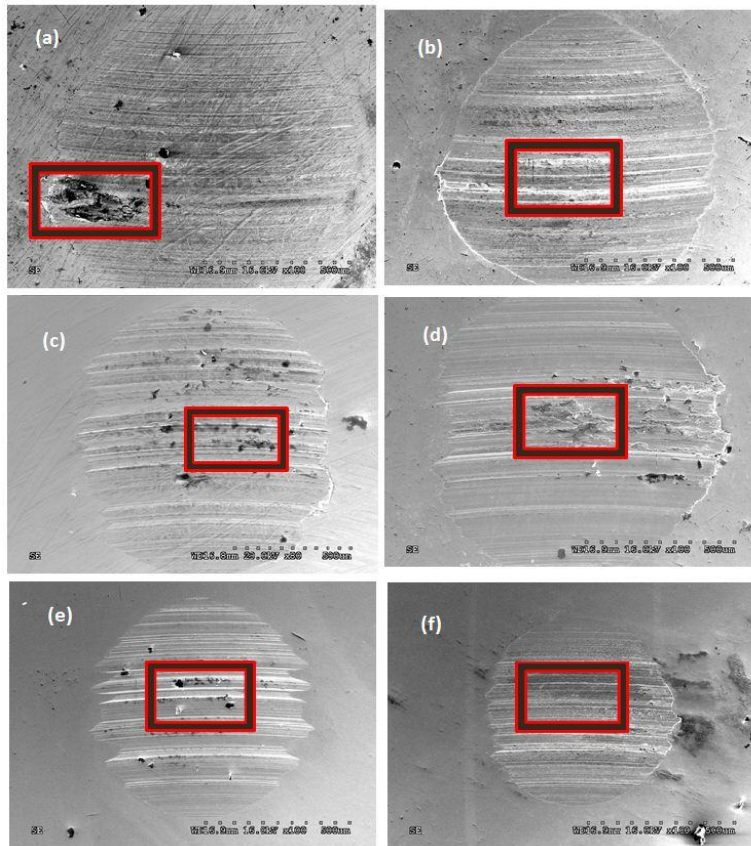

Figure 4.8 Low magnification SEM images for Milled MoS₂ grease wherein (a to f) represent the images from Test 1 to Test 6

Figure 4.8 represents the low magnification SEM images for the wear surface obtained from Milled MoS₂ grease at 80X. The representative boxes show the area of interest which is further magnified to study the wear mechanism. The images 4.8 (a-d) correspond to cyclic loading conditions and the images 4.8 (e & f) represent the cyclic frequency conditions. On

comparison with figure 4.6, there is a difference with respect to the amount of wear on the surface.

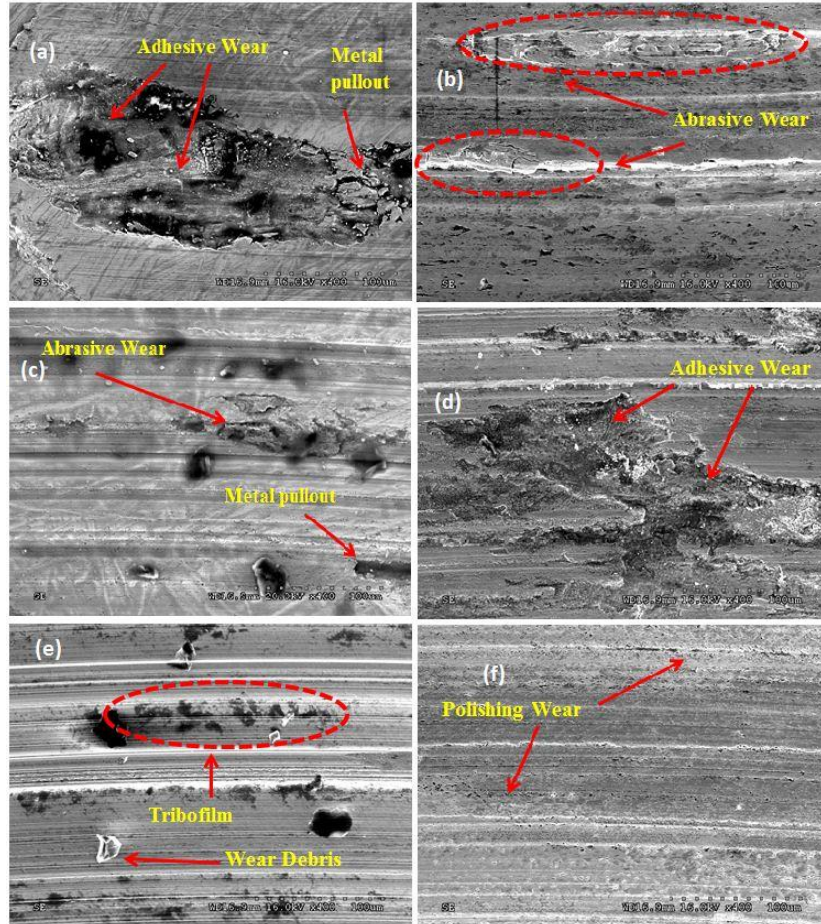

Figure 4.9 High magnification SEM images for Milled MoS₂ grease wherein (a to f) represent the images from Test 1 to Test 6

Unmilled MoS₂ grease gives a greater amount of metal removal and abrasive wear as compared to milled MoS₂ grease. It is evidently seen that the images for cyclic frequency conditions show smaller amount of wear as compared to the cyclic loading conditions.

Figure 4.9 represents the high magnification SEM images for the wear surface obtained from milled MoS₂ grease at 400X. These images were taken to study the nature of the tribofilm formed on the surface as well as to study the wear mechanism that was active on the surface

during the test; these images represent the area enclosed in the boxes as shown in figure 4.8. The images 4.9 (a-d) correspond to the cyclic loading conditions and the images 4.9 (e & f) represent the cyclic frequency conditions. Upon observation of the images it can be identified that abrasive wear mechanisms, metal pull-out are dominant mechanisms in cyclic loading conditions whereas polishing wear seems to be evident in cyclic frequency conditions. There is also a presence of tribofilms on the wear surface that protects the surface from further wear and abrasion decreasing wear numbers.

4.4 Discussions

The following section discusses the effect of particle morphology and its outcome on the cyclic loading & cyclic frequency conditions. The wear mechanisms and the nature of tribofilms formed on the wear surface and its role in protecting the surface from further abrasion are discussed. A correlation in between milled and unmilled MoS₂ grease is established with the help of torque values, friction coefficient, WSD and analysis of wear scar morphology.

4.4.1 Effect of particle morphology

During the study it was hypothesized that removal of the sharp edges and the corners of the MoS₂ particles would lead to a lower amount of wear and possibly have a positive effect on reduction of coefficient of friction (COF) while maintaining its load bearing capabilities. It has been proven in the previous studies [2,127], the abrasive nature of MoS₂ particles was responsible for an increased wear and friction. Removal of these edges was done by ball-milling the MoS₂ particles; upon close observation of unmilled & milled MoS₂ particles it is very clear that the sharp edges and corners have been broken down by the milling process resulting in smooth and rounded edges. Figure 4.1 (d) shows the particle morphology after milling wherein the edges are rounded, thereby leading to reduction in the wear and friction. On the other hand from figure 4.1 (b) shows the sharp corners of the unmilled MoS₂ particles which if not oriented in the direction of shearing would scrape through the wear surface leading to abrasive wear, ploughing grooves and metal pull-out. A previous study by Suresh et al, [2] has also established

that a threshold amount of 3 wt. % of MoS₂ has to be used while formulating the greases so as to benefit from the EP properties; however the study also resulted an increased amount of wear upon increasing the MoS₂ content to 5 wt. % at lower loads. At 5 wt. % the WSD was found to increase with a higher rpm.

MoS₂ has long been used as an EP additive and is well known for its load bearing capabilities; the MoS₂ particles have to orient in the direction of shearing while passing through the interacting surfaces so that the layers get sheared which in-turn deposit on the surface forming a tribofilm that leads to an increase in the load bearing capability while protecting the surface from further abrasion [56,58,115,121]. Several studies have proposed different friction mechanisms for MoS₂ particles like intrinsic cleavage mechanism, adsorption mechanism theory and inter-crystallite slip mechanism which explain the effectiveness of MoS₂ as an EP additive [55,63,128]. If these particles have sharp edges and not oriented in the direction of shearing then it leads to an increased wear and friction. Upon milling, since most of the sharp edges are rounded the amount of wear for un-oriented particles is comparatively less as it is evident from the wear numbers for Blend 2 as shown in the figure 4.2.

4.4.2 Effect of cyclic loading conditions

In the current study an effort is made to understand the effects of varying loads & different step sizes on the wear and friction performance of the greases containing unmilled and milled MoS₂ particles as EP additives. Cyclic loading conditions correspond to the Tests 1 to 4 and are further classified into ramp-up and ramp-down tests with load step sizes of 15 min and 7.5 min each. Tests 1 & 2 are ramp-down tests wherein the test begins at a higher load of 80 Kg and terminates at a lower load of 40 Kg, while Tests 3 & 4 are ramp-up tests wherein the test begins at a lower load of 40 Kg and terminates at a higher load of 80 Kg.

Figure 4.2 represents the WSD for Blend 1 and Blend 2 grease which corresponds to the unmilled & milled MoS₂ grease. When the wear numbers for Tests 1 to 4 are compared for both the blends it can be clearly distinguished that the Blend 2 grease containing milled MoS₂

particles exhibit almost 20% less amount of wear as compared to the Blend 1 grease containing unmilled MoS₂ particles. When the tolerances for the wear numbers represented by the error bars are compared it can be observed that there is a wider distribution trend for the wear numbers obtained from unmilled MoS₂ grease pointing towards the fact that the sharp edges and corners of the MoS₂ particles were responsible for large amount of abrasive wear and material removal; on the other hand the tolerances for the Blend 2 grease containing milled MoS₂ particles give a narrower distribution trend and correspondingly smaller WSD which was attributed to the presence of rounded edges of the milled MoS₂ particles.

On comparison of the torque & coefficient of friction (COF) from figure 4.3 & figure 4.4 it can be seen that Blend 2 containing milled MoS₂ particles exhibit a smoother trend of both the torque & COF as compared to Blend 1 containing unmilled MoS₂ particles. The sharp spikes that are visible in the torque and COF for all the tests were thought to correspond to particular events occurring on the wear surface like abrasive wear, adhesive wear, metal pull-out, deep scratch marks or ploughing grooves during the test which lead to an increased friction since COF is a quantity derived from the torque values; the occurrences of the spikes in the COF curves correspond to the spikes in the torque output. Another trend that can be seen for all the cases is the presence of a small surge in the torque and COF values when the load is changed from 40 Kg to 80 Kg; this particular trend is much more visible for unmilled MoS₂ grease. The MoS₂ particles present in between the interacting surfaces that are not oriented in the direction of shearing during an increase in the load tend to remove a larger amount of material than at lower loads. This material removal increases the load on the torque arm leading to a small surge in the torque and COF.

It can also be seen that the load and COF are inversely related for MoS₂ greases, upon increase in the load there is an increase in the torque, however this increase in torque is not proportional to the increase in the applied load leading to a decrease in the COF. It has been reported by several studies [2,67,69], that the lower loads are insufficient for shearing of MoS₂

particles thereby leading to an increase in the friction, however at higher loads the weak Van der Waals forces present in between the hexagonal Mo and S layers are overcome leading to shearing of the layers at the S-S interface which physically deposit on the wear surface increasing the wear-load thereby preventing the seizure of the surfaces. Temperature and moisture also play a significant effect on the lubricating properties of MoS₂. The presence of moisture results in poor wear properties while its performance in dry air or an inert environment like argon gives a considerable improvement in its properties [129]. In a study on role of moisture on wear characteristics of MoS₂ by Gao et al [130] it has been shown that the presence of moisture leads to a softening of MoS₂ particles leading to a thinner film on the interacting surface thereby reducing its load bearing capabilities and a poor wear performance.

On comparison of the tests in figures 4.3 and 4.4 with load steps of 15 min & 7.5 min, it is observed that higher number of changes in the load per test leads to an increased amount of wear and COF. The cyclic loading tests with a load step size of 15 min exhibit a comparatively smoother distribution of torque and COF as compared to the tests with load step size of 7.5 min. If figure 4.4 which plots the torque & COF for tests with 7.5 min load steps is compared to figure 4.3 that plots the torque & COF values for tests with 15 min load steps, it can be established that higher number of ramping up and ramping down of the loads yields higher wear and COF values. When ramp-up conditions are compared to ramp-down conditions for both the grease blends, it is seen that ramp-up conditions exhibit a comparatively lower wear & COF values. When figure 4.3 (c) is compared to figure 4.3 (a) and figure 4.4 (c) compared to figure 4.4 (a), it is evident that ramp-up conditions which begin at a lower load and terminate at a higher load show a smoother variation in the torque and corresponding COF values; lower loads at a given sliding speed result in the formation of a stable tribofilm on the interacting surface which limits the abrasion of the surface when the load is ramped up. However in the case of ramp-down conditions where the tests begin at higher loads and terminate at lower loads, the MoS₂ particles which pass through the interacting surfaces in a manner that are not oriented in the

direction of shearing, leads to an enormous amount of wear that increases the torque arm load leading to a higher COF.

The average value of coefficient of friction values for Blend 1 grease containing unmilled MoS₂ particles & Blend 2 grease containing milled MoS₂ particles are 0.07 to 0.15 and 0.05 to 0.085 respectively. There is about 35% reduction in the COF values for Blend 2 grease with milled MoS₂ particles as compared to Blend 1 grease containing unmilled MoS₂ particles for identical test conditions. This can be mainly attributed to the particle morphology wherein most of the sharp edges and corners present on the MoS₂ particles responsible for higher wear and friction are eliminated by ball milling that leads to smoother and rounder MoS₂ particles.

SEM images were taken at low and high magnification to understand the wear mechanism and surface topography that results after end of the tests. Figures 4.6 & 4.7 represent the low & high magnification SEM images for the Blend 1 grease containing unmilled MoS₂ particles while figures 4.8 & 4.9 represent the low & high magnification SEM images for the Blend 2 grease containing milled MoS₂ particles. A preliminary difference that is evident from figures 4.6 & 4.8 is that the wear scar diameter (WSD) for Blend 2 grease is smaller than the WSD for Blend 1 grease in all the cases. The WSD results plotted in figure 4.2 suggests that for Blend 2 grease, there is a drop in WSD values only in the case of cyclic loading tests however there very little variation in the WSD for Tests 5 & 6 which is cyclic frequency conditions. This leads to one more observation that the particle morphology has a significant effect under cyclic loading conditions but not on the cyclic frequency conditions. Figures 4.7 & 4.9 show high magnification images for the two blends that represent the enclosed areas in the corresponding figures of 4.6 & 4.8; for Blend 1 grease, on comparison of figures 4.7 (a to d) which correspond to cyclic loading conditions, shows proof of rough surface with the presence of abrasive wear, adhesive wear, metal pull-out, deep grooves or scratch marks that is a result of unmilled MoS₂ particles which are known to be highly abrasive. Figure 4.7 (b & d) correspond to the Tests 2 & 4 that have a load step size of 7.5 min and hence the number of variations in

the load is higher which leads to a rougher surface, higher torque and COF & a corresponding higher wear scar diameter as shown in figure 4.2. There is strong evidence of formation of tribofilm on the wear surface in figure 4.7 (b) which is beneficial in terms of increased load bearing capabilities. The presence of wear debris in figure 4.7 (d) shows signs of adhesive wear leading to cold weld of asperities on the wear surface. Figures 4.7 (a & c) represent Tests 1 & 3 which have load step size of 15 min; the wear surface shows abrasive wear accompanied by polishing wear. Figures 4.9 (a to d) represent the cyclic loading conditions for Blend 2 grease. There is no evidence showing ploughing grooves or deep scratch marks on the wear track that is thought due to the elimination of sharp edges and corners present on the unmilled MoS₂ particles. These rounded edges are responsible for the reduction of WSD and COF. However there is a presence of abrasive wear & polishing wear on the interacting surfaces. Small patches of tribofilm are also formed on the surface.

4.4.3 Effect of cyclic frequency conditions

Cyclic frequency conditions correspond to the Tests 5 & 6 and can be further classified into ramp-down and ramp-up tests. These tests have a frequency step size of 600 rpm. Test 5 is a ramp-down test that begins at 1800 rpm and terminates at 600 rpm while Test 6 is a ramp-up test that begins at 600 rpm and terminates at 1800 rpm. Figure 4.2 represents that WSD for both the grease blends. On comparing the WSD for Tests 5 & 6, no major variation is seen in the WSD for the Blend 1 & Blend 2 grease containing unmilled & milled MoS₂ particles. The wear number distribution which is represented by the error bars for tests 5 and 6 shows minimal variation for both the grease blends suggesting the notion that particle morphology has very less effect on the wear numbers under cyclic frequency conditions and ball-milling of MoS₂ particles has a marginal effect in improving the WSD.

Figure 4.5 is a plot of the torque and COF values for the ramp-up and ramp-down tests. A primary observation of these graphs reveals that at 1800 rpm the torque and COF values significantly drop for all the cases; at higher rpm and constant loads the smaller MoS₂ particles

would be responsible for the load bearing capability of the grease as they can enter interacting surfaces without much resistance at high grease flow rates, however larger particles have a lower probability of entering the area in between the interacting surfaces and are thought to freely circulate in the medium with less contribution towards the EP effects of the grease. The number of smaller MoS₂ particles is significantly less as compared to the larger particles; since the number of abrasive particles that interact with the surface in the case of Blend 1 grease is less, it results in a lower WSD and less wear on the surface as it is evident from the figure 4.2. The COF values significantly drop as they are derived from the load and torque.

It is well known from the principles of boundary lubrication and the Stribeck curve that with an increase in the sliding speed of the surfaces or an increase in the fluid viscosity the separation in between the opposing surfaces is increased resulting in a mixed or a hydrodynamic lubrication regime depending on the thickness of the lubricant layer which is present in between the interacting surfaces. When the separation in between the surfaces is more than the height of asperities, it leads to a significant drop in the COF and wear of the surfaces as the asperities no longer touch each other which might have led to an abrasive or adhesive wear and the formation of wear debris that would increase the WSD [17,24,131-133]. During the ramp-down tests as indicated in the figure 4.5 (a & b), it can be seen that the torque and COF values in the beginning of the tests are lower when the sliding speed is 1800rpm and slowly rise towards the end of the test when the sliding speed is 600 rpm. With a reduction in the sliding speed the surfaces come closer to each other increasing the likelihood of asperity contact resulting in wear of the surface. During the ramp-up tests as shown in figure 4.5 (c & d), it is observed that at 1800 rpm there is a sharp decrease in the torque and COF values for both the grease blends as the lubrication regime enters the mixed or hydrodynamic lubrication regime reducing the asperity contact that leads to a reduction in the wear and a reduced motor load which is displayed as a sharp plunge in the torque and COF values.

Comparison of the SEM images of the wear track for the grease containing unmilled and milled MoS₂ particles shows minimal signs of abrasive or adhesive wear and very less number of ploughing grooves. Figure 4.6 (e & f) as well as figure 4.8 (e & f) represent low magnification images for Blend 1 and Blend 2 grease respectively; no significant differences are observed on the wear surfaces, this observation correlates the wear numbers for Test 5 and Test 6 for both blends shown in figure 4.2. Figure 4.7 (e & f) and figure 4.9 (e & f) show the high magnification SEM images of the wear surface that represent the areas enclosed in the corresponding low magnification SEM images in figures 4.6 and 4.8. The topography of the wear surface shows prominent presence of polishing wear with little evidence of severe wear phenomenon occurring on the surface. For the Blend 1 grease containing unmilled MoS₂ particles, there is a small presence of abrasive wear in certain areas as shown in figure 4.7 (f), for Blend 2 grease containing milled MoS₂ particles there is evidence of tribofilm formation on the surface in the form of patches due to the deposition of MoS₂ layers that protects the surface from further abrasion & wear.

4.5 Conclusions

The current study was focused on developing & testing of high performance greases with optimum AW/EP properties under spectrum loading conditions. The research emphasizes on solving the issue of abrasiveness of MoS₂ particles at lower loads while improving its load bearing capabilities. Some of the conclusions drawn are:

1. Due to the morphology of the unmilled MoS₂ particles, they behave as a pro-abrasive agent at lower loads which are not sufficient to overcome Van der Waals forces present at the S-S layer interface in the MoS₂ structure which is responsible for shearing of lamellar layers forming a tribofilm on the wear surface.
2. The morphology of the MoS₂ particles has a significant effect on the wear and frictional performance of the greases under spectrum loading conditions. Milled MoS₂ particles owing to

their rounded edges and blunt corners yield lower wear numbers and COF values when compared to the grease containing unmilled MoS₂ particles.

3. Under cyclic loading conditions where the sliding speed or the rpm of the opposing surfaces is fixed, higher the number of load changes leads to higher wear of the surface. The results obtained for tests with load steps of 7.5 minutes exhibit higher amount of wear and COF as compared to the tests with load steps of 15 minutes.

4. Cyclic frequency conditions where loads are maintained constant do not show a significant change in the wear & friction data for both the grease blends under ramp-up and ramp-down conditions; however at higher frequencies, the lubricating regime slowly changes to mixed lubrication or hydrodynamic lubrication regime increasing the separation of opposing surfaces reducing the asperity interaction leading to a decrease in the wear & COF values.

5. Under cyclic loading conditions, the ramp down tests exhibit relatively higher wear and COF values as compared to the ramp-up tests; a protective tribofilm is formed on the wear surface initially at lower loads in the ramp-up tests that protects the wear surface from wear and abrasion at higher loads.

CHAPTER 5

COMPARISON OF FRICTION AND WEAR PERFORMANCE OF MoS₂ & NON-MoS₂ GREASES UNDER SPECTRUM LOADING CONDITIONS

This chapter discusses the test results obtained from the two greases blended using MoS₂ particles and a combination of ZDDP/PTFE; an in-depth analysis of the wear surface and the wear mechanism is presented. This chapter compares the torque and friction coefficient values obtained from the four-ball experiments. A correlation of the synergy in between ZDDP & PTFE in reducing the wear numbers as well as coefficient of friction is established. An effort is also made to understand the mechanism of formation of tribofilms from the additive chemistries & their AW/EP properties.

Four-ball tests were carried out for screening of AW/EP properties of the greases and the WSD (Wear Scar Diameter) for the steel balls obtained from Four-ball tests is determined. A brief description of different characterization techniques like SEM (Scanning Electron Microscopy), Stereo-optical microscope which were used to analyze the wear mechanism, tribofilms and the wear surface are discussed as well.

5.1 Introduction

Greases can be considered as semi-solid lubricants consisting of a thickener material which is generally a soap that is dispersed in mineral or synthetic oils. Greases have gained prominence in the lubricant industry since the onset of industrial revolution wherein machine parts had to be lubricated and lube oils had limited effectiveness. They are used in applications wherein lube oils can't stay in place and frequent lubrication is unnecessary. Soaps of lithium, calcium & sodium are commonly used as thickeners that form a large entanglement network that is responsible for trapping the oil [26,134-136]. The rheological as well as lubricating

properties of the grease depend on its constituents & the microstructure achieved during its production.

MoS₂ has been used as a solid lubricant as well as an EP additive for greases and lubricating oils for quite some time; among others graphite, PTFE & talc are commonly used solid lubricants. The lamellar structures of the MoS₂ & graphite particles are mainly responsible for their load bearing capabilities wherein the layers that are interconnected by weak Van der Waals forces are sheared and deposited onto the interacting surfaces thereby preventing the contact in between asperities and protecting the surface from further wear & abrasion [137-141]. ZDDP has been widely used as an anti-wear (AW) additive and as a mild anti-oxidant as well. ZDDP forms protective tribofilms that are hard and glassy in nature; the other advantages that ZDDP has is the ease of manufacturing and low costs. ZDDP has been extensively used in engine oils owing to these properties; however ZDDP is responsible for poisoning of catalytic converters which leads to release of poisonous gases in the atmosphere. ZDDP is also used for greases as an effective AW additive which is generally used at lower operating temperatures [82,142-145].

PTFE on the other hand has been used as a friction modifier either by itself or in a lubricant. PTFE has known to increase the load bearing capability when used with grease [146]. In a study by Stolarski et al [147,148], it was found out that a thin layer of PTFE adheres to the interacting surface due to a physical reaction in between PTFE and the metal substrate. It was also shown that due to the mechanical fracture of PTFE chain, chemical reactions are induced on the interacting surfaces where asperity contact is the highest. However under prolonged loads, PTFE suffers from cold-flow and leads to an increase in the wear rate. In some of the recent studies, a combination of ZDDP and PTFE is known to be synergistic that yields superior wear and weld performance. Suresh et al [2,74], used irradiated PTFE that had carboxylic functionality with a combination of ZDDP; they reported strong synergism in between the ZDDP and PTFE used in greases. In a study by Aswath et al [149], strong interaction in between

fluorinated-ZDDP and functionalized-PTFE is suggested that gives superior wear and weld performance for oils and greases.

In the current study two different grease formulations are prepared in Lithium-base greases and are tested in a Four-ball tribometer in accordance to ASTM D2266 standard. There were a total of six different test conditions studied wherein the load and the frequency or the speed are varied independent of each other in a cyclic manner to evaluate the effect of load and frequency on the wear scar formed on ½" steel balls made of E52100 grade steel. It was also made sure that when one of the test parameter was varied, rest of the parameters was held constant as prescribed in the ASTM standard. The cyclic loading tests were categorized under Ramp-up & Ramp-down conditions wherein the tests were started with initial load of 40Kg and were terminated at a final load of 80 Kg and vice versa. These tests were further classified on the basis of load step sizes of 7.5 min and 15 min each. The rpm and test temperature were maintained at 1200 rpm and 75°C. The cyclic frequency tests were classified as Ramp-up and Ramp-down conditions wherein the frequency was varied from 600 rpm to 1800 rpm in steps of 600 rpm and vice versa. The load and test temperature were maintained at 40 Kg and 75°C. The two different additives chosen for the study were: MoS₂ and a combination of ZDDP & PTFE having a carboxylic functionality. The formulations were made in Lithium-base grease. The grease containing MoS₂ particles had a treat level of 3 wt. % and the grease containing ZDDP & PTFE had treat levels of 3 wt. % and 2 wt. % respectively.

The total number of cycles subjected in each test was for all the six different test conditions were held constant at 72000 cycles. Duplicates of the test were run to confirm the wear numbers and the average values obtained from both the tests were reported. The WSD (Wear Scar Diameter) was calculated for each test. The torque and the friction coefficient values obtained from the Four-ball machine are plotted and reported in the following study. The tribofilm formed on the wear surface was evaluated using SEM (Scanning Electron Microscopy), Stereo-optical microscope and EDS (Energy Dispersive Spectroscopy). The type of wear

mechanism in play was studied for each case. Since the actual applications require bearings to be subjected to varying conditions of load and frequency, the main objective of this research is to determine the wear performance of greases under spectrum loading conditions rather than testing it under the ASTM standards wherein the test parameters are held constant throughout the test.

5.2 Experimental procedure

5.2.1 Additive Chemistries and Formulation of Greases

A total of two grease blends were prepared in batches of approximately 200 grams. The Lithium-base grease used in the study was Texaco Marfak Multipurpose grease. It had a NLGI grade of 2 and had a dropping point of 188°C. The thickener type used was lithium 12-hydroxystearate. The grease had a kinematic viscosity of 220 cSt at 40°C. The color & texture were buttery & brown. The kitchen aid blender was used for blending and had a power rating of 250 W and a capacity of 1 gallon.

- i. The first grease blend was prepared using techfine MoS₂ that was supplied by Climax Molybdenum (Phoenix, AZ). A total of 3 wt. % was used in the base grease. The average particle size of techfine grade MoS₂ was in a range of 5-20 µm. The mixture was blended using a kitchen aid blender for about 2 hours. After an interval of 15 to 20 min, the blender was stopped and a spatula was used to manually mix the content in the steel bowl of the blender which ensured homogeneity and adequate blending of the grease.
- ii. The second grease blend was prepared using a mixture of functionalized PTFE (Poly tetrafluorethylene) and ZDDP (Zinc dialkyl dithiophosphate). In general PTFE is a well-known anti-friction additive and ZDDP has been used since a long time as an anti-wear additive for engine oils and other lubricants. It was particularly interesting to formulate grease with these additives as they are known to be synergistic and to test their performance under spectrum loading conditions. About 3 wt. % of ZDDP & 2 wt. % of

PTFE was used in Lithium base grease and the mixture was blend in a kitchen aid blender for about 2 hours in a similar manner.

The blended greases were tested in a four ball tribometer to evaluate the wear and friction performance. Before testing the greases, they were stirred using a micro-spatula so as to ensure the consistency of the grease. The table 5.1 below gives a brief overview of the grease formulations and the additives used.

Table 5.1 Overview of grease formulation and additives used

Sl. No	Type of base grease	Additive used	Weight % of additive
Blend 1	Lithium 12 hydroxystearate (NLGI grade 2)	Techfine MoS ₂	3 wt.%
Blend 2	Lithium 12 hydroxystearate (NLGI grade 2)	ZDDP & PTFE	ZDDP : 3 wt.% PTFE : 2 wt.%

5.2.2 Four-ball Tribometer tests

The four ball wear tests were conducted in a continuous sliding mode under boundary lubrication regime. There were six different tests that were conducted which could be classified on the basis of the variables such as load and speed that were altered during the test. The tests wherein the load was varied keeping other variables fixed were termed as “Cyclic Loading” tests and when the speed was varied while maintaining all other variables constant were termed as “Cyclic Frequency” tests. The procedure for all the tests was in accordance to ASTM D2266 standards [1]. The ASTM method describes the test using three steel balls placed in a chuck that is locked using a cage and a fourth ball is rotated against the three stationary balls with the lubricating medium in between. This test is run at light loads so as to prevent any seizure or welding that would occur. The four balls are made up of E52100 steel (Bearing quality aircraft grade steel) & are ½” in diameter. The table 5.2 below gives the details of various test conditions that were used in the study.

Tests 1 to 4 are known as “Cyclic Loading” tests and the tests 5 & 6 are known as “Cyclic Frequency” tests. Tests 1, 2 and 5 can be categorized under “Ramp-down” tests

wherein the test begins at a higher load or frequency and terminates at a corresponding lower value. On similar basis Tests 3, 4 & 6 can be categorized under “Ramp-up” tests wherein the tests begin at a lower loads or frequency and terminate at a higher load or frequency.

Table 5.2 Overview of different test conditions used in the study

Test No.	Test Conditions	Type of Test	Constant Values	Graphical Representation
Test 1	80-40-80-40 (Kg)-15 min step	Ramp-down	1200 RPM, 75°C, 72000 cycles	
Test 2	80-40-80-40 (Kg)-7.5 min step	Ramp-down	1200 RPM, 75°C, 72000 cycles	
Test 3	40-80-40-80 (Kg)-15 min step	Ramp-up	1200 RPM, 75°C, 72000 cycles	
Test 4	40-80-40-80 (Kg)-7.5 min step	Ramp-up	1200 RPM, 75°C, 72000 cycles	
Test 5	1800-1200-600 (RPM) (13.3-20-40 (min))	Ramp-down	40 Kg, 75°C, 72000 cycles	
Test 6	600-1200-1800 (RPM) (40-20-13.3 (min))	Ramp-up	40 Kg, 75°C, 72000 cycles	

All the tests were run in duplicates to avoid any discrepancy in the data and had 72000 cycles maintained constant for each test. After the termination of every test, the three stationary steel balls were retrieved and analyzed to determine the WSD (Wear Scar Diameter). The tribofilm formed on the surface was analyzed and the wear mechanism was studied for each case.

5.2.3 Scanning Electron Microscopy (SEM) and Stereo-Optical Microscopy studies

Stereo-Optical microscope (model type: Nikon SMZ 1500) was used to image the wear scars formed on the three stationary steel balls after the four ball tests. The steel balls were cleaned using hexane and were mounted on a specially designed sample holder; which were then imaged at a magnification of 100X on the microscope. The images were analyzed using

the software provided by Quartz Imaging Corporation. The software comprised of functions like Micron-marker & Pixel-counter which was used to document the WSD for all the three steel balls and an average value was reported.

SEM (model type: Hitachi S-3000N) was used to in the SE (Secondary Electron) mode to image the wear surfaces at a higher magnification of upto 400X & an accelerating voltage of 15-20 kV was used in all the cases. Carbon tape was used to maintain good electrical contact in between the steel balls and sample holder. The wear mechanism in play on the surface as well as the tribofilm formed on the surface was evaluated. Specific areas on the surface which were of interest were imaged at a higher magnification to understand the wear mechanism.

5.3 Results

The following section discusses the results obtained from the Four-ball tribometer, the wear numbers and an in-depth analysis of the wear surface using the SEM. The effect of particle morphology on Spectrum loading conditions & synergism in between the additives is discussed & a correlation in between the two greases is established with the help of torque, friction coefficient and WSD.

5.3.1 SEM analysis of PTFE & MoS₂ particles

The SEM images were obtained for both MoS₂ & PTFE particles at magnifications of 500X & 1000X and 50X & 100X respectively, which correspond to the low and high magnification images at an acceleration voltage of 10 kV to 15 kV and a working distance of 14 mm to 15 mm.

The figure 5.1 compares the particle morphology of MoS₂ and PTFE. It can be clearly seen that the MoS₂ particles have sharp edges & corners whereas the PTFE particles are much smoother and have rounded edges. The presence of surface charging of PTFE particles makes them appear brighter even though imaged under similar conditions as MoS₂ particles. The problem of surface charging was tried to overcome by sputtering the PTFE particles with silver which made them more conductive; however the particle orientation would change in the SEM

exposing the uncoated surface that again led to surface charging leading to brighter images. From the results obtained, it is evident that MoS₂ particles behave more as an abrasive agent at lower loads as they are not easily sheared thereby depositing a film on the wear surface, whereas the irradiated PTFE particles have a carboxylic functionality which form polar end groups; these react with the freshly exposed wear surface protecting it from further wear and abrasion

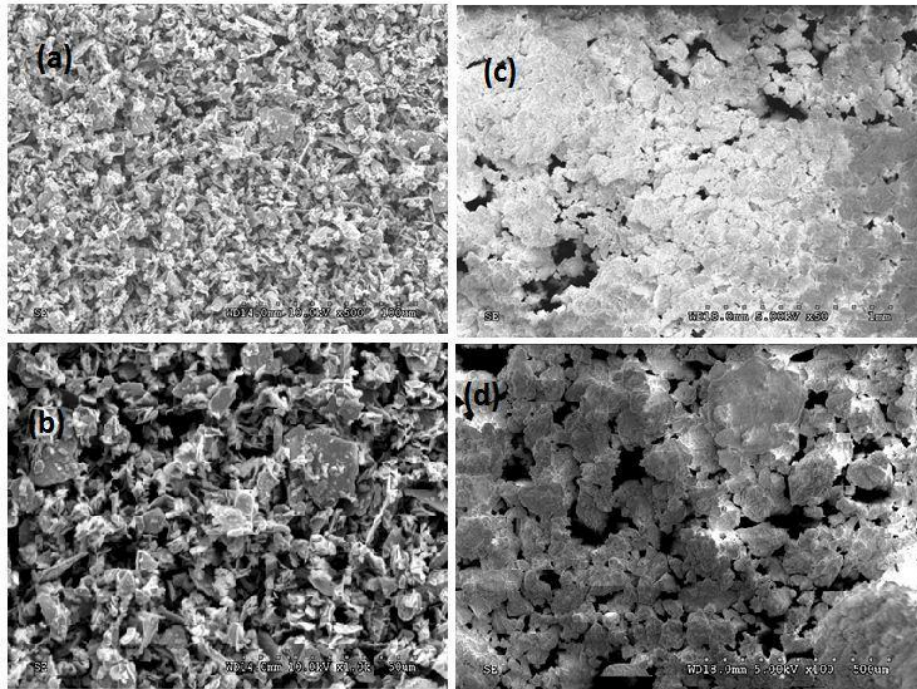

Fig 5.1 (a, b) SEM images of MoS₂ particles at 500X and 1000X;

(c, d) SEM images of PTFE particles at 50X and 100X

If the MoS₂ particles are not oriented in the direction of shearing, the sharp edges scrape through the wear surface abrading the metal thereby leading to an increased WSD and torque. Upon analysis of the WSD, torque & COF, it becomes quiet clear about the synergy in between the ZDDP & PTFE giving high performance grease as compared to the grease containing MoS₂ particles. The SEM analysis of the wear surface which will be presented in the

study also reveals that the surface is much smoother with less number of ploughing grooves & relatively less abrasive wear as compared to the surface obtained using the MoS₂ particles.

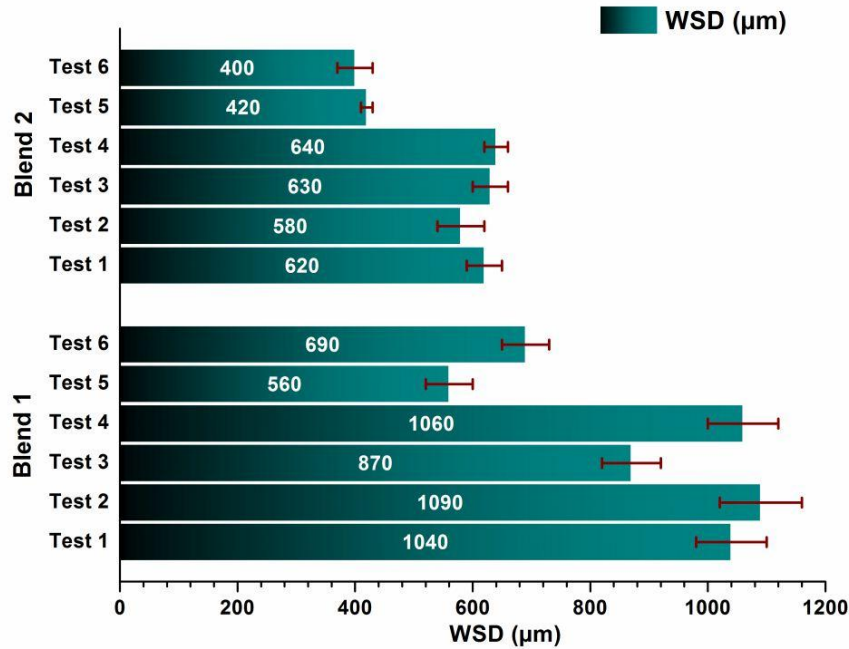

Fig 5.2 Wear Scar Diameters for Blend 1 and Blend

5.3.2 Analysis of Wear Scar Diameter (WSD)

The WSD was obtained for all the test balls using the method described in the section 5.2.3 and an average value was reported. The following figure 5.2 gives a representation of the wear numbers plotted in the form of a bar chart. Blend 1 corresponds to the grease blend formulated using MoS₂ particles and Blend 2 corresponds to the grease blend formulated using a combination of ZDDP & PTFE. The Test 1 to Test 6 represent different set of spectrum loading conditions as summarized in Table 5.2. All the values for the WSD are reported in μm with their exact values inset at the center of each bar. The error bars represent the corresponding variation in the WSD values for each test.

From the wear numbers it can be clearly seen that in every case the Blend 2 grease containing ZDDP & PTFE outperforms the Blend 1 grease containing MoS₂ particles. The wear

number distribution represented by the error bars is smaller for Blend 2 grease when compared with Blend 1 grease. Another observation that can be made is that the wear numbers for the cyclic frequency tests are lower than the wear number for cyclic loading tests for both the grease blends.

5.3.3 Torque and Coefficient of Friction (COF)

The torque and COF were obtained from the tests conducted using the Four-ball tribometer. Torque values are absolute whereas COF values are derived and hence were calculated using the procedure as described in ASTM D5183-05 standard [126]. Figures 5.3 to 5.5 represent the torque and COF values for both the blends used in the study and for all six tests. The load values plotted are in kilonewtons (kN), the frequency or the sliding speed values are in rotations per minute (rpm) and the torque values generated are in newton-meters (Nm). The figures 5.3 & 5.4 compare the torque and friction response of the greases under cyclic loading conditions wherein the loads are varied throughout the test while other parameters maintained constant, on the other hand figure 5.5 compares the torque and friction response of the greases under cyclic frequency conditions wherein the sliding speed is varied while maintaining other parameters constant.

Figure 5.3 compares the ramp-up and ramp-down conditions under cyclic loading regime which has a load step size of 15 minutes. The load & torque values are being plotted in kN and Nm respectively. Figure 5.3 (a, c) compare the torque responses for the Blend 1 & Blend 2 greases containing MoS₂ particles and a combination of ZDDP & PTFE respectively; whereas the figures 5.3 (b, d) compare the COF values of the blends for corresponding loading conditions. Figures 5.3 (a, b) correspond to Test 1 and the ramp-down conditions while figures 5.3 (c, d) correspond to Test 3 and the ramp-up conditions. These tests consist of 4 load steps of 15 minutes, each consisting of 18000 cycles that result in a total of 72000 cycles throughout the test. A clear observation that can be made from the torque & COF values in all the cases is

that the ZDDP/PTFE grease gives a much smoother variation in the torque and friction coefficient as well as lower absolute values when compared to the MoS₂ grease.

Figure 5.4 compares the ramp-up and ramp-down conditions under cyclic loading regime which has a load step size of 7.5 minutes. The load & torque values are plotted in the units of kN and Nm respectively. Figures 5.4 (a, c) compare the torque responses for the Blend 1 & Blend 2 greases and the figures 5.4 (b, d) compare the COF values of the blends for the corresponding loading conditions.

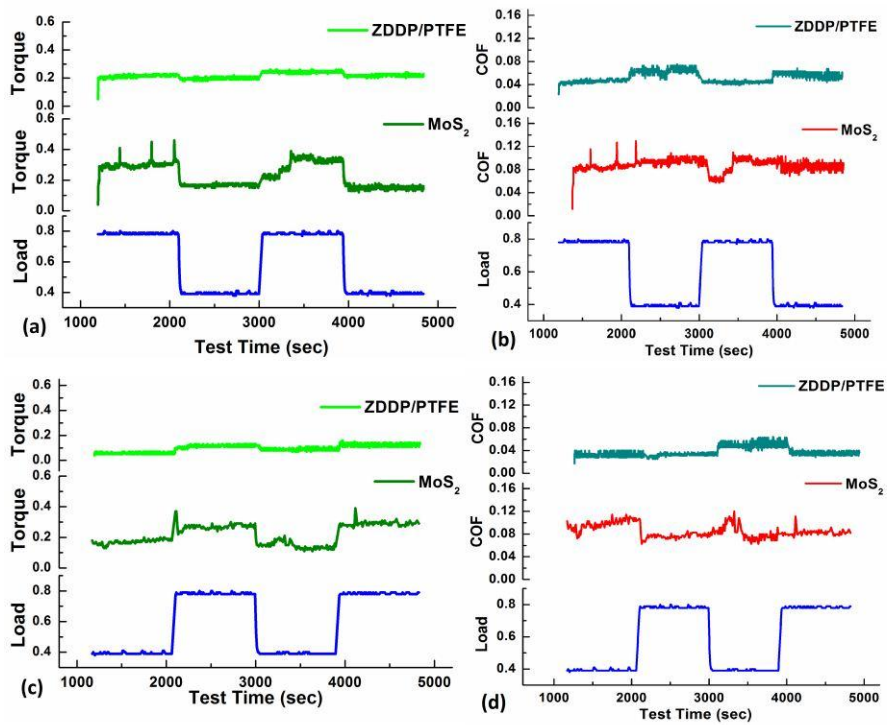

Figure 5.3 (a, c) Torque (Nm) and (b, d) COF values for cyclic loading conditions with a load step size of 15 minutes

Figures 5.4 (a, b) correspond to Test 2 and the ramp-down conditions while figures 4.4 (c, d) correspond to Test 4 and the ramp-up conditions. These tests consist of 8 load steps of 7.5 minutes, each consisting of 9000 cycles that result in a total of 72000 cycles throughout the test. When the torque and friction output obtained from tests with load step sizes of 7.5 min is

compared to the torque and friction output obtained from the tests with 15 min, it can be seen that larger the number of load variations the coarser is the corresponding output. In addition, the output obtained from MoS₂ grease has more excursions than the output obtained from ZDDP/PTFE grease which gives a much smoother outcome.

Figure 5.5 compares the ramp-up and ramp-down conditions under cyclic frequency regime which have a frequency step size of 600 rpm; under the ramp-down conditions the frequency or the sliding speed is decreased from 1800 rpm to 600 rpm in steps of 600 rpm whereas for ramp-up conditions the frequency or the sliding speed is increased from 600 rpm to 1800 rpm in steps of 600 rpm. The speed & torque values are plotted in the units of rpm and Nm respectively.

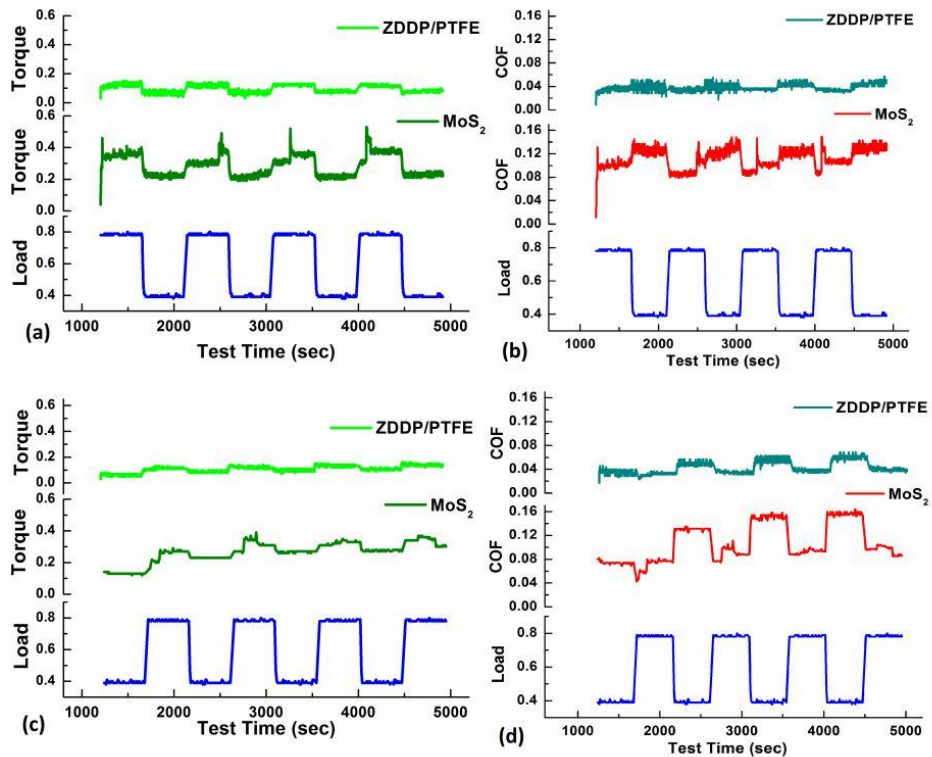

Figure 5.4 (a, c) Torque (Nm) and (b, d) COF values for cyclic loading conditions with a load step size of 7.5 minutes

Figure 5.5 (a, c) compare the torque responses for the Blend 1 & Blend 2 greases and the figures 5.5 (b, d) compare the COF values of the blends for the corresponding frequency conditions. Figures 5.5 (a, b) corresponds to Test 5 and the ramp-down conditions while figures 5.5 (c, d) correspond to Test 6 and the ramp-up conditions. These tests consist of 3 frequency steps, each consisting of 24000 cycles that result in a total of 72000 cycles throughout the test. The torque and COF variations in the case of cyclic frequency conditions are almost flat in both the blends. It is also observed that during the ramp-up tests at a frequency step of 1800 rpm, there is a slight drop in the COF for both the blends at higher rpm as the separation between the surfaces is increased reducing the asperity contacts thereby reducing the torque and friction coefficient.

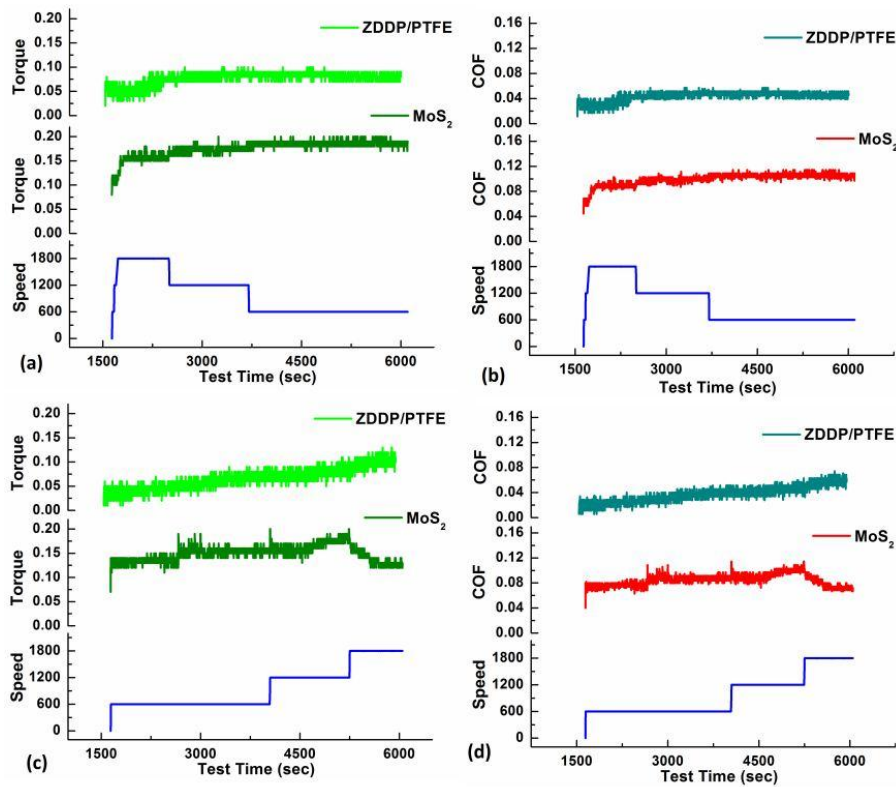

Figure 5.5 (a, c) Torque (Nm) and (b, d) COF values for cyclic frequency conditions with a frequency step size of 600 rpm

5.3.4 SEM analysis of the wear surface

The SEM images for the wear surfaces were obtained for all the tests and both the blends containing MoS₂ particles and a combination of ZDDP & PTFE. The images were taken at 80X and 400X which correspond to the lower and higher magnification at an acceleration voltage of around 20 kV and a working distance of 14 mm to 16 mm. Figures 5.6 & 5.7 compare the SEM images of MoS₂ grease at 80X and 400X while figures 5.8 & 5.9 compare the SEM images of the grease containing ZDDP & PTFE at 80X and 400X.

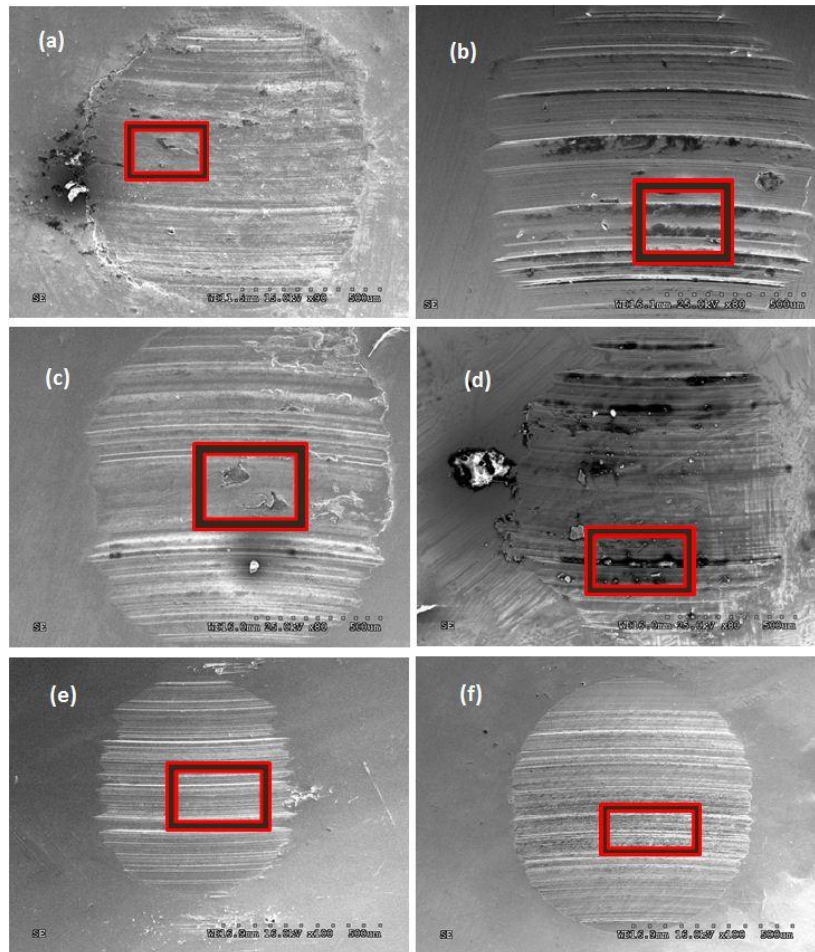

Figure 5.6 Low magnification SEM images for Blend 1 grease containing MoS₂ particles wherein (a to f) represent the images from Test 1 to Test 6

Figures 5.7 & 5.9 illustrate the representative areas shown enclosing the boxes shown in the figures 5.6 & 5.8; for all the test conditions the nature of wear mechanism and all the details pertaining to surface topography are explained. The scale for the SEM images is displayed using a micron marker.

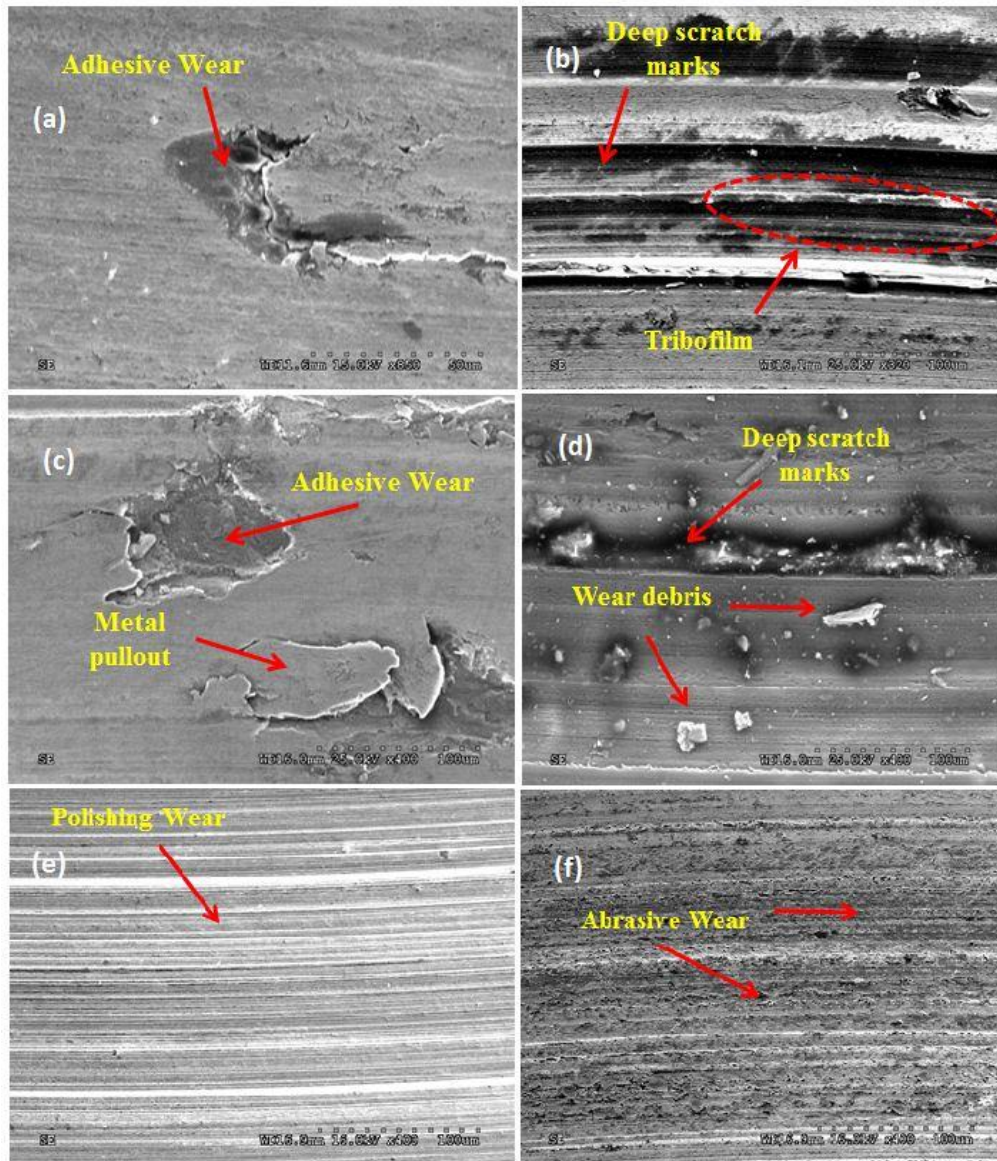

Figure 5.7 High magnification SEM images for Blend 1 grease containing MoS₂ particles wherein (a to f) represent the images from Test 1 to Test 6

Since all the images are taken under similar conditions it can be clearly seen that the cyclic loading tests have a larger WSD as compared to the cyclic frequency conditions.

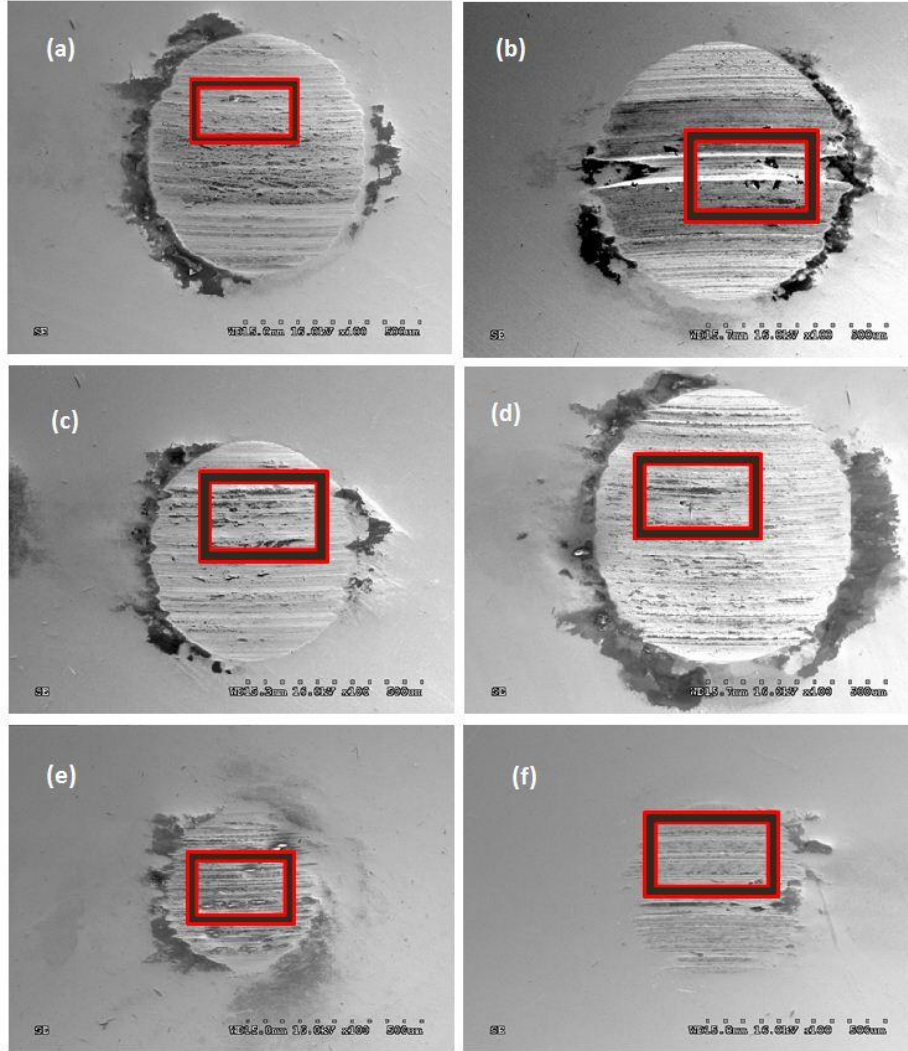

Figure 5.8 Low magnification SEM images for Blend 2 grease containing ZDDP & PTFE wherein (a to f) represent the images from Test 1 to Test 6

Figure 5.6 represents the low magnification SEM images for the wear surface obtained from Blend 1 grease containing MoS₂ particles at 80X. The representative boxes show the area of interest which is further magnified to study the wear mechanism. The images 5.6 (a-d) correspond to cyclic loading conditions and the images 5.6 (e & f) represent the cyclic frequency

conditions. Figure 5.7 represents the high magnification SEM images for the wear surface obtained from Blend 1 grease at 400X. These images represent the area enclosed in the boxes as shown in figure 5.6. A rough comparison in between the images taken at cyclic loading and cyclic frequency shows a large amount of wear for the cyclic loading tests as compared to the cyclic frequency tests. There is also a presence of excessive amount of abrasive wear and metal removal for cyclic loading tests as compared to the presence of polishing wear in the cyclic frequency tests.

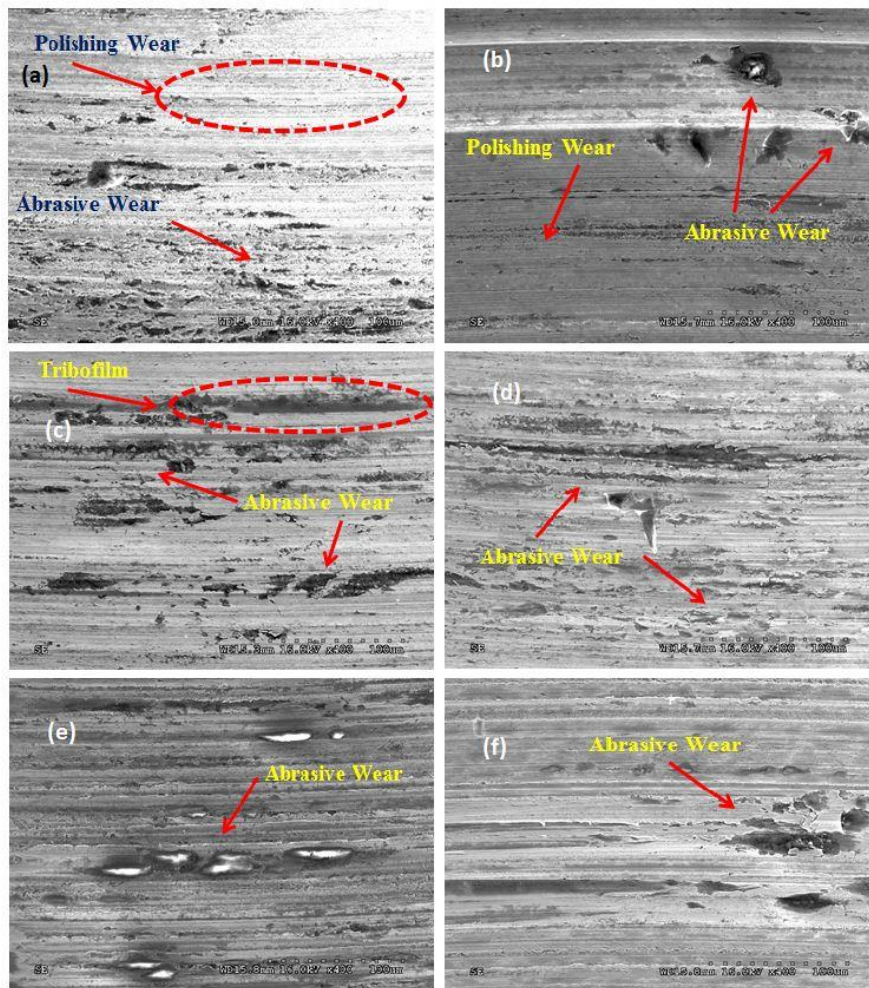

Figure 5.9 High magnification SEM images for Blend 2 grease containing ZDDP & PTFE wherein (a to f) represent the images from Test 1 to Test 6

The images 5.7 (a-d) correspond to cyclic loading conditions and the images 5.7 (e & f) represent the cyclic frequency conditions. A rough comparison in between the images for cyclic loading & cyclic frequency shows that a large amount of wear is present for the cyclic loading tests as compared to the cyclic frequency tests.

Figure 5.8 represents the low magnification SEM images for the wear surface obtained from Blend 2 grease containing a combination of ZDDP & PTFE at 80X. The representative boxes show the area of interest which is further magnified to study the wear mechanism. The images 5.8 (a-d) correspond to cyclic loading conditions and the images 5.8 (e & f) represent the cyclic frequency conditions. Analogous to figure 5.6 for Blend 1 grease, it is evident that the images for cyclic frequency conditions show smaller amount of wear & abrasion as compared to the cyclic loading conditions.

The SEM images in figure 5.9 represent the high magnification images of the Blend 2 grease containing ZDDP & PTFE. The images 5.9 (a-d) correspond to the cyclic loading conditions and the images 5.9 (e & f) represent the cyclic frequency conditions. Upon primitive observation of the images it can be identified that abrasive wear mechanisms, metal pull-out are dominant mechanisms in cyclic loading conditions whereas polishing wear seems to be evident in cyclic frequency conditions. There is also a presence of tribofilms on the wear surface that protects the surface from further wear and abrasion decreasing wear numbers.

5.4 Discussions

The following section discusses the effect of particle morphology and the synergy in between additive chemistries on the cyclic loading & cyclic frequency conditions. The wear mechanisms and the nature of tribofilms formed on the wear surface and its role in protecting the surface from further abrasion are discussed. A detailed account of the synergy in between the functionalized fluoropolymer and an organothiophosphate is discussed as well.

5.4.1 Effect of particle morphology

The SEM images shown in figure 5.1 compare the morphology of the MoS₂ and PTFE particles. The major difference that is clearly seen is the sharp edges and corners present on the MoS₂ particles and the curved or rounded edges on the PTFE particles. It has been proven in the previous studies [74,127], the abrasive nature of MoS₂ particles at lower loads was responsible for an increased wear and friction coefficient. It was also seen that increasing the amount of MoS₂ particles in the grease was responsible for a slight increase in the load bearing capacity; however it was responsible for increased wear and COF as well. If the high magnification images for these particles are compared as shown in figure 5.1 (b) & (d), shows striking difference in between the particles; MoS₂ particles which are not oriented in the direction of shearing in between the interacting surfaces, would scrape through the wear surface leading to abrasive wear, ploughing grooves and metal pull-out. A recent study by Suresh et al [2], has also established that a threshold amount of 3 wt. % of MoS₂ has to be used while formulating the greases so as to benefit from the EP properties; however the study also resulted an increased amount of wear upon increasing the MoS₂ content to 5 wt. %. At 5 wt. % the WSD was found to increase with a higher rpm and was independent of the test duration.

A primitive observation of the wear numbers as indicated in the figure 5.2 suggests that the Blend 2 grease containing ZDDP & PTFE yields lower wear numbers as compared to the Blend 1 grease containing MoS₂ particles. The corresponding error bars also represent lower variation in the distribution of WSD for Blend 2 grease and thereby proposing high repeatability. MoS₂ functions by shearing of the lamellar structure under applied loads; these layers get physically deposited on the wear surface forming a sacrificial tribofilm protecting the surface from wear and abrasion [115,121]. On the other hand if PTFE is used alone, a thin layer of PTFE adheres to the interacting surface due to a physical reaction in between the PTFE & metal substrate; PTFE chain might fracture under applied loads and temperatures inducing chemical reactions on the surface forming protective tribofilms [146]. PTFE also reacts

synergistically with ZDDP that helps improve the AW and EP properties. This synergism will be discussed in detail in the following section [149].

MoS₂ has long been used as an EP additive and is well known for its load bearing capabilities; the MoS₂ particles have to orient in the direction of shearing while passing through the interacting surfaces so that the layers get sheared which in-turn deposit on the surface forming a tribofilm that leads to an increase in the load bearing capability while protecting the surface from further abrasion [56,58,115,121]. Several studies have proposed different friction mechanisms for MoS₂ particles like intrinsic cleavage mechanism, adsorption mechanism theory and inter-crystallite slip mechanism which explain the effectiveness of MoS₂ as an EP additive [55,63,128]. If these particles have sharp edges and not oriented in the direction of shearing then it leads to an increased wear and friction.

5.4.2 Effect of cyclic loading conditions

In the current study an effort is made to understand the effects of varying loads & different step sizes on the wear and friction performance of the greases containing MoS₂ particles and a combination of ZDDP & PTFE. Cyclic loading conditions correspond to the Tests 1 to 4 and are further classified into ramp-up and ramp-down tests with load step sizes of 15 min and 7.5 min each. Tests 1 & 2 are ramp-down tests wherein the test begins at a higher load of 80 Kg and terminates at a lower load of 40 Kg, while Tests 3 & 4 are ramp-up tests wherein the test begins at a lower load of 40 Kg and terminates at a higher load of 80 Kg.

Figure 5.2 represents the WSD for Blend 1 and Blend 2 grease which corresponds to the grease containing MoS₂ particles and the grease containing ZDDP & PTFE. When the wear numbers for Tests 1 to 4 are compared for both the blends it can be clearly distinguished that the Blend 2 grease containing ZDDP & PTFE exhibits almost 30% to 40% less amount of wear as compared to the Blend 1 grease containing MoS₂ particles. When the tolerances for the wear numbers represented by the error bars is compared it can be seen that there is a wider distribution trend for the wear numbers obtained from the MoS₂ grease suggesting towards the

fact that the sharp edges and corners of the MoS₂ particles were responsible for large amount of abrasive wear and material removal; on the other hand the tolerances for the Blend 2 grease containing ZDDP & PTFE gives a narrower distribution trend and a correspondingly smaller WSD which was attributed to the synergistic interaction in between ZDDP & PTFE and presence of curved or rounded edges on the PTFE particles.

On comparison of the torque & coefficient of friction (COF) from figure 5.3 & figure 5.4 it can be seen that Blend 2 grease containing ZDDP & PTFE exhibit a very flat and a smoother trend of both the torque & COF as compared to Blend 1 grease containing MoS₂ particles. The sharp spikes that are visible in the torque and COF for all the tests of MoS₂ grease correspond to the tribological events like abrasive wear, adhesive wear, metal pull-out, deep scratch marks or ploughing grooves that occur on the wear surface during the test which leads to an increased load on the motor of the tribometer that is displayed as torque output; since COF is a quantity derived from the torque, the occurrences of the spikes in the COF curves correspond to the spikes in the torque output. Another trend that can be seen for the both the grease blends in all the tests is the presence of a small surge in the torque and COF values when the load is changed from 40 Kg to 80 Kg. This particular trend is much more visible for MoS₂ grease; since the torque values are very small for the Blend 2 grease this trend is not amplified in the output and is marginally visible as very small bumps. The MoS₂ particles present in between the interacting surfaces that are not oriented in the direction of shearing during an increase in the load from 40 Kg to 80 Kg tend to remove a larger amount of material than at lower loads. This material removal increases the load on the motor during an increase in the applied load leading to a number of spikes visible in the torque and COF output for Blend 1 grease containing MoS₂ particles at 80 Kg. However at an applied load of 40 Kg, there is a presence of much smoother bumps as compared to the existence of sharp spikes at 80 Kg.

It can also be seen that the torque and COF are inversely related for both the grease blends; upon increase in the load there is an increase in the torque and a corresponding

decrease in the COF values. It has been reported by several studies [2,58,67,69], that the lower loads are insufficient for shearing of MoS₂ particles thereby leading to an increase in the friction, however at higher loads the weak Van der Waals forces present in between the hexagonal Mo and S layers are overcome leading to shearing of the layers at the S-S interface. These layers physically deposit on the wear surface increasing the wear-load thereby preventing the seizure of the surfaces. Temperature and moisture also play a significant effect on the lubricating properties of MoS₂. The presence of moisture yields poor wear properties while its performance in dry air or in an inert environment containing argon gas gives a considerable improvement in its properties [129]. In a study on role of moisture on wear characteristics of MoS₂ by Gao et al [130] it has been shown that the presence of moisture leads to softening of MoS₂ particles resulting in a thinner film on the interacting surface thereby reducing its load bearing capabilities and exhibiting a poor wear performance.

On comparison of the tests in figures 5.3 and 5.4 with load steps of 15 min & 7.5 min respectively, it is observed that higher the number of changes in the load per test leads to an increased amount of wear and COF. When the WSD for the Tests 2 & 4 are compared with the WSD for Tests 1 & 3 as shown in figure 5.2, it suggests that the Tests 2 & 4 which have load step sizes of 7.5 min yield higher wear numbers. The cyclic loading tests with a load step size of 15 min exhibit a comparatively smoother distribution of torque and COF values as compared to the tests with load step size of 7.5 min. This is evidently seen for the Blend 1 grease, for the Blend 2 grease since there is a little variation in the torque for all the tests, there is no significant difference with respect to smoother distribution that is seen in the torque and COF curves for tests with step sizes of 15 min and 7.5 min. When ramp-up conditions are compared to ramp-down conditions for the Blend 1 grease, it is seen that ramp-up conditions exhibit a comparatively lower wear & COF values. For the Blend 1 grease containing MoS₂ particles, when figure 5.3 (c) is compared to figure 5.3 (a) and figure 5.4 (c) compared to figure 5.4 (a), it is evident that ramp-up conditions which begin at a lower load and terminate at a higher load

show a smoother variation in the torque and corresponding COF values; lower loads at a given sliding speed result in the formation of a stable tribofilm on the interacting surface which limits the abrasion of the surface when the load is ramped up. However in the case of ramp-down conditions where the tests begin at higher loads and terminate at lower loads, the MoS₂ particles which pass through the interacting surfaces in a manner that are not oriented in the direction of shearing, leads to an enormous amount of wear that increases the motor load leading to higher torque values and a coarse distribution of the torque. In the case of Blend 2 grease containing ZDDP/PTFE, there is no significant difference in the smoothness of the torque and COF curves for ramp-up tests; however for ramp-down tests that begin at a higher load and terminate at a lower load, the number of load change cycles influences the outcome of the torque. The ramp-down tests with load step size of 7.5 min would yield a coarser output as compared to the ramp-down tests with load step size of 15 min.

The average distribution of coefficient of friction values for Blend 1 grease containing MoS₂ particles & Blend 2 grease containing ZDDP & PTFE are 0.07 to 0.15 and 0.022 to 0.04 respectively. There is about 70% reduction in the COF values for Blend 2 grease with ZDDP/PTFE as compared to Blend 1 grease containing MoS₂ particles. This can be majorly attributed to the particle morphology, wherein most of the sharp edges and corners present on the MoS₂ particles are responsible for higher wear and friction as compared to the much smoother and rounded edges of PTFE particles combined with their synergy with ZDDP.

SEM images were taken at low and high magnification to understand the wear mechanism and surface topography that results after end of the tests. Figures 5.6 & 5.7 represent the low & high magnification SEM images for the Blend 1 grease containing MoS₂ particles while figures 5.8 & 5.9 represent the low & high magnification SEM images for the Blend 2 grease containing ZDDP & PTFE. A preliminary difference that is evident from figures 5.6 & 5.8 is that the wear scar diameter (WSD) for Blend 2 grease is much smaller than the WSD for Blend 1 grease in all the cases. The WSD results plotted in figure 5.2 suggests that for

Blend 2 grease, there is a drop in WSD values in the case of cyclic loading as well as cyclic frequency tests. This leads to one more observation that the particle morphology along with the additive synergy has a significant effect under spectrum loading conditions. Figures 5.7 & 5.9 show high magnification images for the two blends that represent the enclosed areas in the corresponding figures of 5.6 & 5.8; for Blend 1 grease, on comparison of figures 5.7 (a to d) which correspond to cyclic loading conditions, shows proof of rough surface with the presence of abrasive wear, adhesive wear, metal pull-out, deep grooves or scratch marks that is a result of MoS₂ particles which are known to be highly abrasive. Figure 5.7 (b & d) correspond to the Tests 2 & 4 that have a load step size of 7.5 min and leading to higher number of variations in the load which leads to a more coarse surface, higher torque and COF & a corresponding higher wear scar diameter as shown in figure 5.2. There is strong evidence of formation of tribofilm on the wear surface in figure 5.7 (b) which is beneficial in terms of increasing the load bearing capabilities. The presence of wear debris in figure 5.7 (d) shows signs of adhesive wear leading to cold weld of asperities on the wear surface. Figures 5.7 (a & c) represent Tests 1 & 3 which have load step size of 15 min; the wear surface shows abrasive wear accompanied by polishing wear. The Figure 5.9 (a to d) represent the cyclic loading conditions from Tests 1 to 4 for Blend 2 grease. There is no evidence showing ploughing grooves, deep scratch marks or adhesive wear on the wear track that is thought due to the formation of protective tribofilm on the wear surface due to the synergistic interaction in between ZDDP & PTFE. These sacrificial tribofilms are responsible for the reduction of WSD and COF. However there is a presence of abrasive wear & polishing wear on the interacting surfaces. Small patches of tribofilm are also formed on the surface.

5.4.3 Effect of cyclic frequency conditions

Cyclic frequency conditions correspond to the Tests 5 & 6 and can be further classified into ramp-down and ramp-up tests. These tests have a frequency step size of 600 rpm. Test 5 is a ramp-down test that begins at 1800 rpm and terminates at 600 rpm while Test 6 is a ramp-

up test that begins at 600 rpm and terminates at 1800 rpm. Figure 5.2 represents that WSD for both the grease blends. On comparing the WSD for Tests 5 & 6, a difference of about 150 μm to 250 μm is seen in the WSD for the Blend 1 & Blend 2 grease containing MoS_2 & ZDDP/PTFE. The wear number distribution which is represented by the error bars for tests 5 and 6 shows minimal variation for the Blend 2 grease suggesting highly repeatable results and lower variation in the distribution of WSD.

Figure 5.5 gives a plot of the torque and COF values for the ramp-up and ramp-down tests. A primary observation of these graphs reveals that at 1800 rpm the torque and COF values significantly drop for all the cases of Blend 1 grease; at higher rpm and constant loads the smaller MoS_2 particles would be responsible for the load bearing capability of the grease as they can enter interacting surfaces without much resistance at high grease flow rates, however larger particles have a lower probability of entering the space in between the interacting surfaces and are thought to freely circulate in the medium with less contribution towards the EP effects of the grease. The number of smaller MoS_2 particles is significantly less as compared to the larger particles; since the number of abrasive particles that interact with the surface in the case of Blend 1 grease is less, it results in a lower WSD and less wear on the surface as compared to the cyclic loading tests, it is evident from the figure 5.2 that presents the wear numbers. The COF values significantly drop as they are derived from the load and torque. In the case of Blend 2 grease containing ZDDP & PTFE, there is a drop in the torque and COF values at higher rpm in ramp-down tests; however in ramp-up tests as shown in figure 5.5 (c & d), it is seen that the torque and COF values increase with an increase in the rpm.

It is well known from the principles of boundary lubrication and the stribeck curve that with an increase in the sliding speed of the surfaces or an increase in the fluid viscosity the separation in between the opposing surfaces is increased resulting in a mixed or a hydrodynamic lubrication regime depending on the thickness of the lubricant layer which is present in between the interacting surfaces. When the separation in between the surfaces is

more than the height of asperities, it leads to a significant drop in the COF and wear of the surfaces as the asperities no longer touch each other which might have led to an abrasive or adhesive wear and the formation of wear debris that would increase the WSD [17,24,131-133]. During the ramp-down tests as indicated in the figure 5.5 (a & b), it can be seen that the torque and COF values in the beginning of the tests are lower when the sliding speed is 1800rpm and slowly rise or are constant towards the end of the test when the sliding speed is 600 rpm. With a reduction in the sliding speed the surfaces come closer to each other increasing the likelihood of asperity contact resulting in wear of the surface. During the ramp-up tests as shown in figure 5.5 (c & d), it is observed that at 1800 rpm there is a sharp decrease in the torque and COF values for the Blend 1 grease as the lubrication regime enters the mixed or hydrodynamic lubrication regime reducing the asperity contact that leads to a reduction in the wear and a reduced motor load which is displayed as a sharp plunge in the torque and COF values.

Comparison of the SEM images of the wear track for the grease containing MoS₂ & ZDDP/PTFE shows minimal signs of abrasive or adhesive wear and very less number of ploughing grooves. Figure 5.6 (e & f) as well as figure 5.8 (e & f) represent low magnification images for Blend 1 and Blend 2 grease respectively; the WSD obtained for Blend 2 grease is slightly lower than the WSD for Blend 1 grease. Figure 5.7 (e & f) and figure 5.9 (e & f) show the high magnification SEM images of the wear surface that represent the areas enclosed in the corresponding low magnification SEM images in figures 5.6 and 5.8. The topography of the wear surface shows prominent presence of polishing wear with little evidence of severe wear phenomenon occurring on the surface. The sharp edges and particles of MoS₂ present in the Blend 1 grease contribute to abrasive wear in certain areas as shown in figure 5.7 (f), for Blend 2 grease containing ZDDP/PTFE, there is evidence of minor abrasive wear and tribofilm formation on the surface in the form of patches that protects the surface from further abrasion & wear.

5.4.4 Synergism in between ZDDP and PTFE

In the current study a functionalized fluoropolymer like PTFE that has a carboxylic functionality was used with an organothiophosphate like ZDDP to understand their behavior under spectrum loading conditions. There are a number of studies that suggest synergism in between ZDDP and PTFE. The fluoropolymer is surrounded by carboxylic acid functional groups which makes it more active when interacting with an organothiophosphate [2]. ZDDP functions as an AW additive by forming glassy tribofilm that is made up of short chain and long chain polyphosphates along with sulfides of Fe, Zn. The hard glassy films are formed when degradation compounds from tribochemical break-down of ZDDP react with the wear surface [150,151]. In some of the recent studies using ZDDP and a fluorinated compound usually a metal halide like FeF_3 , it was shown that the fluorinated compounds which act as fluorinating agents were able react with ZDDP leading to formation of a fluorinated version of ZDDP which was more reactive and effective as an antiwear agent [75,80,152,153]. In some of the recent studies, it has been shown that the decomposition temperature of ZDDP decreases in the presence of irradiated PTFE and metal halides like FeF_3 . Differential scanning calorimeter study was done on the combinations of ZDDP/PTFE and ZDDP/PTFE/ FeF_3 ; it was observed that, in the first embodiment comprising of ZDDP/PTFE the ZDDP decomposes at 166°C that is approximately 15°C below its usual decomposition temperature and with the second embodiment consisting ZDDP/PTFE/ FeF_3 the ZDDP decomposes at 155°C that is about 26°C below the usual decomposition temperature. In the DSC plots an extra endotherm present at 170°C in the first embodiment where ZDDP/PTFE were used, suggests the formation of a new reaction product in the presence of a functionalized fluoropolymer that is beneficial in forming protective tribofilms. In the current study it is highly possible that the functionalized fluoropolymer being very reactive forms a complex with the organothiophosphate thereby increasing its likelihood of deposition on the tribological surface reducing the extent of wear and increasing the load bearing capability. It was also suggested that the reaction mixture consisting of ZDDP/PTFE

can be either reacted in or outside the lubricant environment and during or before the test [149,154,155]. The PTFE used in the present study contained about 40 to 6000 carbon atoms. The particle size of PTFE is very crucial in deciding the functionality and its degradation impacts the tribological properties of fluoropolymer. Irradiation leads to creation of electron acceptor groups on the PTFE particles which are necessarily dangling bonds thereby enhancing its adhesion to the surface. PTFE particles form a lubricious coating on the wear surface under temperature and pressure forming a tribofilm, makes PTFE prone to fracture and very brittle. Furthermore, the synergistic interaction of functionalized PTFE and ZDDP leads to a formation of a complex molecule on the reaction surface that comprises of ZDDP and its degradation products becoming a part of the fluoropolymer thereby having AW, EP and anti-friction properties on the same molecule [154].

5.5 Conclusions

The current study was focused on developing & testing of high performance greases with optimum AW/EP properties under spectrum loading conditions. The research emphasizes on developing new greases with higher AW/EP capabilities without MoS₂ particles. Some of the conclusions drawn are:

1. Due to the morphology of the MoS₂ particles, they behave as a pro-abrasive agent at lower loads which are not sufficient to overcome Van der Waals forces present at the S-S layer interface in the MoS₂ structure that is responsible for shearing of lamellar layers forming a tribofilm on the wear surface.
2. The morphology of the MoS₂ & PTFE particles has a significant effect on the wear and frictional performance of the formulated greases under spectrum loading conditions. PTFE particles owing to their rounded and curved edges combined with their synergy with ZDDP yield much lower wear numbers and COF values when compared to the grease containing MoS₂ particles.

3. Under cyclic loading conditions where the sliding speed or the rpm of the opposing surfaces is fixed, higher the number of load changes leads to relatively higher wear and abrasion of the surface. The results obtained for tests with load steps of 7.5 minutes exhibit higher amount of wear and COF as compared to the tests with load steps of 15 minutes.
4. Cyclic frequency conditions where loads are maintained constant do not show a significant change in the wear & friction data for both the Blend 1 & Blend 2 grease containing MoS₂ particles and ZDDP/PTFE under ramp-up and ramp-down conditions respectively; however for Blend 1 grease at higher frequencies, the lubricating regime slowly changes to mixed lubrication or hydrodynamic lubrication regime increasing the separation of opposing surfaces reducing the asperity interaction leading to a decrease in the wear & COF values.
5. Under cyclic loading conditions for Blend 1 grease, the ramp down tests exhibit relatively higher wear and COF values as compared to the ramp-up tests; a protective tribofilm is formed on the wear surface initially at lower loads in the ramp-up tests that protects the wear surface from wear and abrasion at higher loads. For Blend 2 grease there is no significant variation in the wear and COF values obtained for ramp-up and ramp-down tests.
6. Superior AW/EP performance of the Blend 2 grease is attributed to the synergistic interaction in between a fluoropolymer like PTFE that is functionalized with an organothiophosphate like ZDDP. The fluoropolymer acts as a fluorinating agent thereby reducing the decomposition temperature of ZDDP as well as create additional decomposition products that form a protective tribofilm on the wear surface leading to an increase in the anti-wear as well as load bearing capabilities.

CHAPTER 6

ROLE OF FRICTION MODIFIERS ON FRICTION AND WEAR PERFORMANCE OF GREASES UNDER SPECTRUM LOADING CONDITIONS

This chapter discusses the test results obtained from the two greases blended using a combination of ZDDP/PTFE and ZDDP/PTFE/MoDTC; an in-depth analysis of the wear surface and the wear mechanism is presented. This chapter compares the torque and friction coefficient values obtained from the four-ball experiments. A correlation of the synergy in between ZDDP & PTFE in reducing the wear numbers as well as coefficient of friction is established. The effect of MoDTC in reducing the friction coefficient as well as a synergy in between ZDDP & MoDTC is evaluated. An effort is also made to understand the mechanism of formation of tribofilms from the additive chemistries & their AW/EP properties.

Four-ball tests were carried out for screening of AW/EP properties of the greases and the WSD (Wear Scar Diameter) for the steel balls obtained from Four-ball tests is determined. A brief description of different characterization techniques like SEM (Scanning Electron Microscopy), Stereo-optical microscope which were used to analyze the wear mechanism, tribofilms and the wear surface are discussed as well.

6.1 Introduction

One of the most effective ways to increase the efficiency of the machines is by reducing the wear and abrasion that occurs at the interfaces; avoiding frictional heating and material removal using lubricants leads to lower consumption of hydrocarbons and a greener environment. Greases are semisolid lubricants which are commonly used in automotive, industrial and aerospace applications. The thickeners in the grease give it enhanced load bearing capability as compared to lubricating oils. A number of additives such as ZDDP, PTFE,

MoDTC, MoS₂ and graphite are added to the base grease to impart AW/EP and anti-friction properties [26,134-136].

ZDDP has been used as an anti-wear (AW) additive in greases and oils since a long time. ZDDP undergoes tribochemical decomposition under heat and pressure; the decomposition products include long and short chain polyphosphates along with sulfides of Fe & Zn that react with the wear surface forming hard and glassy tribofilms protecting the surface from further wear and abrasion. ZDDP are very useful under boundary lubrication regime and are known for its mild anti-oxidation properties. ZDDP was used extensively in the past due to the ease of manufacturing & lower costs, however recent emission standards limit the amount of P & S that is contained in ZDDP which has led to a research for new alternatives [82,142,156-158]. In some of the recent studies which used ZDDP and a fluorinated compound usually a metal halide like FeF₃, it was observed that the fluorinated compounds which act as fluorinating agents were able to react with ZDDP leading to the formation of a fluorinated version of ZDDP which was more reactive and effective as an antiwear agent. The fluorinated ZDDP formed thicker tribofilms and NMR spectroscopy revealed the existence of P-F bonds as a result of direct interaction between ZDDP and metal halides [75,80,152,153,159]. A study by Aswath et al [149,154,155], showed that a combination of a functionalized fluoropolymer like PTFE with an organothiophosphate like ZDDP yielded a high performance lubricant additive that had excellent anti-wear, anti-friction and load bearing capabilities which could be used for crankcase oils, transmission oils, gear oils and greases. A study by Suresh et al [2] and Munot et al [127] reported exceptional load bearing capabilities and low wear and friction of the interacting surface when a combination of ZDDP & PTFE was used. In the current study it is highly possible that the functionalized fluoropolymer being very reactive forms a complex with the organothiophosphate thereby increasing its likelihood of deposition on the tribological surface reducing the extent of wear and increasing the load bearing capability.

MoDTC (Molybdenum Dithiocarbamate) is a well-known friction modifier that has been used in the lubricants for quite some time; they fall under the category of Organomolybdenum compounds. The friction reduction under boundary lubrication regime is attributed to the formation of MoS₂ on the wear surface at the asperity contact [160-163]; MoS₂ is a solid lubricant that has a hexagonal lamellar crystal structure, wherein the layers slide on top of each other under loads leading to a reduction in the friction coefficient [137-141]. In some of the recent studies, it has been shown that ZDDP is synergistic with MoDTC in reducing the wear and friction. It was also found out that the issue of insolubility of MoDTC in the lubricants could be overcome by mixing them with the organothiophosphate; ZDDP was found to enhance the formation of MoS₂ on the wear surface leading to a lower friction [95,164-167]. Though a number of techniques like XPS, TEM and Raman spectroscopy have been used the exact mechanism of MoS₂ formation from MoDTC is yet to be understood [97,163].

In the current study two different grease formulations are prepared in Lithium-base greases and are tested in a Four-ball tribometer in accordance to ASTM D2266 standard. There were a total of six different test conditions studied wherein the load and the frequency or the speed are varied independent of each other in a cyclic manner to evaluate the effect of load and frequency on the wear scar formed on ½” steel balls made of E52100 grade steel. It was also made sure that when one of the test parameter was varied, rest of the parameters was held constant as prescribed in the ASTM standard. The cyclic loading tests were categorized under Ramp-up & Ramp-down conditions wherein the tests were started with initial load of 40Kg and were terminated at a final load of 80 Kg and vice versa. These tests were further classified on the basis of load step sizes of 7.5 min and 15 min each. The rpm and test temperature were maintained at 1200 rpm and 75°C. The cyclic frequency tests were classified as Ramp-up and Ramp-down conditions wherein the frequency was varied from 600 rpm to 1800 rpm in steps of 600 rpm and vice versa. The load and test temperature were maintained at 40 Kg and 75°C. The two different additives chosen for the study were: first one is a combination of ZDDP/PTFE

and the second grease blend being a combination of ZDDP/PTFE/MoDTC. The formulations were made in Lithium-base grease. The grease containing MoS₂ particles had a treat level of 3 wt. % and the grease containing ZDDP & PTFE had treat levels of 3 wt. % and 2 wt. % respectively.

The total number of cycles subjected in each test was for all the six different test conditions were held constant at 72000 cycles. Duplicates of the test were run to confirm the wear numbers and the average values obtained from both the tests were reported. The WSD (Wear Scar Diameter) was calculated for each test. The torque and the friction coefficient values obtained from the Four-ball machine are plotted and reported in the following study. The tribofilm formed on the wear surface was evaluated using SEM (Scanning Electron Microscopy), Stereo-optical microscope and EDS (Energy Dispersive Spectroscopy). The type of wear mechanism in play was studied for each case. Since the actual applications require bearings to be subjected to varying conditions of load and frequency, the main objective of this research is to determine the wear performance of greases under spectrum loading conditions rather than testing it under the ASTM standards wherein the test parameters are held constant throughout the test.

6.2 Experimental procedure

6.2.1 Additive Chemistries and Formulation of Greases

A total of two grease blends were prepared in batches of approximately 200 grams. The Lithium-base grease used in the study was Texaco Marfak Multipurpose grease. It had a NLGI grade of 2 and had a dropping point of 188°C. The thickener type used was lithium 12-hydroxystearate. The grease had a kinematic viscosity of 220 cSt at 40°C. The color & texture were buttery & brown. The kitchen aid blender was used for blending and had a power rating of 250 W and a capacity of 1 gallon.

- i. The first grease blend was prepared using a mixture of functionalized PTFE (Poly tetrafluorethylene) and ZDDP (Zinc dialkyl dithiophosphate). In general PTFE is a well-

known anti-friction additive and ZDDP has been used since a long time as an anti-wear additive for engine oils and other lubricants. It was particularly interesting to formulate grease with these additives as they are known to be synergistic and to test their performance under spectrum loading conditions. About 3 wt. % of ZDDP & 2 wt. % of PTFE was used in Lithium base grease and the mixture was blend in a kitchen aid blender for about 2 hours. After an interval of 15 to 20 min, the blender was stopped and a spatula was used to manually mix the content in the steel bowl of the blender which ensured homogeneity and adequate blending of the grease.

- ii. The second grease blend consisted of functionalized PTFE, ZDDP and MoDTC (Molybdenum Dithiocarbamate) in a ratio of 3:2:2 wt. %. This grease blend was tested so as to study the effect friction modifiers on the grease that contains a mixture of PTFE & ZDDP. The MoDTC used was supplied by RT Vanderbilt under the commercial name Molyvan[®] A [116]. The three additives were first taken in the steel bowl of the kitchen aid and stirred manually with a spatula so that the PTFE gets functionalized with the dithiophosphate and dithiocarbamate functional groups. The Li-base grease is then added to this mixture and stirred in the kitchen aid for 2 hours in a similar manner.

The blended greases were tested in a four ball tribometer to evaluate the wear and friction performance. Before testing the greases, they were stirred using a micro-spatula so as to ensure the consistency of the grease. The table 6.1 below gives a brief overview of the grease formulations and the additives used.

6.2.2 Four-ball Tribometer tests

The four ball wear tests were conducted in a continuous sliding mode under boundary lubrication regime. There were six different tests that were conducted which could be classified on the basis of the variables such as load and speed that were altered during the test. The tests wherein the load was varied keeping other variables fixed were termed as “Cyclic Loading” tests

and when the speed was varied while maintaining all other variables constant were termed as “Cyclic Frequency” tests.

Table 6.1 Overview of grease formulation and additives used

Sl. No	Type of base grease	Additive used	Weight % of additive
Blend 1	Lithium 12 hydroxystearate (NLGI grade 2)	ZDDP & PTFE	ZDDP : 3 wt.% PTFE : 2 wt.%
Blend 2	Lithium 12 hydroxystearate (NLGI grade 2)	ZDDP, PTFE & MoDTC	ZDDP : 3 wt.% PTFE : 2 wt.% MoDTC : 2 wt.%





The procedure for all the tests was in accordance to ASTM D2266 standards [1]. The ASTM method describes the test using three steel balls placed in a chuck that is locked using a cage and a fourth ball is rotated against the three stationary balls with the lubricating medium in between. This test is run at light loads so as to prevent any seizure or welding that would occur. The four balls are made up of E52100 steel (Bearing quality aircraft grade steel) & are ½” in diameter. The table 6.2 below gives the details of various test conditions that were used in the study.

Tests 1 to 4 are known as “Cyclic Loading” tests and the tests 5 & 6 are known as “Cyclic Frequency” tests. Tests 1, 2 and 5 can be categorized under “Ramp-down” tests wherein the test begins at a higher load or frequency and terminates at a corresponding lower value. On similar basis Tests 3, 4 & 6 can be categorized under “Ramp-up” tests wherein the tests begin at a lower loads or frequency and terminate at a higher load or frequency. All the tests were run in duplicates to avoid any discrepancy in the data and had 72000 cycles maintained constant for each test. After the termination of every test, the three stationary steel balls were retrieved and analyzed to determine the WSD (Wear Scar Diameter). The tribofilm formed on the surface was analyzed and the wear mechanism was studied for each case.

6.2.3 Scanning Electron Microscopy (SEM) and Stereo-Optical Microscopy studies

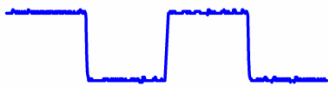
Stereo-Optical microscope (model type: Nikon SMZ 1500) was used to image the wear scars formed on the three stationary steel balls after the four ball tests. The steel balls were cleaned using hexane and were mounted on a specially designed sample holder; which were then imaged at a magnification of 100X on the microscope. The images were analyzed using the software provided by Quartz Imaging Corporation. The software comprised of functions like Micron-marker & Pixel-counter which was used to document the WSD for all the three steel balls and an average value was reported.

Table 6.2 Overview of different test conditions used in the study

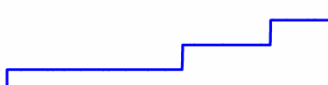
Test No.	Test Conditions	Type of Test	Constant Values	Graphical Representation
Test 1	80-40-80-40 (Kg)-15 min step	Ramp-down	1200 RPM, 75°C, 72000 cycles	
Test 2	80-40-80-40 (Kg)-7.5 min step	Ramp-down	1200 RPM, 75°C, 72000 cycles	
Test 3	40-80-40-80 (Kg)-15 min step	Ramp-up	1200 RPM, 75°C, 72000 cycles	
Test 4	40-80-40-80 (Kg)-7.5 min step	Ramp-up	1200 RPM, 75°C, 72000 cycles	
Test 5	1800-1200-600 (RPM) (13.3-20-40 (min))	Ramp-down	40 Kg, 75°C, 72000 cycles	
Test 6	600-1200-1800 (RPM) (40-20-13.3 (min))	Ramp-up	40 Kg, 75°C, 72000 cycles	

SEM (model type: Hitachi S-3000N) was used to in the SE (Secondary Electron) mode to image the wear surfaces at a higher magnification of upto 400X & an accelerating voltage of 15-20 kV was used in all the cases. Carbon tape was used to maintain good electrical contact in between the steel balls and sample holder. The wear mechanism in play on the surface as well

as the tribofilm formed on the surface was evaluated. Specific areas on the surface which were of interest were imaged at a higher magnification to understand the wear mechanism.

6.3 Results

The following section discusses the results obtained from the Four-ball tribometer, the wear numbers and an in-depth analysis of the wear surface using the SEM. The effect of friction modifiers on Spectrum loading conditions & synergism in between the additives is discussed & a correlation in between the two greases is established with the help of torque, friction coefficient and WSD.

6.3.1 Analysis of Wear Scar Diameter (WSD)

The WSD was obtained for all the test balls using the method described in the section 6.2.3 and an average value was reported. The following figure 6.1 gives a representation of the wear numbers plotted in the form of a bar chart. Blend 1 corresponds to the grease blend formulated using a combination of ZDDP & PTFE and the Blend 2 corresponds to the grease blend formulated using a combination of ZDDP, PTFE & MoDTC. The Test 1 to Test 6 represent different set of spectrum loading conditions as summarized in Table 6.2.

All the values for the WSD are reported in μm with their exact values inset at the center of each bar. The error bars represent the corresponding variation in the WSD values for each test. From the wear numbers it can be clearly seen that in every case the Blend 2 grease containing ZDDP/PTFE/MoDTC outperforms the Blend 1 grease containing ZDDP/PTFE. The wear number distribution is represented by the error bars in every case.

6.3.2 Torque and Coefficient of Friction (COF)

The torque and COF were obtained from the tests conducted using the Four-ball tribometer. Torque values are absolute whereas COF values are derived and hence were calculated using the procedure as described in ASTM D5183-05 standard [126]. Figures 6.2 to 6.4 represent the torque and COF values for both the blends used in the study and for all six tests.

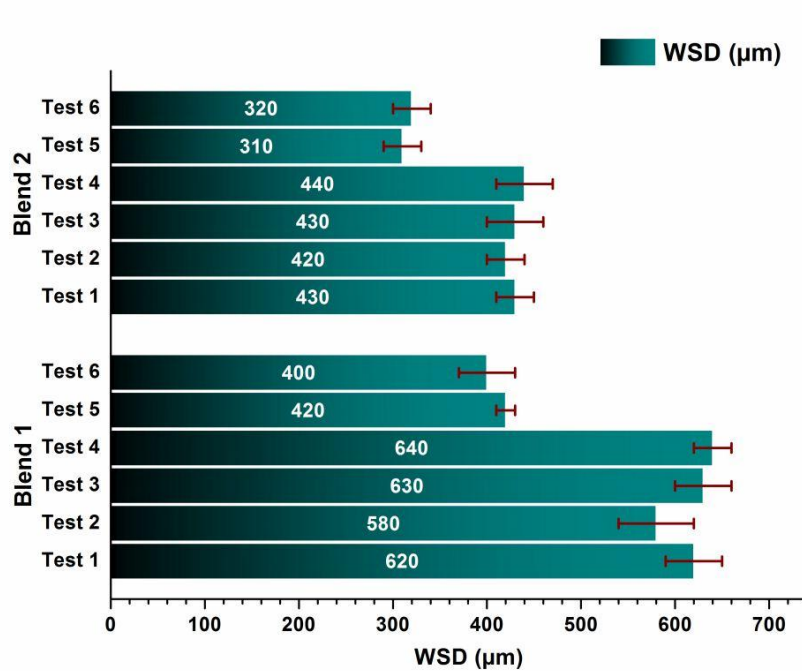

Fig 6.1 Wear Scar Diameters for Blend 1 and Blend

The load values plotted are in kilonewtons (kN), the frequency or the sliding speed values are in rotations per minute (rpm) and the torque values generated are in newton-meters (Nm). The figures 6.2 & 6.3 compare the torque and friction response of the greases under cyclic loading conditions wherein the loads are varied throughout the test while other parameters maintained constant, on the other hand figure 6.4 compares the torque and friction response of the greases under cyclic frequency conditions wherein the sliding speed is varied while maintaining other parameters constant.

Figure 6.2 compares the ramp-up and ramp-down conditions under cyclic loading regime which has a load step size of 15 minutes. The load & torque values are being plotted in kN and Nm respectively. Figure 6.2 (a, c) compare the torque responses for the Blend 1 & Blend 2 greases containing a combination of ZDDP/PTFE and ZDDP/PTFE/MoDTC respectively; whereas the figures 6.2 (b, d) compare the COF values of the blends for corresponding loading conditions. Figures 6.2 (a, b) correspond to Test 1 and the ramp-down

conditions while figures 6.2 (c, d) correspond to Test 3 and the ramp-up conditions. These tests consist of 4 load steps of 15 minutes, each consisting of 18000 cycles that result in a total of 72000 cycles throughout the test.

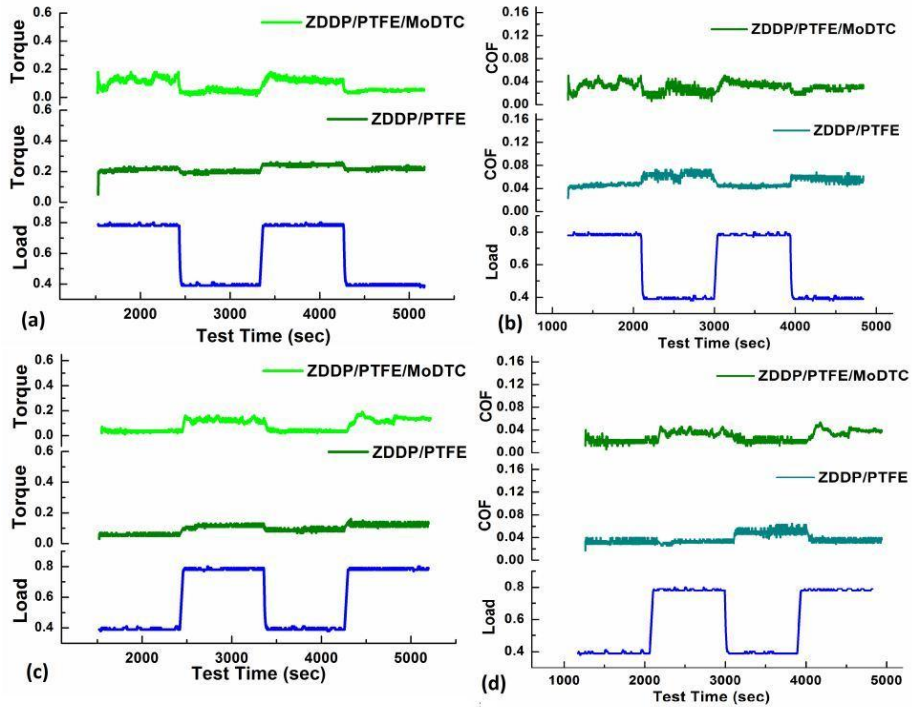

Figure 6.2 (a, c) Torque (Nm) and (b, d) COF values for cyclic loading conditions with a load step size of 15 minutes

A clear observation that can be made from the torque & COF values in all the cases is that the ZDDP/PTFE grease gives smoother variation in the torque and friction coefficient when compared to the ZDDP/PTFE/MoDTC grease. MoDTC forms thin layers of in-situ MoS₂ films that slide over each other reducing the friction in between interacting surfaces. This is a continuous process wherein the MoS₂ films are generated and removed; the COF is lower when the film is in place and gradually goes up when the layers are removed and then reformed again. This leads to a coarser output in the torque and COF values.

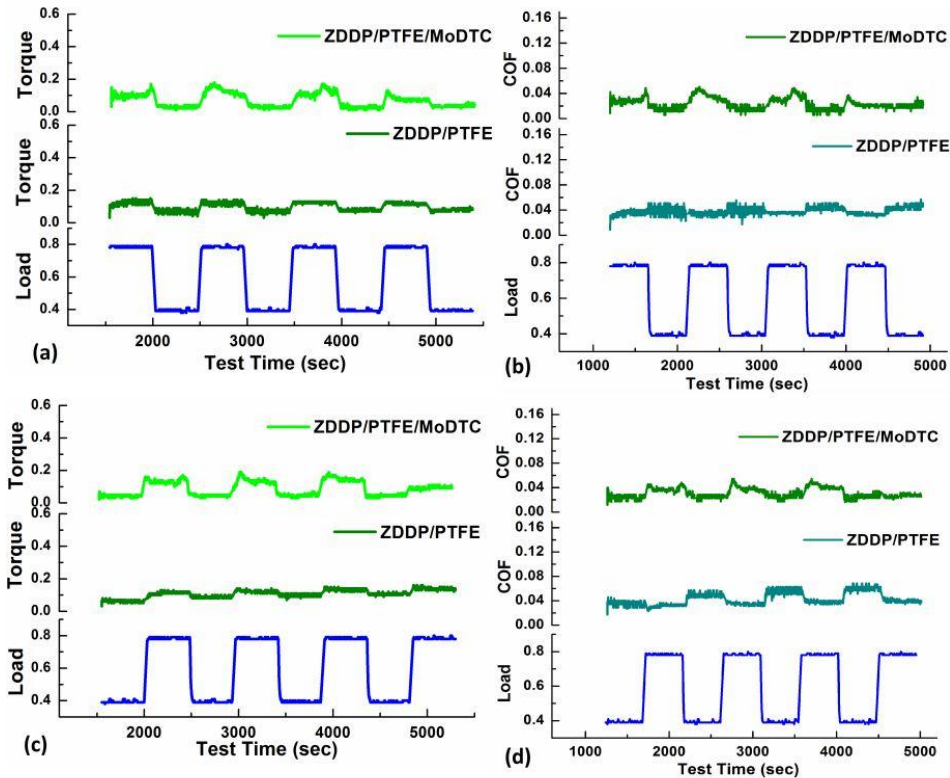

Figure 6.3 (a, c) Torque (Nm) and (b, d) COF values for cyclic loading conditions with a load step size of 7.5 minutes

Figure 6.3 compares the ramp-up and ramp-down conditions under cyclic loading regime which has a load step size of 7.5 minutes. The load & torque values are plotted in the units of kN and Nm respectively. Figures 6.3 (a, c) compare the torque responses for the Blend 1 & Blend 2 greases and the figures 6.3 (b, d) compare the COF values of the blends for the corresponding loading conditions. Figures 6.3 (a, b) correspond to Test 2 and the ramp-down conditions while figures 6.3 (c, d) correspond to Test 4 and the ramp-up conditions. These tests consist of 8 load steps of 7.5 minutes, each consisting of 9000 cycles that result in a total of 72000 cycles throughout the test. When the torque and friction output obtained from tests with load step sizes of 7.5 min is compared to the torque and friction output obtained from the tests with 15 min, it can be seen that larger the number of load variations the coarser is the

corresponding output. In addition, the output obtained from ZDDP/PTFE/MoDTC grease has more excursions than the output obtained from ZDDP/PTFE grease which gives a much smoother outcome.

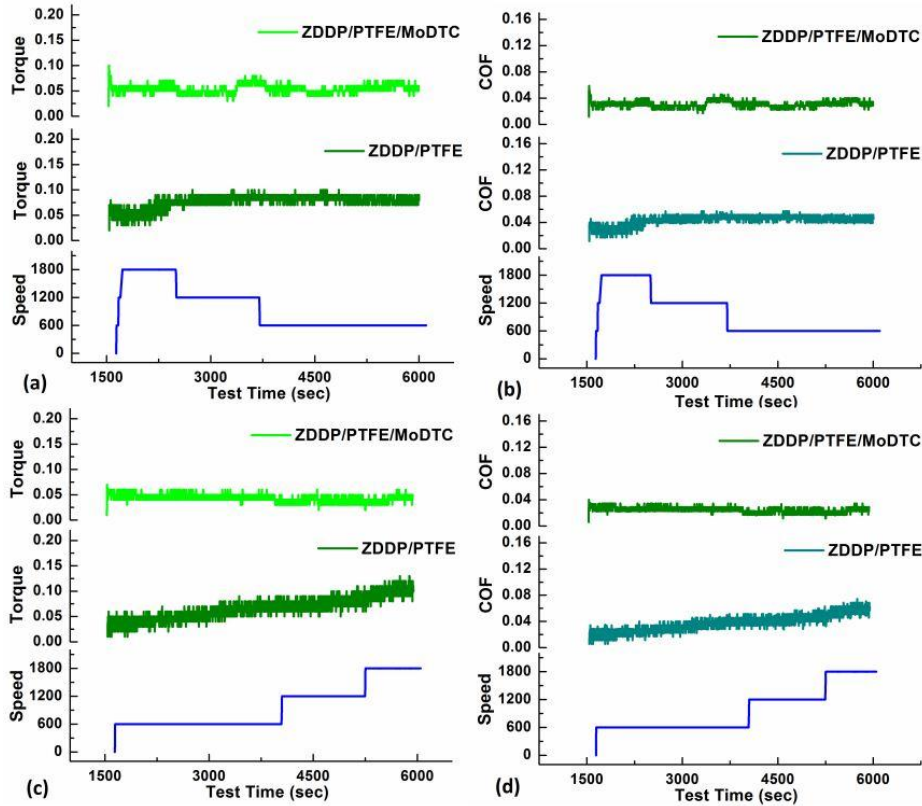

Figure 6.4 (a, c) Torque (Nm) and (b, d) COF values for cyclic frequency conditions with a frequency step size of 600 rpm

Figure 6.4 compares the ramp-up and ramp-down conditions under cyclic frequency regime which have a frequency step size of 600 rpm; under the ramp-down conditions the frequency or the sliding speed is decreased from 1800 rpm to 600 rpm in steps of 600 rpm whereas for the ramp-up conditions the frequency or the sliding speed is increased from 600 rpm to 1800 rpm in steps of 600 rpm. The speed & torque values are plotted in the units of rpm and Nm respectively. Figure 6.4 (a, c) compare the torque responses for the Blend 1 & Blend 2 greases and the figures 6.4 (b, d) compare the COF values of the blends for the corresponding

frequency conditions. Figures 6.4 (a, b) corresponds to Test 5 and the ramp-down conditions while figures 6.4 (c, d) correspond to Test 6 and the ramp-up conditions. These tests consist of 3 frequency steps, each consisting of 24000 cycles that result in a total of 72000 cycles throughout the test. The torque and COF variations in the case of cyclic frequency conditions are almost flat in both the blends. It is also observed that during the ramp-up tests at a frequency step of 1800 rpm, there is a slight drop in the COF for the ZDDP/PTFE grease due to the fact that at higher rpm as the separation between the surfaces is increased reducing the asperity contacts thereby reducing the torque and friction coefficient.

6.3.3 SEM analysis of the Wear surface

The SEM images for the wear surfaces were obtained for all the tests and both the blends containing a combination of ZDDP/PTFE and ZDDP/PTFE/MoDTC. The images were taken at 80X and 400X which correspond to the lower and higher magnification at an acceleration voltage of around 20 kV and a working distance of 14 mm to 16 mm. Figures 6.5 & 6.6 compare the SEM images of Blend 1 grease at 100X and 400X while figures 6.7 & 6.8 compare the SEM images of the Blend 2 grease at 100X and 400X. Figures 6.6 & 6.8 illustrate the representative areas shown enclosing the boxes shown in the figures 6.5 & 6.7; for all the test conditions the nature of wear mechanism and all the details pertaining to surface topography are explained. The scale for the SEM images is displayed using a micron marker.

Figure 6.5 represents the low magnification SEM images for the wear surface obtained from Blend 1 grease containing ZDDP/PTFE at 100X. The representative boxes show the area of interest which is further magnified to study the wear mechanism. The images 6.5 (a-d) correspond to cyclic loading conditions and the images 6.5 (e & f) represent the cyclic frequency conditions. Since all the images are taken under similar conditions it can be clearly seen that the cyclic loading tests have a larger WSD as compared to the cyclic frequency conditions.

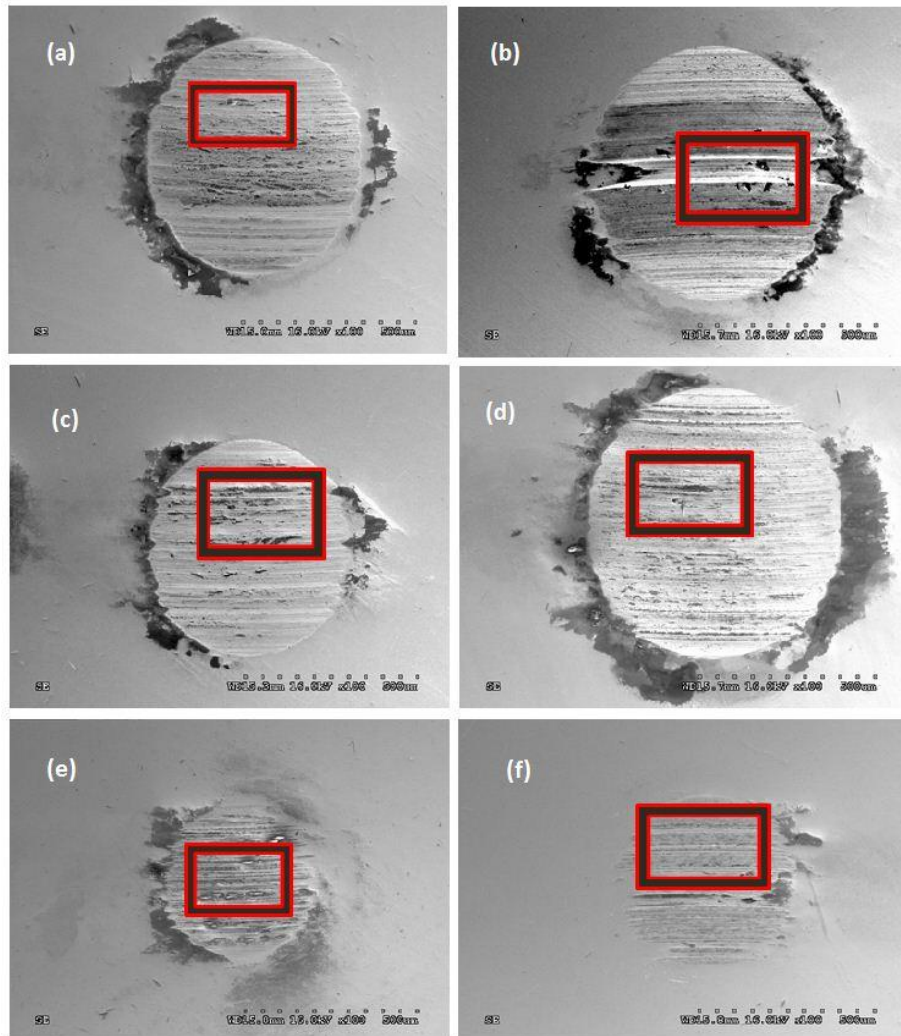

Figure 6.5 Low magnification SEM images for Blend 1 grease containing ZDDP/PTFE wherein (a to f) represent the images from Test 1 to Test 6

Figure 6.6 represents the high magnification SEM images for the wear surface obtained from Blend 1 grease at 400X. These images represent the area enclosed in the boxes as shown in figure 6.5. The images 6.6 (a-d) correspond to cyclic loading conditions and the images 6.6 (e & f) represent the cyclic frequency conditions. A rough comparison in between the images taken at cyclic loading and cyclic frequency shows a large amount of abrasive wear for the cyclic loading tests as compared to the cyclic frequency tests. There is also a presence of polishing

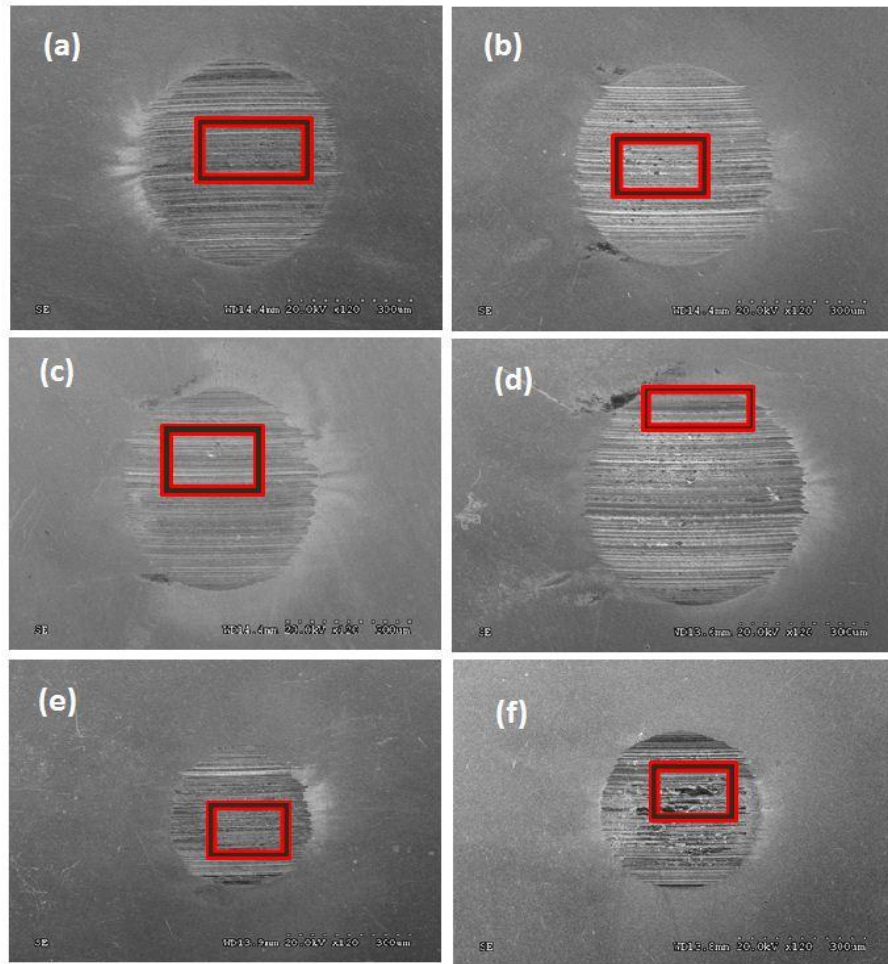

Figure 6.7 Low magnification SEM images for Blend 2 grease containing ZDDP/PTFE/MoDTC wherein (a to f) represent the images from Test 1 to Test 6

The SEM images 6.8 show represent the high magnification images of the Blend 2 grease containing ZDDP/PTFE/MoDTC. The images 6.8 (a-d) correspond to the cyclic loading conditions and the images 6.8 (e & f) represent the cyclic frequency conditions. Upon close observation of the images it can be identified that abrasive & adhesive wear mechanisms are dominant mechanisms in cyclic loading conditions whereas polishing wear seems to be evident in cyclic frequency conditions. There is also strong evidence suggesting the formation of tribofilm on the wear surface in both cyclic loading and cyclic frequency conditions that is

beneficial in terms of increasing the load bearing capability and reducing the wear on the interacting surfaces.

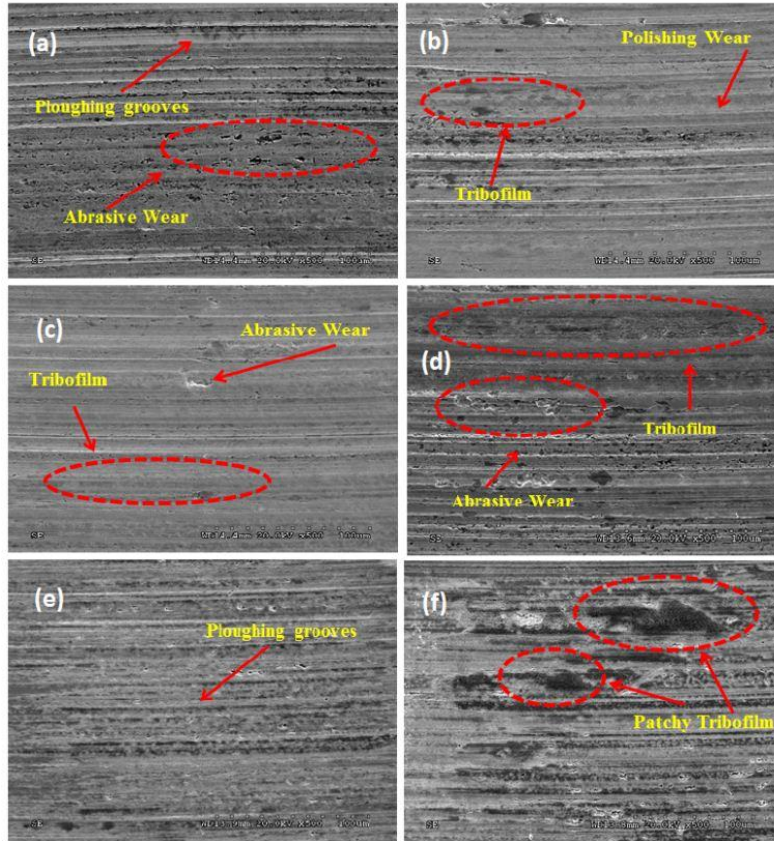

Figure 6.8 High magnification SEM images for Blend 2 grease containing ZDDP/PTFE/MoDTC wherein (a to f) represent the images from Test 1 to Test 6

6.4 Discussions

The following section discusses the effect of friction modifier and the synergy in between additive chemistries on the cyclic loading & cyclic frequency conditions. The wear mechanisms and the nature of tribofilms formed on the wear surface and its role in protecting the surface from further abrasion are discussed. A correlation in between the greases is established with the help of high magnification SEM images, torque, friction coefficient and WSD. A detailed account of the synergy in between the functionalized fluoropolymer (PTFE),

organomolybdenum compounds (MoDTC) and an organothiophosphate (ZDDP) is discussed as well.

6.4.1 Effect of cyclic loading conditions

In the current study an effort is made to understand the effects of varying loads & different step sizes on the wear and friction performance of the greases containing a combination of ZDDP/PTFE and ZDDP/PTFE/MoDTC. Cyclic loading conditions correspond to the Tests 1 to 4 and are further classified into ramp-up and ramp-down tests with load step sizes of 15 min and 7.5 min each. Tests 1 & 2 are ramp-down tests wherein the test begins at a higher load of 80 Kg and terminates at a lower load of 40 Kg, while Tests 3 & 4 are ramp-up tests wherein the test begins at a lower load of 40 Kg and terminates at a higher load of 80 Kg.

Figure 6.1 represents the WSD for Blend 1 and Blend 2 grease which corresponds to the grease containing a combination of ZDDP/PTFE and the grease containing ZDDP/PTFE/MoDTC. When the wear numbers for Tests 1 to 4 are compared for both the blends it can be clearly distinguished that the Blend 2 grease containing ZDDP/PTFE/MoDTC exhibits almost 30% to 35% less amount of wear as compared to the Blend 1 grease containing ZDDP/PTFE. When the tolerances for the wear numbers represented by the error bars are compared it can be seen that there is no major differences in the distribution trend for the wear numbers obtained from the both the blends. It is known that there is a synergism in between ZDDP/PTFE as well as ZDDP/MoDTC [2,97,149,160].

On comparison of the torque & coefficient of friction (COF) from figure 6.2 & figure 6.3 it can be seen that Blend 1 grease containing ZDDP/PTFE exhibits a comparatively flat and a smoother trend in both the torque & COF as compared to Blend 2 grease containing ZDDP/PTFE/MoDTC. The coarse variations that are seen in the torque and COF for all the tests of Blend 2 grease corresponds to the formation and removal of MoS₂ films on the wear surface during the test. MoDTC forms in-situ MoS₂ films in the presence of high temperatures and pressures at the contact points which leads to a reduced COF, however when these films are

removed from the wear surface it leads to an increase COF and wear. Since this process of generation and removal continues through the test, it leads to a coarser output in the COF and torque when compared to the ZDDP/PTFE grease. Another trend that can be seen for the both the grease blends in all the tests is the presence of a small surges in the COF values when the load is changed from 40 Kg to 80 Kg. This particular trend is much more visible for the ZDDP/PTFE/MoDTC grease; since the torque values are very small for both the grease blends this trend is not amplified in the output and is marginally visible as very small bumps.

It can also be seen that the torque and COF are inversely proportional for the ZDDP/PTFE grease and directly proportional for the ZDDP/PTFE/MoDTC grease. This type of behavior can be attributed to the changes in the torque. In the case of ZDDP/PTFE/MoDTC grease, the increase in the torque is not proportional to an increase in the load when load is changed from 40 Kg to 80 Kg resulting in an increase in the COF and vice-versa. However in the case of ZDDP/PTFE grease an increase in the torque is proportional to an increase in the load when the load is changed from 40 Kg to 80 Kg leading to a decrease in the COF. The MoS₂ layers that are formed in-situ are transfer films that lead to an increase in the weld-load thereby preventing the seizure of the surfaces.

On comparison of the tests in figures 6.2 and 6.3 with load steps of 15 min & 7.5 min respectively, it is observed that larger the number of changes in the load per test leads to an increased amount of wear and COF. When the WSD for the Tests 2 & 4 are compared with the WSD for Tests 1 & 3 as shown in figure 6.1, it suggests that the Tests 2 & 4 which have load step sizes of 7.5 min yield a comparatively higher wear numbers. The cyclic loading tests with a load step size of 15 min exhibit a comparatively smoother distribution of torque and COF values as compared to the tests with load step size of 7.5 min.

This is evidently seen for the for Blend 2 grease, for the Blend 1 grease since there is a little variation in the torque for all the tests and no significant difference with respect to smoother distribution seen in the torque and COF curves for tests with step sizes of 15 min and 7.5 min.

When the wear numbers for ramp-up conditions are compared to ramp-down conditions for both the grease blends, it is seen there is no significant difference between the two conditions.

For the Blend 2 grease containing ZDDP/PTFE/MoDTC, when figure 6.2 (c) is compared to figure 6.2 (a) and figure 6.3 (c) compared to figure 6.3 (a), it is evident that ramp-up conditions which begin at a lower load and terminate at a higher load show a comparatively smoother variation in the torque and corresponding COF values; lower loads at a given sliding speed result in the formation of a stable tribofilm on the interacting surface which limits the abrasion of the surface when the load is ramped up. However in the case of ramp-down conditions where the tests begin at higher loads and terminate at lower loads, it can be seen that the torque and COF distribution is coarse. In the case of Blend 1 grease containing ZDDP/PTFE, there is no significant difference in the smoothness of the torque and COF curves for ramp-up tests; however for ramp-down tests that begin at a higher load and terminate at a lower load, the number of load change cycles influences the outcome of the torque. The ramp-down tests with load step size of 7.5 min would yield a comparatively coarser output as compared to the ramp-down tests with load step size of 15 min.

The average distribution of coefficient of friction values for Blend 1 grease containing ZDDP/PTFE & Blend 2 grease containing ZDDP/PTFE/MoDTC is 0.02 to 0.038 and 0.022 to 0.045 and respectively. There is about 20% reduction in the COF values for Blend 2 grease with ZDDP/PTFE/MoDTC as compared to Blend 1 grease containing ZDDP/PTFE. This can be majorly attributed to the in-situ MoS₂ formation wherein the sliding of these layers results in a smooth and lubricious surface.

SEM images were taken at low and high magnification to understand the wear mechanism and surface topography that results after end of the tests. Figures 6.5 & 6.6 represent the low & high magnification SEM images for the Blend 1 grease containing ZDDP/PTFE while figures 6.7 & 6.8 represent the low & high magnification SEM images for the Blend 2 grease containing ZDDP/PTFE/MoDTC. A preliminary difference that is evident from

figures 6.5 & 6.7 is that the wear scar diameter (WSD) for Blend 2 grease is smaller than the WSD for Blend 1 grease in all the cases. The WSD results plotted in figure 6.1 suggests that for Blend 2 grease, there is a drop in WSD values in the case of cyclic loading as well as cyclic frequency tests. This leads to one more observation that the in-situ tribochemical reactions combined with the additive synergies has a significant effect under spectrum loading conditions. Figures 6.6 & 6.8 show high magnification images for the two blends that represent the enclosed areas in the corresponding figures of 6.5 & 6.7; for Blend 1 grease, on comparison of figures 6.6 (a to d) which correspond to cyclic loading conditions, shows evidence of abrasive wear, polishing wear & tribofilm formation thought due to the synergistic interaction in between ZDDP & PTFE. Figure 6.6 (b & d) correspond to the Tests 2 & 4 that have a load step size of 7.5 min and leading to larger number of variations in the load which leads to a more coarse surface, higher torque and COF & a comparatively higher wear scar diameter as shown in figure 6.1. There is strong evidence of formation of tribofilm on the wear surface in figure 6.6 (c) which is beneficial in terms of increasing the load bearing capabilities. There is a presence of material removal as shown in the figure 6.6 (b & f). Figures 6.6 (a & c) represent Tests 1 & 3 which have load step size of 15 min; the wear surface shows signs of abrasive wear accompanied by polishing wear. The figure 6.8 (a to d) represent the cyclic loading conditions from Tests 1 to 4 for Blend 2 grease. There is evidence showing a relatively small number of ploughing grooves, deep scratch marks & abrasive wear on the wear track accompanied by the formation of tribofilms. These sacrificial tribofilms are responsible for the reduction of WSD and COF which are formed due to the synergism in between ZDDP/PTFE and ZDDP/MoDTC.

6.4.2 Effect of cyclic frequency conditions

Cyclic frequency conditions correspond to the Tests 5 & 6 and can be further classified into ramp-down and ramp-up tests. These tests have a frequency step size of 600 rpm. Test 5 is a ramp-down test that begins at 1800 rpm and terminates at 600 rpm while Test 6 is a ramp-up test that begins at 600 rpm and terminates at 1800 rpm. Figure 6.1 represents that WSD for

both the grease blends. On comparing the WSD for Tests 5 & 6, a difference of about 100 μm to 120 μm is seen in the WSD for the Blend 1 & Blend 2 grease containing ZDDP/PTFE & ZDDP/PTFE/MoDTC. The wear number distribution which is represented by the error bars for tests 5 and 6 shows minimal variation for both the grease blends suggesting highly repeatable results and lower variation in the distribution of WSD.

Figure 6.4 gives a plot of the torque and COF values for the ramp-up and ramp-down tests. A primary observation of these graphs reveals at higher rpm and constant loads the COF values are smaller. In the case of Blend 1 grease containing ZDDP/PTFE, there is a drop in the torque and COF values at higher rpm in ramp-down tests; however in ramp-up tests as shown in figure 6.4 (c & d), it is seen that the torque and COF values increase with an increase in the rpm.

It is well known from the principles of boundary lubrication and the stribeck curve that with an increase in the sliding speed of the surfaces or an increase in the fluid viscosity, the separation in between the opposing surfaces is increased resulting in a mixed or a hydrodynamic lubrication regime depending on the thickness of the lubricant layer which is present in between the interacting surfaces. When the separation in between the surfaces is more than the height of asperities, it leads to a significant drop in the COF and wear of the surfaces as the asperities no longer touch each other which might have led to an abrasive or adhesive wear and the formation of wear debris that would increase the WSD [17,24,131-133]. During the ramp-down tests as indicated in the figure 6.4 (a & b), it can be seen that the torque and COF values in the beginning of the tests are lower when the sliding speed is 1800rpm and slowly rise or are constant towards the end of the test when the sliding speed is 600 rpm. With a reduction in the sliding speed the surfaces come closer to each other increasing the likelihood of asperity contact resulting in wear of the surface. During the ramp-up tests as shown in figure 6.4 (c & d), it is observed that at 1800 rpm there is a slight decrease in the torque and COF values for the Blend 2 grease as the lubrication regime enters the mixed or hydrodynamic

lubrication regime reducing the asperity contact that leads to a reduction in the wear and a reduced motor load which is displayed as a sharp plunge in the torque and COF values.

Comparison of the SEM images of the wear track for the grease containing ZDDP/PTFE and ZDDP/PTFE/MoDTC shows minimal signs of abrasive and very less number of ploughing grooves along with signs of tribofilm formation. Figure 6.5 (e & f) as well as figure 6.7 (e & f) represent low magnification images for Blend 1 and Blend 2 grease respectively; the WSD obtained for Blend 2 grease is slightly lower than the WSD for Blend 1 grease. Figure 6.6 (e & f) and figure 6.8 (e & f) show the high magnification SEM images of the wear surface that represent the areas enclosed in the corresponding low magnification SEM images in figures 6.5 and 6.7. The topography of the wear surface shows prominent presence of polishing wear & tribofilm formation with little evidence of severe wear phenomenon occurring on the surface. In the case of Blend 2 grease containing ZDDP/PTFE/MoDTC, there is evidence of minor abrasive wear and tribofilm formation on the surface in the form of patches that protects the surface from further abrasion & wear.

6.4.3 Synergism in between additive chemistries

It has been well established that synergism exists in between ZDDP/PTFE and ZDDP/MoDTC. In the current study a functionalized fluoropolymer like PTFE that has a carboxylic functionality was used with an organothiophosphate like ZDDP to understand their behavior under spectrum loading conditions. The fluoropolymer is known to reduce the decomposition temperature of ZDDP as well as help in formation of new reaction products that are beneficial in forming protective tribofilms [2]. The fluoropolymer forms a complex with the organothiophosphate thereby increasing its likelihood of deposition on the tribological surface reducing the extent of wear and increasing the load bearing capability [149,154,155]. The functionalized PTFE used in the present study contained about 40 to 6000 carbon atoms. The particle size of PTFE is very crucial in deciding the functionality and its degradation impacts the tribological properties of fluoropolymer. Irradiation leads to creation of electron acceptor groups

on the PTFE particles which are necessarily dangling bonds thereby making them polar and enhancing their surface affinity. PTFE particles form a lubricious coating on the wear surface under temperature and pressure forming a tribofilm. Furthermore, the synergistic interaction of functionalized PTFE and ZDDP leads to a formation of a complex molecule on the reaction surface that comprises of ZDDP and its degradation products becoming a part of the fluoropolymer thereby having AW, EP and anti-friction properties on the same molecule [154].

The synergism in between ZDDP/MoDTC is also well established wherein ZDDP is known to enhance the degradation of MoDTC to form lubricious MoS_2 films on the wear surface which result in a low friction. It has also been reported that ZDDP modifies the friction and wear performance of MoDTC [95,97,166]. A study by Muraki et al [164,165] reported that there is a competitive reaction in between phosphorous compounds and organo-molybdenum compounds occurring at the wear surface under rolling-sliding conditions. They also reported that under constant sliding conditions with an increase in the sliding speed and surface temperature, there was a reduction in the coefficient of friction. They also reported that with time, the MoS_2 concentration on the surface steadily increased forming protective tribofilms on the surface. There was no significant change in the surface roughness of the samples before and after the test. They reported that the MoDTC is first adsorbed and decomposed in the tribological contact regions owing to high temperature and pressure forming lubricious MoS_2 films. Some of the XPS studies that were done of the tribological surface showed the presence of MoS_2 along with small quantities of molybdenum oxide & metal sulfides and phosphates. It is also reported that the antioxidation properties of ZDDP which acts as a secondary anti-oxidant helps in reduction of molybdenum oxide formation thereby eliminating the abrasive decomposition products from wear surface giving a smoother tribofilm and lower friction coefficient [97,168,169].

MoDTC when used by itself is known to form MoS_2 along with MoO_3 and sulfides of iron. Since MoS_2 is a well-known lamellar solid lubricant known to give low friction and wear numbers, MoDTC is very effective when used in lubricating oils and greases. In a study by

Grossiord et al [163], the degradation pathway of MoDTC in tribological contacts has been reported. They proposed the MoDTC degradation in two-steps: the initial step being an electron transfer occurring on the Mo-S bond leading to three free radicals that lead to the formation of thiuram-disulfide, MoS₂ and MoO₂. MoO₂ oxidizes further to form MoO₃ which is abrasive and may lead to a higher wear number. MoS₂ crystalizes into sheets that forms lubricious film on the surface. TEM analysis of the wear debris also gave evidence of single sheet MoS₂ that was responsible for lower friction. The study also suggests the adhesion of the MoS₂ sheets on the counterface by transfer films.

6.5 Conclusions

The current study was focused on developing & testing of high performance greases with optimum AW/EP properties under spectrum loading conditions. The research emphasizes on developing new greases with higher AW/EP capabilities without MoS₂ particles and evaluates the effect of friction modifiers on the wear and friction performance under spectrum loading conditions. Some of the conclusions drawn from the study are:

1. ZDDP is known to be synergistic with PTFE as well as with MoDTC leading to very low friction and wear numbers. Functionalized PTFE used in the study forms a complex with ZDDP and its degradation products forming protective tribofilms on the surface. ZDDP also enhances the decomposition rate of MoDTC to form lubricious MoS₂ sheets that are responsible for low friction and wear.
2. Functionalized PTFE particles owing to their rounded and curved edges combined with their synergy with ZDDP yield much lower wear numbers and COF values; the irradiation state and the particle size along with the functionality affects the surface affinity of the PTFE particles and its tribofilm formation.
3. Under cyclic loading conditions where the sliding speed or the rpm of the opposing surfaces is fixed, higher the number of load changes leads to comparatively higher wear and abrasion of

the surface. The results obtained for tests with load steps of 7.5 minutes exhibit relatively higher amount of wear and COF as compared to the tests with load steps of 15 minutes.

4. Cyclic frequency conditions where loads are maintained constant do not show a significant change in the wear & friction data for both the Blend 1 & Blend 2 grease containing ZDDP/PTFE and a combination of ZDDP/PTFE/MoDTC under ramp-up and ramp-down conditions respectively; however for Blend 1 grease at higher frequencies, the lubricating regime slowly changes to mixed lubrication or hydrodynamic lubrication regime increasing the separation of opposing surfaces reducing the asperity interaction leading to a decrease in the wear & COF values.

5. Superior AW/EP performance of the Blend 2 grease is attributed to the synergistic interaction in between a fluoropolymer like PTFE that is functionalized with an organothiophosphate like ZDDP and synergism in between ZDDP and a organo-molybdenum compound like MoDTC. The fluoropolymer acts as a fluorinating agent thereby reducing the decomposition temperature of ZDDP as well as create additional decomposition products that form a protective tribofilm on the wear surface leading to an increase in the anti-wear as well as load bearing capabilities. The ZDDP is also responsible for enhancing the decomposition of MoDTC to form MoS₂ sheets on the wear surface that reduce friction and wear.

CHAPTER 7

CONCLUSIONS

The current study was focused on developing & testing of high performance greases with optimum AW/EP properties under spectrum loading conditions. The research emphasizes on developing new greases with higher AW/EP capabilities without MoS₂ particles. Some of the conclusions drawn are:

1. Due to the morphology of the MoS₂ particles, they behave as a pro-abrasive agent at lower loads which are not sufficient to overcome Van der Waals forces present at the S-S layer interface in the MoS₂ structure that is responsible for shearing of lamellar layers forming a tribofilm on the wear surface. It was also found out that increasing the amount of MoS₂ particles in the grease leads to an increase in wear & friction.
2. The morphology of the MoS₂ (milled & un-milled) and the PTFE particles has a significant impact on the wear and frictional performance of the formulated greases under spectrum loading conditions. Unmilled MoS₂ particles are the most abrasive as compared to the other additives as their sharp edges and corners scrape through the wear surface if the MoS₂ particles are not oriented in the direction of shearing. Milled MoS₂ particles owing to their rounded edges and blunt corners yield lower wear numbers and COF values when compared to the grease containing unmilled MoS₂ particles; on the other hand PTFE particles also have rounded and curved edges, combined with their synergy with ZDDP yield much lower wear numbers and COF values when compared to the grease containing MoS₂ particles.
3. Under cyclic loading conditions where the sliding speed or the rpm of the opposing surfaces is fixed, higher the number of load changes leads to relatively higher wear and abrasion of the surface. The results obtained for tests with load steps of 7.5 minutes in all the cases exhibit higher amount of wear and COF as compared to the tests with load steps of 15 minutes.

4. Cyclic frequency conditions where loads are maintained constant show a small variation in the wear & friction data for all the grease blends under ramp-up and ramp-down conditions respectively; the wear numbers are the highest for Blend 1 grease containing unmilled MoS₂ particles and the lowest for Blend 4 grease containing a combination of ZDDP/PTFE/MoDTC. It was also seen that for the Blend 1 & 2 grease at higher frequencies of 1800 rpm, there is a sudden drop in the torque and COF values; this is attributed to the lubricating regime slowly changing to mixed lubrication or hydrodynamic lubrication regime increasing the separation of opposing surfaces reducing the asperity interaction leading to a decrease in the wear & COF values. This trend is not seen in the Blend 3 & 4 grease containing a combination of ZDDP/PTFE and ZDDP/PTFE/MoDTC.

5. Under cyclic loading conditions for Blend 1 & 2 grease containing Unmilled and Milled MoS₂ particles, the ramp down tests exhibit relatively higher wear and COF values as compared to the ramp-up tests; a protective tribofilm is formed on the wear surface initially at lower loads in the ramp-up tests that protects the wear surface from wear and abrasion at higher load; whereas for the Blend 3 & 4 greases there is no significant variation in the wear & COF values for ramp-up & down tests.

6. Superior AW/EP performance of the Blend 3 grease is attributed to the synergistic interaction in between a fluoropolymer like PTFE that is functionalized with an organothiophosphate like ZDDP. The fluoropolymer acts as a fluorinating agent thereby reducing the decomposition temperature of ZDDP as well as create additional decomposition products that form a protective tribofilm on the wear surface leading to an increase in the anti-wear as well as load bearing capabilities. For the Blend 4 grease containing organomolybdenum compounds like MoDTC, there is a synergy in between ZDDP & MoDTC as well as ZDDP & PTFE giving superior wear and friction performance.

7. The traditional four-ball test method (ASTM D2266) is used for screening of greases wherein the test parameters are held constant and actual bearing conditions may vary significantly from

the applied parameters. The approach using spectrum loading conditions wherein the test parameters are varied might be helpful to understand the behavior of lubricants under varying conditions though it might not be necessarily representing the scenario under actual applications. The applied load dictates activation of chemistries, the entry of grease in between the interacting surfaces is controlled by the test frequencies (rpm) and the duration of the test dictates the durability of greases.

CHAPTER 8

SUGGESTED FUTURE WORK

After developing a number of greases and carrying out a variety of tests, there are a couple of suggestions that would be worth doing in the near future. One of the difficult practical aspects of the ball samples obtained from the Four-ball tests is with the mounting and using a wide range of characterization techniques to study the wear surface and to understand the tribofilm in more detail. Only elementary characterization techniques like SEM, EDS and Optical microscopy were done in the current study. It is suggested upon modifying the samples, XANES and XPS analysis could be performed in the future to understand the chemical nature of tribofilms on the surface. Another suggestion for the future work would be to test and to understand the synergism of the additive chemistries in lubricants under spectrum loading conditions in more detail. The mechanical properties of the tribofilms were not tested in the present study as these experiments are time consuming and would need a lot of sample preparation for the four-ball samples. It is suggested that Nano-indentation studies be performed.

APPENDIX A

PROTOCOL FOR GREASE PREPARATION

PROTOCOL FOR GREASE PREPARATION

Greases were prepared in batches of 200 grams each. The grease upon preparation was kept in cleaned polypropylene containers away from moisture and direct sunlight. Before testing the grease, it was stirred using a micro-spatula so as to achieve appropriate consistency and overcome the problem of oil separation. Following is the procedure that was used for developing all the four grease blends.

A kitchen aid blender was used for blending of the greases. Its electrical specifications were 120 volts, a power rating of 250 W, 60 Hz frequency and 1 gallon of blending capacity. The speed of the mixer used for blending was about 100 rpm. It had a stainless steel bowl and was cleaned with hexane before using it every time for blending. Each grease formulation was blended for about 2 hours and every 15-20 minutes the grease that was sticking to the sides of the steel bowl was scraped using a spatula and then the blending was continued again.

1. The first grease blend was prepared using techfine or unmilled MoS₂ that was available off the shelf; it was supplied by Climax Molybdenum. A total of 3 wt. % MoS₂ was used in the base grease. The average particle size of techfine grade MoS₂ was in a range of 5-20 μm according to the supplier as well as approximate measurement of the particle sizes from SEM images which had a micron marker scale on it. The mixture was blended using a kitchen aid mixer for about 2 hours. Every 15-20 min the grease that was sticking to the sides of steel bowl was scraped and collected back at the bottom of the bowl and then the mixing was continued.

2. The second grease blend was prepared using ball-milled MoS₂. The simplest way to achieve this was by using a ball-mill; techfine MoS₂ was taken and mixed with an industrial solvent like hexane in 1:1 ratio by weight. This mixture was taken in a 250 ml HDPE (High Density Poly-Ethylene) bottle. To this mixture 40 wt. % of zirconia balls of varying sizes was added. This entire mixture was then subjected to milling in a planetary ball-mill continuously for about 48 hours. Upon milling, the contents from the bottle were filtered through a steel mesh so as to separate the zirconia balls. After separation the filtrate consisting of hexane and milled MoS₂

was kept in a chemical fume hood at room temperature for about 24 hours so as to extract hexane out of it. Hexane was added as it served as a dispersant medium which made sure that particle agglomeration didn't occur post the milling process. The ball-milled MoS₂ was then added to Li-base grease and mixed using a kitchen aid blender for about 2 hours. 3 wt. % of the milled MoS₂ was taken so that a direct co-relation could be established in between the properties obtained from the Blend 1 and Blend 2 grease that contained unmilled and milled MoS₂ respectively.

3. The third grease blend was prepared using a mixture of functionalized PTFE (Poly tetrafluoroethylene) and ZDDP (Zinc dialkyl dithiophosphate). About 3 wt. % of ZDDP & 2 wt. % of PTFE was used in Lithium base grease. The PTFE & ZDDP were taken in a steel bowl and mixed using a spatula so that PTFE gets functionalized with dithiophosphate groups; grease was added to this mixture and was blend in a kitchen aid blender for about 2 hours in a similar way.

4. The fourth grease blend consisted of functionalized PTFE, ZDDP and MoDTC (Molybdenum Dithiocarbamate) in a ratio of 3:2:2 wt. %. This grease blend was tested so as to study the effect friction modifiers on the grease that contains a mixture of PTFE & ZDDP. The three additives were first taken in the steel bowl of the kitchen aid and stirred manually with a spatula so that the PTFE gets functionalized with the dithiophosphate and dithiocarbamate functional groups. The Li-base grease is then added to this mixture and stirred in the kitchen aid for 2 hours as described in the section earlier

APPENDIX B

PROTOCOL FOR RUNNING THE FOUR-BALL WEAR TESTS AND CLEANING
METHODOLOGIES

A test protocol for running the Four-ball tribometer was followed in the laboratory so as to get consistent and reproducible outcomes. The details of the protocol are as follows:

LOADING THE SAMPLE/WEAR TEST

1. E52100 Chrome-plated ½ inch diameter stainless steel balls were ordered from McMaster Carr and were cleaned thoroughly with an industrial solvent like hexane before testing it on the machine.
2. The required grease formulation that was to be tested is added to the grease-cup in the four-ball machine to fill roughly about 2/3rd the amount. Care should be taken so as to make sure that there are no air-bubbles.
3. Three of steel balls that are previously cleaned are placed in the grease-filled cup and pressed so that they are at the bottom of the cup. A Clamp ring is inserted with the inclined side downwards so that the balls are held in place.
4. If needed more grease can be added to the grease cup so that amount of grease present matches the height of the ball-holder assembly.
5. Locking nut is tightened on the assembly so that the grease and the steel balls are secure.
6. This whole assembly is placed in the specimen clamp and is placed in the Four-ball machine.
7. The ball collet that holds the top ball is hand pressed in the collet and is inserted into the drive spindle of the four-ball machine.
8. The thermocouple connections are made and the safety doors are closed.
9. The CompendX software is used to program and load the test file setup. This file contains all the necessary information for the SLIM (Serial Link Interface Module) to control the machine and carry out all the tasks. The data-file path is chosen so as to save the test data on a particular file in a particular location on the computer.
10. The load and torque zero are adjusted before the start of the test so that the output values recorded have minimal deviation from the measured values.

11. The four-ball machine is now ready to carry out tests. The start button on the CompendX screen is pressed and the test runs as programmed in the test file.

UNLOADING THE ASSEMBLY

1. After the test terminates, the safety door is opened and the thermocouple plugs are disconnected.
2. The whole four-ball assembly is removed before proceeding and inserted on the bench top clamps; the three stationary balls are retrieved for wear analysis.
3. The ball from the collet is removed and by inserting the long rod into the top of the shaft (above the clutch); if the shaft rotates while unscrewing, the shaft is held using a spanner and turned. The long rod is removed from the top after removing the ball collet.
4. A steel punch (provided by Phoenix Tribology) is inserted into the hole provided on the rear of the collet. The ball pops out and is stored.
5. All the balls are cleaned and hexane and stored in petri dishes for further analysis.

FINAL CLEANING

The grease is cleaned from the machine using hexane. For running consecutive tests, it should be ensured that the whole machine assembly cools down to room temperature. A chemical hood can be used if there is a presence of objectionable odor emitted from the lubricants after the test. A mounting assembly that was made in-house was used to mount the balls and image them under optical microscopy as well as SEM. The values are noted down and presented in the study. Appendix B content goes on this page.

REFERENCES

- [1] ASTM. Standard test method for wear preventative characteristics of lubricating grease (four-ball method) (ASTM D 2266). In: Anonymous ASTM D2266 Standards, Philadelphia, PA: ASTM; 1996.
- [2] Suresh A, Mourhatch R, Aswath P. Effect of Test Parameters on the Four Ball Wear and Weld Performance of Greases with MoS₂ and without MoS₂ as EP Additive. NLGI Spokesman (National Lubricating Grease Institute) 2009;73(1):24-35.
- [3] History of Tribology (<http://www.centrollubrication.com/en/history-of-tribology>). Electronic;2012.
- [4] Rudnick LR. Synthetics, mineral oils, and bio-based lubricants: chemistry and technology. : CRC, 2005.
- [5] Great Britain. Dept. of Education. Lubrication (tribology), education and research: a report on the present position and industry's needs. : HM Stationery Off., 1966.
- [6] Dašić P, Franek F, Assenova E, Radovanovic M. International standardization and organizations in the field of tribology. Ind Lubr Tribol 2003;55:287-91.
- [7] Czichos H. Tribology: a systems approach to the science and technology of friction, lubrication, and wear. : Elsevier Science & Technology, 1978.
- [8] Guichelaar P, Herguth WR, Bruce RW, Douglas G. Basics of Friction (<http://www.stle.org/resources/lubelearn/friction/default.aspx>). Electronic;2012.
- [9] Bhushan B. Modern Tribology Handbook, Two Volume Set. : CRC, 2000.
- [10] Introduction to Engineering and Statics (<http://www.engin.brown.edu/courses/en3/Notes/Statics/friction/friction.htm>). Brown University, Division of Engineering;2012.

- [11] Singer IL, Pollock H. Fundamentals of friction: macroscopic and microscopic processes. : Springer, 1992.
- [12] Ludema KC. Friction, wear, lubrication: a textbook in tribology. : CRC, 1996.
- [13] Spurr R, Newcomb T. The Adhesion Theory of Friction. Proceedings of the Physical Society. Section B 2002;70:98.
- [14] Bowden F, Thomas P. The surface temperature of sliding solids. Proceedings of the Royal Society of London. Series A. Mathematical and Physical Sciences 1954;223:29-40.
- [15] STLE- Basics of Wear (<http://www.stle.org/resources/lubelearn/wear/default.aspx>). Electronic;2012.
- [16] England G. Wear Resistance (<http://www.gordonengland.co.uk/wear.htm>). Electronic;2012.
- [17] Bhushan B. Modern Tribology Handbook, Volume 2. 2000;2:1760.
- [18] Hokkirigawa K. Introduction to wear. Toraibarojisuto/Journal of Japanese Society of Tribologists 2001;46:271.
- [19] Hamrock BJ, Schmid SR, Jacobson BO. Fundamentals of fluid film lubrication. : CRC, 2004.
- [20] Dowson D, Higginson GR. Elastohydrodynamic Lubrication. London, UK: Pergamon Press, 1966.
- [21] Archard JF, Cowking EW. Elastohydrodynamic lubrication at point contacts. Proc Inst Mech Eng 1965-1966;180:47-56.
- [22] Kopeliovich D. Lubrication Regimes (http://www.substech.com/dokuwiki/doku.php?id=lubrication_regimes). Electronic 2012;2012.
- [23] Woydt M, Wäsche R. The history of the Stribeck curve and ball bearing steels: The role of Adolf Martens. Wear 2010;268:1542-6.
- [24] Anderson W, Wedeven L, Herguth WR, Bruce RW, Douglas G,. STLE-Basics of Lubrication (<http://www.stle.org/resources/lubelearn/lubrication/default.aspx>). Electronic 2012;2012.
- [25] Grease - The world's first lubricant. NLGI Spokesman 1995;59 (5):1-8.

- [26] Rudnick LR. Lubricant additives: chemistry and applications. : CRC, 2009.
- [27] NLGI S. Lubricating grease guide, Kansas city. 1996;4.
- [28] Todd PR. The 2000 grease production survey report: What does it mean? NLGI spokesman 2002;65:21-31.
- [29] Stachowiak G, Batchelor AW. Engineering Tribology. BUTTERWORTH HEINEMANN: Elsevier, 2005.
- [30] Cann P. Grease degradation in a bearing simulation device. Tribol Int 2006;39:1698-706.
- [31] Lugt PM. A review on grease lubrication in rolling bearings. Tribol Trans 2009;52:470-80.
- [32] Vergne P, Blettner G. Lubricating greases, correlation between composition and rheology. 1998:1-12.
- [33] Klamann D, Rost R, Esso A. Lubricants and related products: synthesis, properties, applications, international standards. : Verlag chemie, 1984.
- [34] Cann P. Thin-film grease lubrication. Proc Inst Mech Eng Part J 1999;213:405-16.
- [35] Godfrey D. Friction of greases and grease components during boundary lubrication. ASLE TRANSACTIONS 1964;7:24-31.
- [36] Williamson B, Kendall D, Cann P. The influence of grease composition on film thickness in EHD contacts. NLGI spokesman 1993;57:13-8.
- [37] Hurley S, Cann P. IR spectroscopic analysis of grease lubricant films in rolling contacts. Tribology Series 1999;36:589-600.
- [38] Kaneta M, Ogata T, Takubo Y, Naka M. Effects of a thickener structure on grease elastohydrodynamic lubrication films. Proc Inst Mech Eng Part J 2000;214:327-36.
- [39] Wills JG. Lubrication fundamentals. 1990.
- [40] NLGI LGG. National Lubricating Grease Institute. Kansas City, MO 1994.
- [41] ASTM International. ASTM D1403-10, Standard Test Method for Cone Penetration of Lubricating Grease Using One-Quarter and One-Half Scale Cone Equipment. In: Anonymous ASTM D1403-10, Standard Test Method for Cone Penetration of Lubricating Grease Using

One-Quarter and One-Half Scale Cone Equipment, West Conshohocken, PA: Book of ASTM standards; 2003.

[42] ASTM International. ASTM D2265-06, Standard Test Method for Dropping Point of Lubricating Grease Over Wide Temperature Range. In: Anonymous ASTM D2265-06, Standard Test Method for Dropping Point of Lubricating Grease Over Wide Temperature Range, West Conshohocken, PA: Book of ASTM standards; 2003.

[43] Polishuk A. Properties and performance characteristics of some modern lubricating greases. 1976.

[44] Boner CJ. Manufacture and application of lubricating greases. Manufacture and Application of Lubricating Greases 1954.

[45] Hotten B. Advances in Petroleum Chemistry and Refining.

[46] Wilson J. Three-dimensional structure of grease thickener particles. NLGI Spokesman (National Lubricating Grease Institute) 1964;3:372-9.

[47] Czarny R. Effects of changes in grease structure on sliding friction. Ind Lubr Tribol 1995;47:3-7.

[48] Lubrizol Corp. Ready Reference for Grease. In: Anonymous Ready Reference for Grease, Wickliffe, OH: Lubrizol; October 1999.

[49] The Exxon Corporation. In: Anonymous Encyclopedia for the user of Petroleum Products: Lubertext; 1993, p. 10.

[50] Ogawa T. NLGI Conference Proceedings. October 1997:21-9.

[51] Tocci L. Transparent Grease Bears a Heavy Load. 1997.

[52] Killeffer DH, Linz A, Pauling L. Molybdenum compounds: their chemistry and technology. : Interscience Publishers, 1952.

[53] Koehler W. KOEHLER 1955.

[54] Bell M, Findlay J. Molybdenite as a new lubricant. Phys.Rev 1941;59:922.

- [55] Dickinson RG, Pauling L. The crystal structure of molybdenite. J Am Chem Soc 1923;45:1466-71.
- [56] Holinski R, Gänsheimer J. A study of the lubricating mechanism of molybdenum disulfide. Wear 1972;19:329-42.
- [57] Pauling L. The nature of the chemical bond and the structure of molecules and crystals: an introduction to modern structural chemistry. : Cornell University Press, 1960.
- [58] Winer WO. Molybdenum disulfide as a lubricant: a review of the fundamental knowledge. Wear 1967;10:422-52.
- [59] Bryant P, Gutshall P, Taylor L. A study of mechanisms of graphite friction and wear. Wear 1964;7:118-26.
- [60] Deacon R, Goodman J. Lubrication by lamellar solids. Proceedings of the Royal Society of London. Series A, Mathematical and Physical Sciences 1958:464-82.
- [61] Machinery Lubrication - Solid Film Lubricants (<http://www.machinerylubrication.com/Read/861/solid-film-lubricants>). Electronic;2012.
- [62] Finch G. The sliding surface. Proceedings of the Physical Society. Section B 2002;63:465.
- [63] Feng IM. Lubricating Properties of Molybdenum Disulfide. Lubrication Engineering 1952;8:285-8.
- [64] Savage RH. Graphite lubrication. J Appl Phys 1948;19:1-10.
- [65] Braithwaite ER. Lubrication and lubricants. : Elsevier, 1967.
- [66] Barry H, Binkelman J. Evaluation of Molybdenum Disulfide in Lubricating Greases. 7 P. CLIMAX MOLYBDENUM CO., 1270 AVENUE OF THE AMERICAS, NEW YORK, N.Y. 10020 1966.
- [67] Peterson MB. Friction and wear investigation of molybdenum disulfide I: effect of moisture. 1953.
- [68] Midgley J. The frictional properties of molybdenum disulphide. J. Inst. Petrol 1956;42:316-9.
- [69] Boyd J, Robertson B. The friction properties of various lubricants at high pressure. , 1945.

- [70] Johnson RL, Godfrey D, Bisson EE. Friction of solid films on steel at high sliding velocities. : National Advisory Committee for Aeronautics, 1948.
- [71] Devine M, Lamson E, Stallings L. Molybdenum Disulfide Diester Lubricating Greases. J.Nat.Lubricating Grease Inst., Preprint 1964.
- [72] Vineall G, Taylor A. Oxide formation from molybdenum disulphide. Ind Lubr Tribol 1961;13:21-4.
- [73] Freeport-McMoran Company. Climax Molybdenum Particle Size (http://www.climaxmolybdenum.com/TechLib/ParticleBulletinMoSulfide_1107.pdf). Electronic;2012.
- [74] Suresh A. Synergistic and antagonistic effect of sulfur-based additives on the performance of greases with ZDDP and PTFE. ProQuest Dissertations and Theses 2009.
- [75] Mourhatch R, Aswath PB. Tribological behavior and nature of tribofilms generated from fluorinated ZDDP in comparison to ZDDP under extreme pressure conditions---Part 1: Structure and chemistry of tribofilms. Tribol Int 2011;44:187-200.
- [76] Chevron Corporation. Products Catalogue (<http://www.lubritecinc.com/PDF/2008synadditivescolor.pdf>). Electronic;2012.
- [77] DuPont Corporation. Product technical information (http://www2.dupont.com/Teflon_Industrial/en_US/assets/downloads/h58358.pdf). Electronic;2012.
- [78] Freuler HC. Modified lubricating oil 1944.
- [79] Paddy JL, Lee NC, Waters J, Trott DN. Zinc dialkyl Dithiophosphate oxidation by cumene hydroperoxide: kinetic studies by Raman and phosphorus -31 NMR spectroscopy. Trib Trans 1990;33:15-20.
- [80] Parekh K, Chen X, Aswath PB. Synthesis of Fluorinated ZDDP Compounds. Tribol Lett 2009;34:141-53.

- [81] Bovington CH, Dacre B. The Adsorption and Reaction of Decomposition Products of Zinc Di-Isopropylidithiophosphate on Steel. ASLE Transactions 1984;27:252-8.
- [82] Kim B, Mourhatch R, Aswath PB. Properties of tribofilms formed with ashless dithiophosphate and zinc dialkyl dithiophosphate under extreme pressure conditions. Wear 2010;268:579-91.
- [83] Bell J, Delargy K. The composition and structure of model zinc dialkyldithiophosphate anti-wear films. Proceedings of Eurotrib 1993;93:328-33.
- [84] Willermet PA, Carter RO,III, Boulos EN. Lubricant-derived tribochemical films-An infra-red spectroscopic study. Tribology Int 1992;25:371,371-380.
- [85] Tripaldi G, Vettor A. Friction behavior of ZDDP films in the mixed, boundary/EHD regime. 1996.
- [86] Yamaguchi E, Onopchenko A, Francisco M, Chan C. The relative oxidation inhibition performance of some neutral and basic zinc dithiophosphate salts. Tribol Trans 1999;42:895-901.
- [87] Naitoh Y, Akiyama K. Engine oil composition 2000.
- [88] Zeus Industrial Products Inc. Chemical resistance of Fluoropolymers (<http://www.coleparmer.com/TechLibraryArticle/827>). Electronic;2012.
- [89] DuPont Corporation. Fluoro-additives Brouchere. 2005.
- [90] Bowden FP, Tabor D. The friction and lubrication of solids. Clarendon Press, 1986, 1986:374.
- [91] Allen C, Drauglis E. Boundary layer lubrication: monolayer or multilayer. Wear 1969;14:363-84.
- [92] Isoyama H, Sakurai T. The lubricating mechanism of di-< i> u</i>-thio-dithio-bis (diethyldithiocarbamate) dimolybdenum during extreme pressure lubrication. Tribology 1974;7:151-60.

- [93] Braithwaite ER, Greene AB. A critical analysis of the performance of molybdenum compounds in motor vehicles. *Wear* 1978;46:405-32.
- [94] Mitchell PCH. Oil-soluble Mo-S compounds as lubricant additives. *Wear* 1984;100:281-300.
- [95] Misra AK, Mehrotra AK, Srivastava RD. Antiwear characteristics of additives: Synergistic and adverse effects. *Wear* 1975;31:345-57.
- [96] Tung CY, Hsieh S, Huang G, Kuo L. Determination of friction-reducing and antiwear characteristics of lubricating engine oils compounded with friction modifiers. *Lubr.Eng.* 1988;44:856-65.
- [97] Unnikrishnan R, Jain MC, Harinarayan AK, Mehta AK. Additive-additive interaction: An XPS study of the effect of ZDDP on the AW/EP characteristic of molybdenum based additives. *Wear* 2002;252:240-9.
- [98] Asthana P. *Micro-and nano-scale experimental approach to surface engineer metals* 2006.
- [99] Baldwin BA. Relative antiwear efficiency of boron and sulfur surface species. *Wear* 1977;45:345-53.
- [100] McFadden C, Soto C, Spencer ND. Adsorption and surface chemistry in tribology. *Tribol Int* 1997;30:881-8.
- [101] Biswas S. Some mechanisms of tribofilm formation in metal/metal and ceramic/metal sliding interactions. *Wear* 2000;245:178-89.
- [102] Heinicke G, Hennig HP, Thiessen PA. *Tribochemistry*. : Hanser, 1984.
- [103] Komvopoulos K, Pernama SA, Ma J, Yamaguchi ES, Ryason PR. Synergistic effects of boron-, sulfur-, and phosphorus-containing lubricants in boundary lubrication of steel surfaces. *Tribol Trans* 2005;48:218-29.
- [104] Eglin M, Rossi A, Spencer ND. X-ray photoelectron spectroscopy analysis of tribostressed samples in the presence of ZnDTP: a combinatorial approach. *Tribology Letters* 2003;15:199-209.

- [105] Graham J, McCague C, Norton P. Topography and nanomechanical properties of tribochemical films derived from zinc dialkyl and diaryl dithiophosphates. Tribology letters 1999;6:149-57.
- [106] Komvopoulos K, Pennecot G, Yamaguchi ES, Yeh S. Antiwear Properties of Blends Containing Mixtures of Zinc Dialkyl Dithiophosphate and Different Detergents. Tribol Trans 2008;52:73-85.
- [107] Gellman AJ, Spencer ND. Surface chemistry in tribology. Proc Inst Mech Eng Part J 2002;216:443-61.
- [108] Myshkin NK. Friction transfer film formation in boundary lubrication. Wear 2000;245:116-24.
- [109] Pearson R. Hard and Soft Acids and Bases, Dowden Hutchinson and Ross, Strousburg, PA, 1973;; RG Pearson. J Org Chem 1989;54:1423.
- [110] Lüth H. Surfaces and interfaces of solids. : Springer, 1993.
- [111] Pitchumani P, Aswath P, Bagi S, Sharma V, Chen X. Wear and Tribofilm Formation with Zinc-Free Antiwear Additives. Fundamentals II May 2012;67th Annual STLE Meeting, St Louis, MO:28.
- [112] Chevron Corporation. Texaco Marfak mp2 grease (http://www.rolandjrobertdistributor.com/files/Markfak_mp2.pdf). Electronic April 2002;2012.
- [113] Kitchen Aid Classic Series- K45SSWH (<http://www.kitchenaid.com/flash.cmd?/#/product/K45SSWH>). Electronic 2012;2012.
- [114] Ball milling machines (http://www.lagunaclay.com/catalog/pdf/lcc_equip2.pdf). Electronic;2012.
- [115] Mistry A, Bradbury R. Investigation into the effect of molybdenum disulphide and graphite on the load carrying capacity of a grease. NLGI Spokesman 2002;66:25-9.
- [116] RT Vanderbilt Company Inc. MSDS-Molyvan A (<http://www.rtvanderbilt.com/documents/MSDS/US/29007.pdf>). Electronic;2012:1-7.

- [117] Four Ball sketch (
http://tribolab.mas.bg.ac.rs/english/images/equipment/four%20ball_sketch.jpg).
Electronic;2012.
- [118] Khedkar J, Negulescu I, Meletis EI. Sliding wear behavior of PTFE composites. *Wear* 2002;252:361-9.
- [119] Hao X, Zhang J, Guo Y, Zhang H. Studies on porous and morphological Structures of expanded PTFE Membrane through biaxial stretching technique. *International Nonwovens Journal* 2005;14:31-8.
- [120] ASTM International. ASTM D 2596-97, Standard test method for measurement of extreme-pressure properties of lubricating grease (four-ball method), *Annual Book of ASTM Standards*, Philadelphia, PA. 2003;5.01.
- [121] Risdon TJ. Evaluation of MoS₂ in Newer Grease Thickener Systems. *NLGI Spokesman* 1986;50:211-4.
- [122] Tamashuasky A. The effect of Graphite type, purity and concentration on the Performance of a Clay Filled Polyalpha Olefin Grease Based on four ball wear (ASTM 2266) with coefficient of friction and load wear index (ASTM D2596). *NLGI Spokesman* 2002;65 (12):10-25.
- [123] Ballester E, Sui M, Fillion C. Effect of PTFE particle size on wear and coefficient of friction. *NLGI Spokesman* 2001;65:22-7.
- [124] Sivik MR, Zeitz JB, Bayus D. Interactions of a zinc dithiophosphate with lithium 12-hydroxystearate grease. *NLGI spokesman* 2002;66:20-4.
- [125] Gansheimer J, Holinski R. MOLYBDENUM DISULFIDE IN OILS AND GREASES UNDER BOUNDARY CONDITIONS. 1973;95 Ser F:242-8.
- [126] ASTM International. ASTM D5183-05 (2011) Standard Test Method For Determination of Coefficient of Friction of Lubricants Using the Four-Ball Wear Test Machine. DOI: 10.1520/D5183-05R11. In: Anonymous Book of ASTM standards, West Conshohocken, PA: ASTM; 2003.

- [127] Aswath PB, Patel K, Munot S, Elsenbaumer RL. Development of a High Performance Low Molybdenum Disulfide Grease. NLGI Spokesman (National Lubricating Grease Institute) 2007;70(11):24-32.
- [128] Lansdown A. Molybdenum disulphide lubrication. : Elsevier Science Limited, 1999.
- [129] Fusaro RL. Effect of Substrate Surface Finish on the Lubrication and Failure Mechanisms of Molybdenum Disulfide Films. ASLE transactions 1982;25:141-56.
- [130] Gao C, Bredell L, Kuhlmann-Wilsdorf D, Makel DD. Micromechanics of MoS₂ lubrication. Wear 1993;162–164, Part A:480-91.
- [131] Erdemir A. Review of engineered tribological interfaces for improved boundary lubrication. Tribol Int 2005;38:249-56.
- [132] Komvopoulos K, Saka N, Suh N. The mechanism of friction in boundary lubrication. ASME, Transactions, Journal of Tribology 1985;107:452-62.
- [133] Persson B. Theory of friction and boundary lubrication. Physical Review B 1993;48:18140.
- [134] Mas R, Magnin A. Rheology of colloidal suspensions-case of lubricating greases. J Rheol 1994;38:889-908.
- [135] Hussey G. Alteration of grease characteristics with new generation polymers. NLGI spokesman 1987;51:175-81.
- [136] Rizvi SQA. A comprehensive review of lubricant chemistry, technology, selection, and design. : ASTM International, 2009.
- [137] Antony JP, Mittal BD, Naithani KP, Misra AK, Bhatnagar AK. Antiwear/extreme pressure performance of graphite and molybdenum disulphide combinations in lubricating greases. Wear 1994;174:33-7.
- [138] Srivastava R, Mehrotra A, Sinha B, Agnihotri R. Graphite and Molybdenum Disulphide Lubricants Performance in Relation to Base Fluids. :6.2,6.1.
- [139] Bartz W. Solid lubricant additives—effect of concentration and other additives on anti-wear performance. Wear 1971;17:421-32.

- [140] Bartz W, Holinski R, Xu J. Wear life and frictional behavior of bonded solid lubricants. Lubrication engineering 1986;42:762-9.
- [141] Fischer FG, Corn AD, Huber RG. Graphite and Molybdenum disulfide synergism. NLGI Spokesman 1982;XLVI, 6:190.
- [142] Nehme G, Mourhatch R, Aswath PB. Effect of contact load and lubricant volume on the properties of tribofilms formed under boundary lubrication in a fully formulated oil under extreme load conditions. Wear 2010;268 (9-10):1-1147.
- [143] Spikes HA. The history and mechanisms of ZDDP. Trib Lett 2004;17:469-489.
- [144] Nicholls MA, Do T, Norton PR, Kasrai M, Bancroft GM. Review of the lubrication of metallic surfaces by zinc dialkyl-dithiophosphates. Tribol Int 2005;38:15-39.
- [145] Rokosz MJ, Chen AE, Lowe-Ma CK, Kucherov AV, Benson D, Paputa Peck MC et al. Characterization of phosphorus-poisoned automotive exhaust catalysts. Appl Catal B Environ 2001;33:205,205-215.
- [146] Stolarski T. Remarks on the wear of a journal bearing lubricated by a grease containing a powdered PTFE additive. Tribol Int 1976;9:161-3.
- [147] Stolarski T, Olszewski O. EXPERIMENTAL STUDY OF THE FRICTIONAL MECHANISM IN A JOURNAL BEARING LUBRICATED WITH GREASE CONTAINING POWDERED PTFE. Wear 1976;39:377.
- [148] Akdogan G, Stolarski TA, Tobe S. Wear of metal/PTFE coatings in rolling line contact. J Mater Sci 2002;37:5013-9.
- [149] Aswath PB, Patel K, Mourhatch R, Shaub H, Elsenbaumer RL, Owen DP. High performance lubricants and lubricant additives for crankcase oils, greases, gear oils and transmission oils. 2011;11/870,993:1-32.
- [150] Parekh K, Aswath PB, Shaub H, Elsenbaumer RL. Low-Phosphorous Lubricant Additive. 2006;11/182,023.

- [151] Cann P, Spikes HA, Cameron A. THICK FILM FORMATION BY ZINC DIALKYLDITHIOPHOSPHATES. ASLE transactions 1983;26:48-52.
- [152] Somayaji A, Mourhatch R, Aswath PB. Nanoscale Properties of Tribofilms from ZDDP and Fluorinated ZDDP in the Presence and Absence of Antioxidants. Journal of Nanoscience and Nanotechnology 2007;7:4378-4390.
- [153] Mourhatch R, Parekh K, Aswath PB. A multi technique study of the tribological behavior and the tribofilms generated from fluorinated thiophosphate compounds in comparison to normal ZDDP. Proceedings of STLE/ASME International Joint Tribology Conference;2006:IJTC2006-12137.
- [154] Aswath PB, Shaub H, Mourhatch R, Patel K, Owen DP, Eisenbaumer RL. High Performance Lubricant Additives. High performance lubricants and lubricant additives for crankcase oils, greases, gear oils and transmission oils 2010;US 7754662 B2:1-32.
- [155] Shaub H, Aswath PB, Huq MZ. Engine Oil Additive. Engine oil additive 2006;US 7074745 B2:1-8.
- [156] Kim BH, Jiang J, Aswath PB. Mechanism of Wear at Extreme Loads and Boundary Conditions with Ashless Anti-wear Additives: Analysis of Wear Surfaces and Wear Debris. Wear 2011;270(3-4):181-94.
- [157] Nehme GN. The Effect of $\text{FeF}_3/\text{TiF}_3$ catalysts on the thermal and tribological performance of plain oil ZDDP under extreme pressure loading. Wear 2011;278-279:9-17.
- [158] Hague T, Morina A, Neville A, Kapadia R, Arrowsmith S. Study of the ZDDP antiwear tribofilm formed on the DLC coating using AFM and XPS techniques. Journal of ASTM International 2007;4.
- [159] Somayaji A, Aswath PB. Role of Antioxidants on Oxidation Stability of Oils with ZDDP and F-ZDDP and Chemical Structure of Tribofilms with XANES. Trib Trans 2009;52:511-25.
- [160] de Barros'Bouchet MI, Martin JM, Le-Mogne T, Vacher B. Boundary lubrication mechanisms of carbon coatings by MoDTC and ZDDP additives. Tribol Int 2005;38:257-64.

- [161] De Barros Bouchet, Maria Isabel, Le Mogne T, Martin JM, Vacher B. Lubrication of carbon coatings with MoS₂ single sheet formed by MoDTC and ZDDP lubricants. *Lubr Sci* 2006;18:141-9.
- [162] Morina A, Neville A. Understanding the composition and low friction tribofilm formation/removal in boundary lubrication. *Tribol Int* 2007;40:1696-704.
- [163] Grossiord C, Varlot K, Martin J-, Le Mogne T, Esnouf C, Inoue K. MoS₂ single sheet lubrication by molybdenum dithiocarbamate. *Tribol Int* 1998;31:737-43.
- [164] Muraki M, Yanagi Y, Sakaguchi K. Synergistic effect on frictional characteristics under rolling-sliding conditions due to a combination of molybdenum dialkyldithiocarbamate and zinc dialkyldithiophosphate. *Tribol Int* 1997;30:69-75.
- [165] Muraki M, Yanagi Y, Sakaguchi K. Frictional Properties of Organo Molybdenum Compounds in the Presence of ZnDTPs under Rolling-Sliding Conditions (Part 1): Effect of Surface Hardness of Roller. *Japanese Journal of Tribology* 1995;40:41-52.
- [166] Kubo K, Hamada Y, Moriki K, Kibukawa M. Friction Behavior of Lubricants Containing Organo-Molybdenum Compound. II. *Toraibojisto(J.Jpn.Soc.Tribol.)* 1989;34:185-92.
- [167] Kubo K, Moriki Y, Kibukawa M. Friction behaviour of lubricants containing organo-molybdenum compounds. Part 1. Application to sulphur-phosphorus type gear lubricants. *J.JSLE* 1988;33:309.
- [168] Matsumoto K, Rossi A, Spencer N. XPS Study of Tribo-Films Formed by Phosphorus-Containing Lubricant Additives. 2000;2:1287-92.
- [169] Wagner C, Muilenberg G. *Handbook of X-ray photoelectron spectroscopy*. : Perkin-Elmer, 1979.

BIOGRAPHICAL INFORMATION

Sujay Bagi was born and raised in southern India and did his schooling in the state of Karnataka. He did his bachelors in Mechanical Engineering from BMS College of Engineering located in Bangalore, India. His final year design project was on production and properties evaluation of metal matrix composites (MMC's) used in automotive and aerospace applications. After graduation he worked for John Deere Technology Center as a Design and Analysis Engineer working on several projects related to tractors, sprayers and other heavy engineering vehicles. Having a keen interest in materials science, he decided to pursue his master's degree and secured an admission from the Materials Science & Engineering department at University of Texas at Arlington. He was appointed as a grad research assistant in the department and worked in the Tribology, Lubrication and Coatings (TLCL) laboratory under the guidance of Dr. Pranesh Aswath. He worked on several projects related to Tribological testing, lubricant formulation, materials characterization, surface analysis and metallography & failure analysis. He considers himself extremely fortunate to have worked under the guidance of Dr. Aswath. In the summer of 2012, he worked as an intern in the Polymer Solutions R&D division at Albemarle Corporation located in Baton Rouge, LA. He worked on projects aimed at understanding the lubricant degradation problems arising in gas turbines and studying the synergistic and antagonistic mechanisms of different categories of anti-oxidants used in turbines.