

PERFORMANCE ENHANCEMENT OF RASPBERRY PI SERVER FOR THE
APPLICATION OF OIL IMMERSION COOLING

by

DHAVAL HITENDRA THAKKAR

Presented to the Faculty of the Graduate School of
The University of Texas at Arlington in Partial Fulfillment
of the Requirements for the Degree of

MASTER OF SCIENCE IN MECHANICAL ENGINEERING

THE UNIVERSITY OF TEXAS AT ARLINGTON

MAY 2016

Copyright © by DHAVAL HITENDRA THAKKAR 2016

All Rights Reserved



Acknowledgements

I would like to thank Dr. DEREJE AGONAFER for giving an opportunity to work on this project and support me on all aspects. I would like to thank NSF I/UCRC for introducing this project. I would like to thank Dr. VEERENDRA MULAY from FACEBOOK for his constant support and motivation to work on this. I would like to thank Mr. JIMIL M. SHAH for being patient with us and supporting us. I would like to thank Dr. ABDOLHOSSEIN HAJI-SHEIKH and Dr. Miguel Amaya for taking time out of his busy schedule to attend my thesis dissertation. I would like to specially thank Mrs. SALLY and Mrs. DEBI for their expert advice and encouragement. I would like to finally thank my parents Mr. HITENDRA and Mrs. ARTI for standing by my side and for believing in me in every aspect.

MAY 1, 2016

Abstract

PERFORMANCE ENHANCEMENT OF RASPBERRY PI SERVER FOR THE
APPLICATION OF OIL IMMERSION COOLING

Dhaval Hitendra Thakkar, MS

The University of Texas at Arlington, 2015

Supervising Professor: Dereje Agonafer

The power consumed by Central Processing Unit (CPU) generates the heat which is undesirable and which is further responsible for the damage of Information Technology equipment. Oil Immersion cooling is one of the emerging technology which deals with the high server densities by submersing the servers in mineral oil. The study addresses the CFD analysis of Raspberry Pi computer servers with different cooling techniques and different modes of operating conditions. The thesis gives the explanation on the difference between air cooling and oil cooling with and without use of heat sinks. The study also shows the parametric analysis of heat sink for the particular case of oil immersion cooling of Raspberry Pi computers. Considering the worst case scenario, the results give an idea about the optimized performance of Raspberry Pi Server for the application of Oil Immersion Cooling. By efficient cooling techniques Raspberry pi can be used from personal computing to high end power requirements.

Table of Contents

Acknowledgements	iii
Abstract	iv
List of Illustrations	vii
Chapter 1 Overview, aim and objective	8
1.1 Overview.	8
1.2 Aim and objective.....	10
Chapter 2 Literature review.....	11
2.1 Introduction	11
2.2 Components.....	11
2.3 Heat Transfer overview.....	12
Chapter 3 CAD Modeling	13
3.1 Introduction	13
3.2 Component size	13
3.3 Air cooling	14
3.4 Analysis of Raspberry Pi in Air without heat sink.....	15
3.5 Heat Sink.....	16
3.6 Thermal image of Raspberry Pi with Heat sink.....	17
Chapter 4 Oil immersion cooling	18
4.1 Introduction	18
4.2 Properties of mineral oil compared to air	18
4.3 Mineral oil Parameters	19
4.4 Analysis of Raspberry Pi in Oil without heat sink.....	19
4.5 Thermal image of Raspberry Pi in mineral oil with Heat sink.....	20
4.6 CPU base temperature vs Power	20

Chapter 5 Immersion cooling v/s air cooling	22
5.1 Introduction	22
5.2 Air cooling v/s oil flow.....	22
5.3 Advantages notwithstanding effectiveness of immersion cooling.....	23
5.4 Immersion cooling using less energy and infrastructure	24
5.4.1 Frame work	24
5.4.2 Fan power.....	25
5.5 Immerging technology.....	25
5.6 Air cooling still popular, but has flaws	26
5.7 Liquid cooling vs air cooling	27
Chapter 6 Initial trail and proposed methodology	26
6.1 Introduction	29
6.2 Initial trail	29
6.3 Results/outcomes.....	31
6.4 Raspberri Pi immersion in oil	32
6.5 Water cooling of Raspberri Pi server	33
6.6 Experimental result	34
6.7 Experimental outcome graph.....	35
6.8 Comparison of experimental and CFD work.....	36
Chapter 7 Future study	37
References.....	38
Biographical information.....	43

List of Illustrations

Figure 1.1.1 An ideal Raspberry Pi server.....	8
Figure 1.1.2 Raspberry Pi used in drones.	9
Figure 1.1.3 Raspberry Pi used in gadgets.....	9
Figure 2.2 Components of Raspberry Pi server	12
Figure 3.1 Raspberry Pi Cad model.....	13
Figure 3.3 Air-velocity parametric study.....	15
Figure 3.4 Thermal image of Raspberry Pi server in air without heat sink.	15
Figure 3.5 Heat sink.....	16
Figure 3.6 Thermal image of Raspberry Pi server in air with heat sink.....	17
Figure 4.2 Mineral oil and air comparison.....	18
Figure 4.4 Thermal image of Raspberry Pi in Mineral oil without heat sink	19
Figure 4.5 of Raspberry Pi in mineral oil with Heat sink	20
Figure 4.6 CPU base temperature(°C) vs POWER	21
Figure 6.2 Air cooling of Raspberry Pi	27
Figure 6.3 Thermal Image of Raspberry Pi Model B	28
Figure 6.4 Raspberry Pi immersed in Opticool Fluid and powered up for temperature measurements.....	29
Figure 6.5 Cooling system for IBM power series server	30
Figure 6.6 Output data from experiment	31
Figure 6.7 CPU temperatures with Overclocking.....	32
Figure 6.8 Comparison of CFD results vs experimental results	33

Chapter 1

Overview, aim and objective

1.1 Overview

Modern day CPU generates a great amount of heat to meet the higher power output, which leads to adding of undesirable excess heat within the system. As for the most of the data processing takes place in this part of the system, the central processing units are often placed at risk of malfunction or may be a permanent damage. To regulate the temperature within the system, this excessive heat must be overcome. Also according to the Moore's law, numbers of transistors placed on the IC board will double every two years. This calls for the need of an effective cooling technology unlike the conventional air cooling.

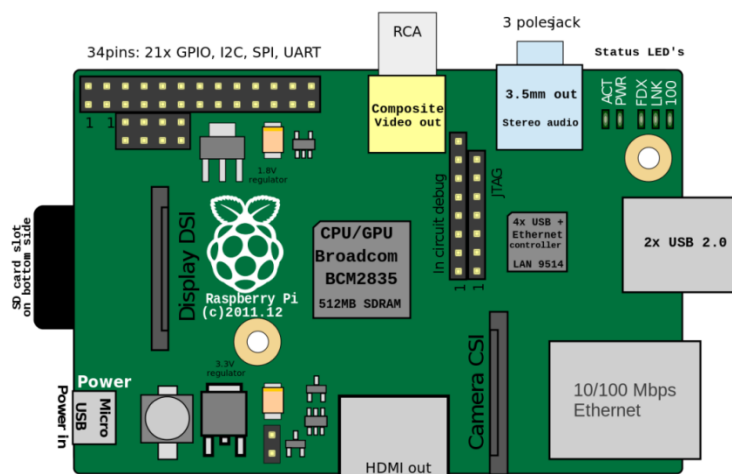

Figure 1.1.1 An ideal Raspberry Pi server

Due to the overclocking capability and its compressed size, Raspberry Pi server is considered to be the ideal device for this experiment. Figure 1.1 shows the Raspberry Pi server B model which is widely used Raspberry Pi server. As smaller size components are leading to the higher computing output, this Raspberry Pi server is the representative

of such powerful computing. There have been several advantages of this Raspberry Pi server such as Automation, media streaming, and other Robotic applications.



Fig 1.1.2 Raspberry Pi used in drones

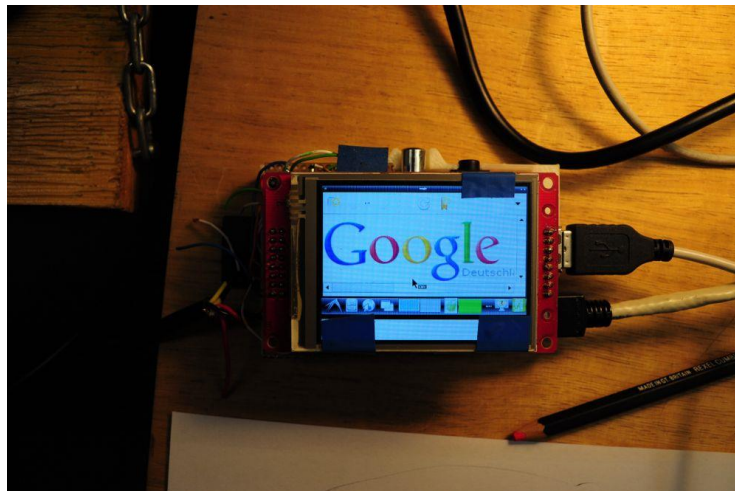

Figure 1.1.3 Raspberry Pi used in gadgets

Just like other devices, Raspberry Pi also tends to overheat when it is subjected to overclocking speeds or when the device is subjected to unusual high voltages.

In this work, the fundamental model is the submerged in equipment, where it is loaded with mineral oil. The point and goals of the study in this thesis are displayed in the following area. The outline of the proposition is described in this part.

1.2 Aim and objective

This thesis aims at increasing the performance of Raspberry Pi server with the help of oil immersion cooling. The objective of this work is stated below.

1. To focus on the understanding of the impact of mineral oil immersion on the reliability and operability of Raspberry Pi server and its component.
2. To find an approach that is through material testing and analysis.
3. To focus on the differences in the heat capacitance of mineral oil and air.
4. To hypothesize the outcomes when the equipment is made to undergo various numbers of cycles.
5. To focus on the developing a correct methodology for oil immersion and scrutinize and plan for the procedure of the experiment.
6. To validate the results of experimental comparative study of air cooling and oil immersion cooling by using computational fluid dynamic techniques.
7. To enhance the performance of Raspberry Pi server with the use of heat sinks during the oil immersion cooling, for achieving high power output.

Chapter 2

Literature review

2.1 Introduction

The main idea behind this research is to find out a methodology for immersion cooling using mineral oil and to increase the operational efficiency of the Raspberry Pi server when immersed in oil. The main focus is on the optimum cooling of the CPU, when it is overclocked. These components form one of the most important ones in analyzing the material compatibility when brought in contact with mineral oil. The study focuses on developing a methodology that would best fit for oil immersion. The main idea is to build a body of knowledge to help industry make more informed regarding mechanical reliability of IT equipment in mineral oil immersed systems. The goal is to develop a testing procedure for evaluating the reliability of electronic packages and components when immersed in mineral oil. This chapter gives a brief idea about various cooling systems, data center, high end servers and their major components.

2.2 Components

Typical components of the Raspberry Pi server includes PCB board, ports such as USB, HDMI, LAN, Micro USB, A/V i/o, Ram and CPU. These components form the basis of the server for its application. The material used for the manufacturing of the server varies. For instance the PCB board is made up of FR4 material. Ports which carry power dissipation of about 0.1W are made up of stainless steel. The RAM having the power dissipation of about 0.5W is made up of silicon. The CPU too is made up of silicon material. These material when immersed into the oil, gives the reliability of various components for their application.

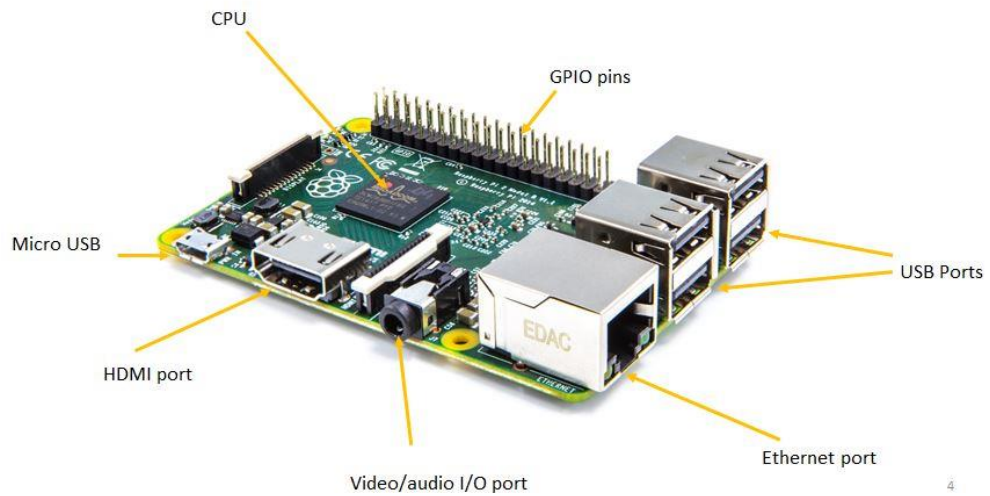

Figure 2.2 Components of Raspberry Pi server

2.3 Heat Transfer overview

For the ideal case, heat is transferred by radiation and convection to tubes via conduction through walls and forced conduction from internal wall. Depending on the amount of heat transferred with or without phase change, the fluid flow could be laminar or turbulent. With the change in the market trend and increased amount of computing capacity with decreased server size, air cooling is just insufficient to cool the server effectively. In the latter case with the addition of Heat sink to the server, the heat transfer capacity significantly changes. So for the ideal case the equation which governs the heat transfer is represented as,

$$Q=UA\Delta T$$

Where , Q is heat transferred in unit time

U represents overall heat transfer coefficient

A represents surface area

and ΔT is temperature gradient between the source and the sink

Chapter 3 CAD Modeling

3.1 Introduction

Since the Modeling of Raspberry Pi server needs to be as accurate as possible for obtaining accurate results, great amount of care needs to be taken for replicating the server by creating the CAD model.

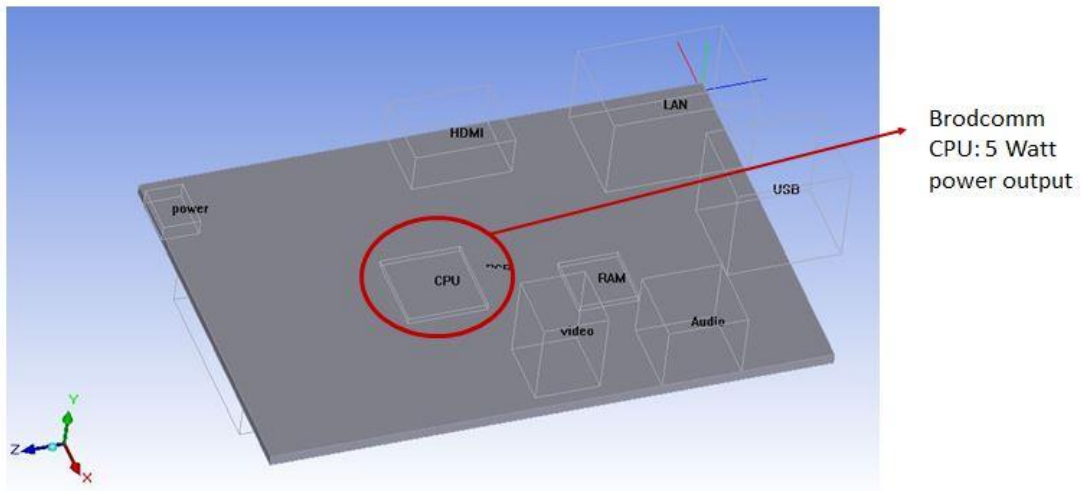

Figure 3.1 Raspberry Pi Cad model

3.2 Component size

CAD Model

Component	Length(mm)	Width(mm)	Height(mm)
PCB	56	85	1.6
cabinet	100	150	20
LAN	15.4	21.8	13
USB	13.25	17.2	15.3
Audio	11.4	12	10.2
RCA Video	10.0	9.8	13
SD Card	27.8	19	5
Power	7.6	5.6	2.4
HDMI	11.4	15.1	6.15
Broadcom CPU and GPU	12	12	0.85
GPIO	5	33.2	0.001
RAM	9	9	0.85

Figure 3.2 Cad model dimensions

Several components need to be taken as per the original dimensions from the Raspberry Pi server model, in order to get an accurate result. General parameters such as length, width and height are given appropriate dimensions. The above table shows the diagram of the CAD model which is being generated.

The condition for the air cooling of the server is as given below,

- Cabinet Opening is the inlet. The ambient conditions are as follows:
 1. Velocity – 1 m/s
 2. Temperature - 20° C
 3. Pressure – 1 atm
 4. Fan flow rate – 2118 CFM
- Power Conditions:
 1. CPU – 5 W
 2. RAM – 1 W
 3. LAN, SD CARD, AUDIO, VIDEO – 0.1 W

3.3 Air cooling

Now for the case of air cooling, on performing the analysis of temperature vs velocity parametric study, it can be seen from the diagram that, the air velocity from 0 to 1 m/s has significant impact on the temperature reduction on the server. The temperature drops up to 75 °C. Now it is to be noted that from 1 m/s to 2 m/s air velocity, there isn't any significant impact on temperature. Thus the air parametric study shows that, there is not much necessity to increase the air velocity form 1 m/s to 2 m/s, as there isn't any significant change in the temperature. The graph showing the air velocity parametric

study is shown in the below graph.

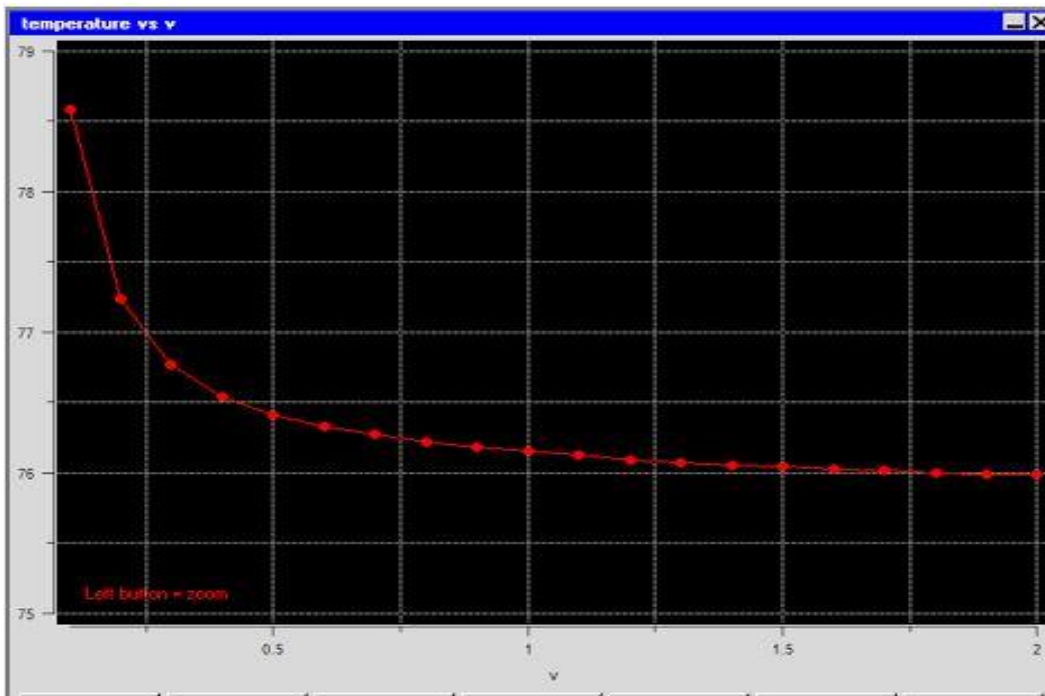

Figure 3.3 Air-velocity parametric study

3.4 Analysis of Raspberry Pi in Air without heat sink

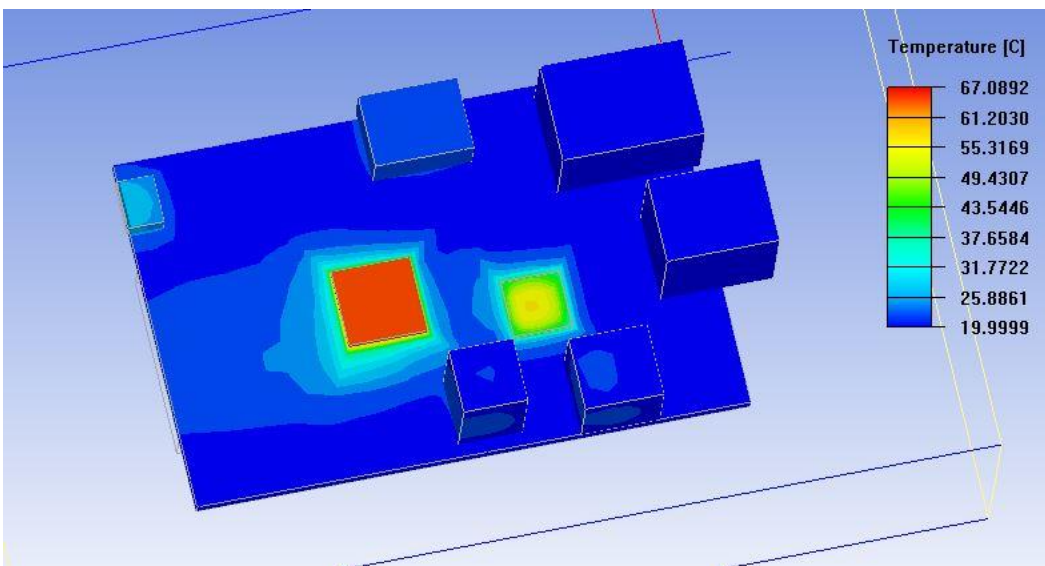

Figure 3.4 Thermal image of Raspberry Pi server in air without heat sink.

As seen in the above analysis study, it could be observed that, the CPU temperature has been raised to 67.08 °C. Also an important thing to note is that, the CPU Air side Heat dissipation is 4.34 W. CPU PCB side Heat dissipation becomes 0.66 W. Also the mesh sensitivity analysis of the study shows that with the increasing number of nodes, the accuracy of temperature increases, for instance for 13360 nodes the CPU base temperature is 65.02 °C, while increasing the nodes to 20235, the temperature output is 65.30 °C.

3.5 Heat Sink

With the use of Heat sink, an easy cooling solution could be achieved on the server. Because of its component assembly, it is ideal for heat transfer from air or liquid material and it is able to achieve this function by usage of its fins. The factors mainly affecting the performance of the Heat sink are velocity of air or fluid, the design of its fins, material property.



Figure 3.5 Heat sink

The above diagram shows the heat sink geometry being designed in the CAD model. The dimensions which are taken to design this Heat sink is shown hereby.

The foot print of the Heat sink is taken as 13X14 mm. The base height is taken as 0.37 mm. The Fin height is taken as 5mm. Number of fins are taken as 10. Finally aluminum material is chosen for this Heat sink. The reason for taking 10 fins is because of its effectiveness with cooling, which is obtained from the experimental data.

3.6 Thermal image of Raspberry Pi with Heat sink.

As seen in the below analysis study, it could be observed that, the CPU temperature gradually drops from 67.08 °C to 50.10 °C, which is almost 24% heat reduction. As the CPU base temperature drops to 50.01 °C, the CPU PCB side heat dissipation becomes 0.19W. The CPU Air side Heat dissipation becomes 4.81W. The Ram base Temperature reaches up to 42 °C.

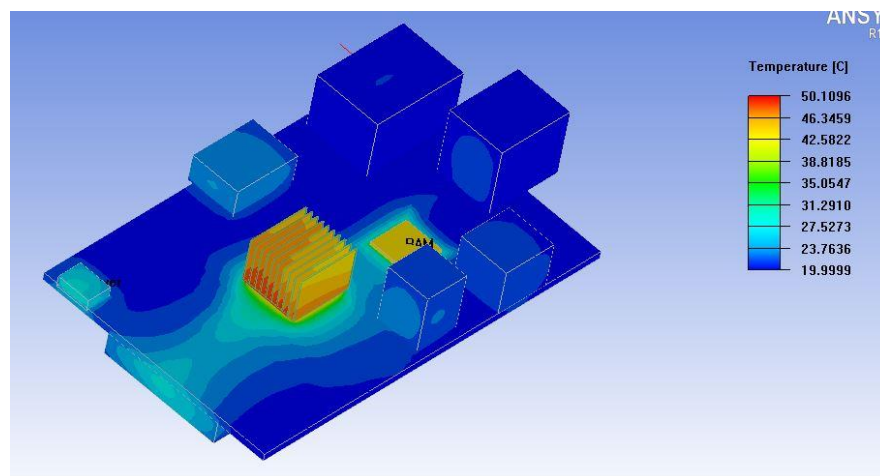

Figure 3.6 Thermal image of Raspberry Pi server in air with heat sink.

- Thus it is observed that the Heat sink rapidly increases the cooling efficiency. The number of fin count is effective until 18, in our case the optimum value is 10. So it can be concluded that from 0.1m/s to 1m/s the base temperature drops rapidly, but after 1m/s effect of convection is almost same, hence there is no meaning to further increase speed for raspberry pi's cooling.

Chapter 4

Oil immersion cooling

4.1 Introduction

Mineral oil has been used in immersion cooling because it is not hazardous and transfers heat almost as well as water. Since water is an electric conductor material that could damage the components. Mineral water is not electrical conductor but is not cost effective either. Water can damage the components and can cause corrosion on PCB layers and other critical components. On the other hand, mineral oil is electrically nonconductive and is economic in monetary terms. Also the mineral oil has more specific heat than water and air.

4.2 Properties of mineral oil compared to air

Property	Mineral Oil	Air
Density	849.2 kg/m ³	1.225 kg/m ³
Specific heat	1680 J/Kg K	1008 J/Kg K
Prantl Number	138	0.7
Conductivity	0.13 W/m K	0.001 W/ m K

Figure 4.2 Mineral oil and air comparison.

As it can be seen from above table, it is evident that the density of Air is much less compared to mineral oil and so is the heat carrying capacity. It can be interpreted that Mineral oil certainly has higher heat carrying capacity compared to air, as seen from the table. Since mineral oil has more viscosity it would help to pass itself throughout the server. Also immersion cooling helps to reduce noise as it is a closed system and thus helps in reducing exposure to dust and dirt.

4.3 Mineral oil Parameters

The velocity for the mineral oil is 0.0015m/s, its temperature is 20 °C and the mass flow rate is maintained at the rate of 4.2 $\mu\text{m}^3/\text{s}$. These are the input parameters of the mineral oil. CPU power on 144 mm^2 footprint is 0.1 to 0.5 w in normal operating condition. For high processor applications and RAM requirements 1 W power dissipation can be controlled by forced air cooling. For supercomputing use, servers have to take above 5 w capacities which are impossible on small SoC.

4.4 Analysis of Raspberry Pi in Oil without heat sink

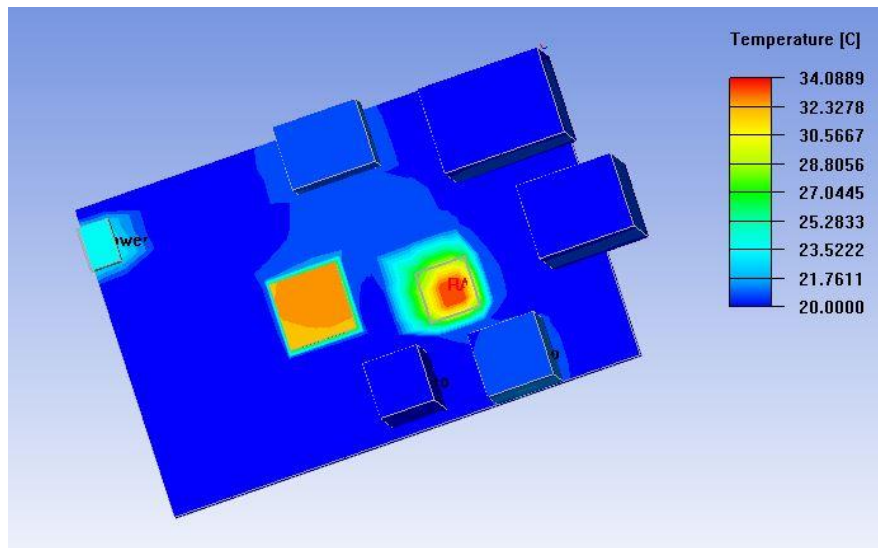

Figure 4.4 Thermal image of Raspberry Pi in Mineral oil without heat sink

As it can be seen from the above diagram that in the oil immersion cooling of server, the CPU base temperature reduces to 34.08 °C. The CPU oil side heat dissipation is 4.68W. The CPU PCB side heat dissipation 0.32W. The RAM base temperature is 34 °C. The pumping power required is 0.126 μW . Such are the output condition of the mineral oil. Thus it can be seen that Base Temperature reduces from 65 to 34° C which is 48% reduction. Heat dissipation from CPU sides is 4.68 W which is higher than air case. Pumping power is negligible as steady state condition is considered for the oil immersion case.

4.5 Thermal image of Raspberry Pi in mineral oil with Heat sink.

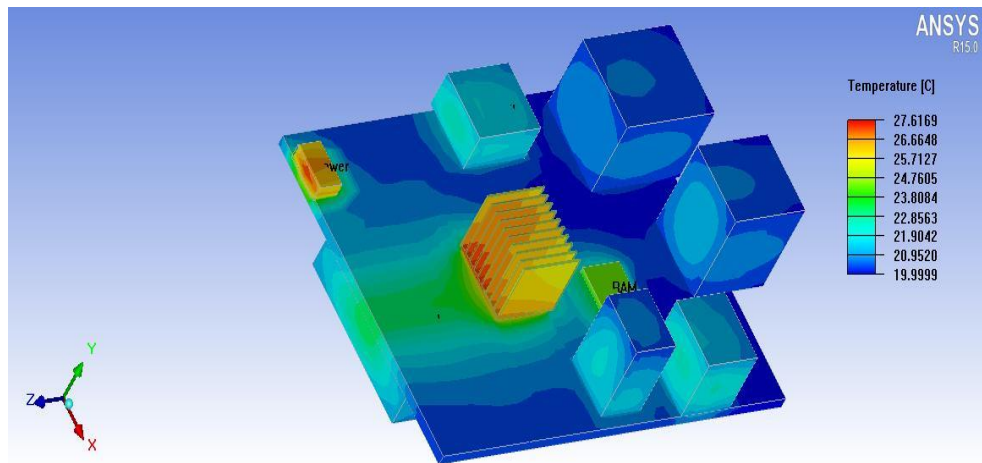

Figure 4.5 of Raspberry Pi in mineral oil with Heat sink

The presence of Heat sink rapidly increases the cooling efficiency. Also the CPU base temperature drops from 65 to 27° C which is 58% reduction. Number of fin count is effective until 18. Here the CPU base temperature drops to 27.61 ° C. The CPU PCB Side Heat Dissipation becomes 0.07 W. CPU Oil side Heat Dissipation becomes 4.93W. RAM Base Temperature becomes 23° C. Here the Pumping Power Required is 0.54 μ W. Hence it can be seen that with the help of heat sink the CPU temperature drops, hence it gives a better cooling on the server.

4.6 CPU base temperature vs Power

The CPU base temperature rises exponentially with the increase in power requirement. It can be seen that from 22° C it rises up to 82° C. The rise in temperature is due to th increased power requirement in the CPU. With each system upgrade, CPU cooling and overall thermal management will get improved. The graph below shows the increase in temperature with the power output requirement. An investigation in this research shows that in both the air-cooled and immersion cooled cases, the cooling framework is coordinated precisely to the load.

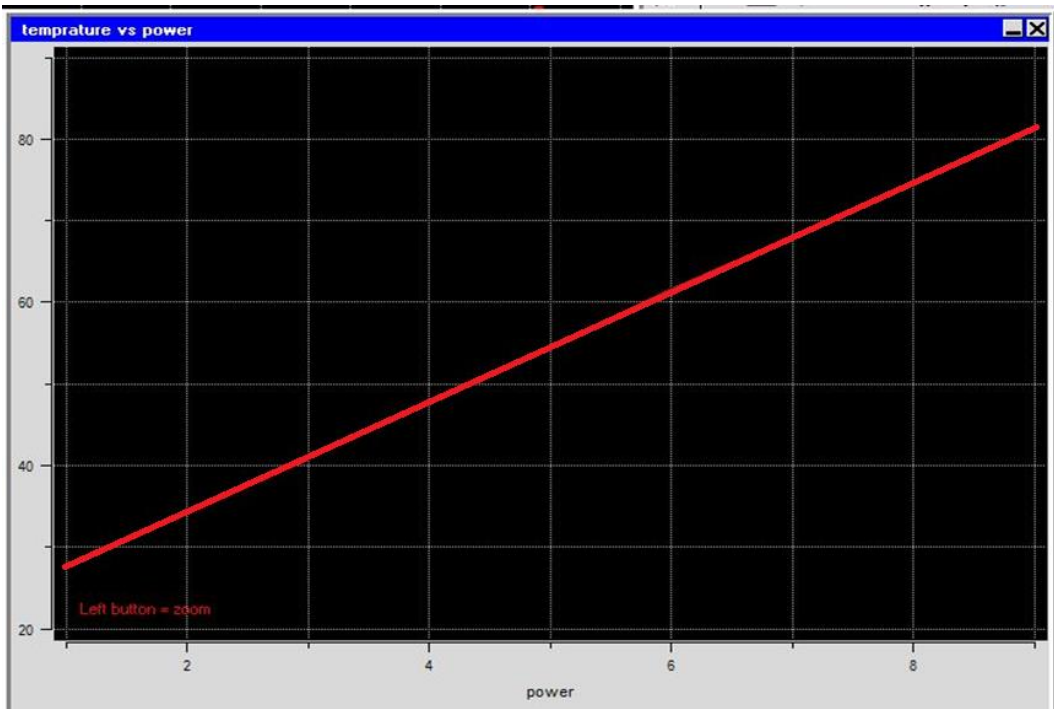

Figure 4.6 CPU base temperature(°C) vs POWER

Chapter 5

Immersion cooling v/s air cooling

5.1 Introduction

There is a general guideline used for cooling of air necessary for the server. One ton of refrigeration is approximately equal to 12,000 British heat units every hour. Given that 1 kilowatt-hour is proportionate to 3,412 British heat units, it is evident that a large amount of refrigeration will cool a heap of 3,517 W, or around 3.5 kW. Settling the mass flow heat exchange mathematical statement above with this data yields an adjustment in temperature of 15°C. Any individual who has remained in the "hot aisle" straightforwardly behind a rack of servers will realize this principle of the thumb is confirmed. The amount of the heat exchange with this statement can be used to confirm the general rule of Data center. Air is supplied from a computer room air conditioning (CRAC) unit in a normal data center at standard temperature.

5.2 Air cooling v/s oil flow

Since water is a conductor of electricity we just cannot dunk the whole computer into the server, as it might short circuit with the components. Mineral oil, then again, has been utilized by many electrical utilities to cool electrical force dissemination equipment, for example, transformers and circuit breakers, for several years; however it has one immense point of preference over water—it is an electrical insulator. So the risk of short circuit is drastically reduced because of this property. While water does not have the heat limit over mineral oil, regardless of it the mineral oil holds more than thousand times more heat than air. In a flawlessly arranged server farm, where the measure of air blown or oil pumped is facilitated absolutely to the warmth stack, the essentialness required to blow air is five times that required to pump oil for the same total of warmth evacuated. In reality, the measure of air traveled through a server ranch is fundamentally more than that

required to satisfy the heat. This is a result of the way that not the majority of the air blown into a server farm experiences a PC before it returns to the CRAC unit. Since the air is not ducted clearly to the PCs' air confirmations, it is permitted to locate its own specific path back to the CRAC unit, which is routinely over, around, or by and large not through a server rack. As we will soon see, it is a great deal less requesting to facilitate the method for oil and to pump just the ideal measure of oil to satisfy a given gear heat load. In this way, the essentialness required to course oil can be more than ten times not precisely the imperativeness required to stream air.

5.3 Advantages notwithstanding effectiveness of immersion cooling

Despite effective use of cooling liquid and the side advantages tended to above, there is another purpose important to submersion cooling—server thickness. In a space where the temperature is advancing from time to time in view of burden changes, this distinction in CTEs, over the long haul, lead to mechanical breakdowns on the circuit load up. Oil submersion diminishes this issue by making a temperature-stable environment.

One of the advantages of submersion cooling is a direct result of the way that the structure is expected to keep up an unfaltering temperature inside the tank. Since the pump is changed to keep up a set point temperature not identified with the adjustments in server workload, the servers live in an isothermal area. One reason for circuit board breakdowns is a direct result of the bungle in the coefficients of warm extension, or CTEs. The CTEs for the silicon, metal, tie, plastic, and fiberglass used as a part of a circuit board are all diverse, which suggests that these materials amplify and contract at various rates in view of temperature changes.

The other side advantage is server cleanliness. Air-cooled servers are essentially server farm air cleaners. While server farms are for the most part cleaner spaces, there is still some dust and soil present. Remembering, a normal server rack is drawing in a broad office space overflowing with air every minute. Any dust or soil in that air tends to gather in the undercarriage of the servers.

The last side advantage of liquid immersion cooling is no commotion for all intents and purposes. Submersion cooling structures make basically no disturbance. This is not a lesser advantage, the same number of front line air-cooled server farms work close or over the Occupational Safety and Health Administration's appropriate purposes of repression for listening to security.

5.4 Immersion cooling using less energy and infrastructure

5.4.1 Framework – air cooling

Cooling air is for the most part supplied in a PC room with CRAC units. CRAC units are determined to the room raised floor and blow cool air into the under-floor plenum. This cool air then enters the PC room through permeable floor tiles that are set before racks of PCs. Warmed exhaust air from the PCs then does an inversion to the most surprising reason for the CRAC units where it is pulled in, cooled, and blown back under the floor. With a specific choosing goal to cool the air, CRAC units as a rule utilize a chilled-water twist, which recommends that the PC room needs a wellspring of chilled water. The chilled water (routinely 45–55°F) is supplied by the server ranch chiller plant. At long last, the PC room warmth is depleted to the environment outside generally by technique for evaporative cooling towers. The takeaway here is that there is a huge measure of unreasonable, essentialness hungry base required to make and scatter cool

air to keep PCs in a server farm cool. A considerable measure of this system is not required for submersion cooling.

Oil-immersion structures in like manner need to expel heat, moreover, one path is through the usage of an oil-to-water heat exchanger; this suggests oil-drenching systems, as CRAC units, require a wellspring of cooling water. The huge distinction, nonetheless, is that CRAC units need 45–55°F water; however, oil-submersion systems can work with cooling water as warm as 85°F. Since oil-drenching structures can work with warm cooling water, they can misuse diverse detached warmth sinks, including radiators, geothermal wells, or close-by conduits.

5.4.2 Fan power

Servers that are cooled in an oil-inundation system don't require cooling fans. This conviction alone suggests that drenching cooling requires about 10% less vitality than air cooling. Inside server fans, in any case, are not by any methods the main fans required for air-cooled PCs. CRAC unit fans are moreover imperative to give nippy air all through the server ranch and present it to the channel side of the server racks.

5.5 Immerging technology

As hardware enhanced and as PCs got to be littler, air cooling turned into the standard. Chilling down unfathomable volumes of air that could be blown over the hardware works where electronic densities are still moderately low and where vitality costs are sensible. Much building work has enhanced warmth exchanger plan at the CPU level, yet outline issues still happen as hardware densities are pushed.

Increments in thickness alongside sharp increments in vitality costs have constrained numerous IT stars to take a gander at how wasteful existing cooling practices

are. The larger part of server farm proprietors are examining approaches to spare vitality while keeping up satisfactory cooling using more focused on air course utilizing computational liquid elements (CFD) and warm imaging. In any case, direct cooling through water use in the server farm is raising its head once more.[54]

5.6 Air cooling still popular, but has flaws

Air cooling's issues are turning out to be more evident. It's simply not great as a warmth exchange medium. As server farm gear has expanded in thickness, the utilization of huge fans has diminished due to an absence of space; so has the ability to move the huge volumes of air required through the hardware. Being a gas, air has poor warmth conductivity, so additional methods are required to exchange the warmth from its source into the air itself. Accordingly, blades must be connected to problem areas to augment the surface range accessible for warmth exchange far from the gear.

The measure of vitality required to chill down air to required temperatures and to move it around and through the server farm is turning out to be fairly costly. In spite of the fact that water might be the most financially savvy path forward, today it's still dominatingly an optional source.

Another method for proficiently utilizing water to chill air is water-side economisers, which are finding expanding use to either supplant or supplement standard PC room ventilating (CRAC) units so as to lower vitality costs.

Other server farms are taking things somewhat further. For example, Google is utilizing ocean water cooling for its new server farm in Finland, while PlusServer, a German association, is building another server farm in Strasbourg that will utilize ground water at an altered 12 degrees to 14 degrees Celsius as food water for cooling air in the server farm.

Other comparable methodologies incorporate falling window ornament evaporative cooling (a technique where air is constrained straightforwardly through a falling drapery of water and cooled because of evaporative vitality trade) in hot atmospheres and in addition direct stream water cooling in icy atmospheres.[54]

5.7 Liquid cooling vs air cooling

Water has somewhere around 50 and 1,000 times the ability to evacuate heat than air and can in this manner be much more powerful to cool hotspots on the off chance that it's designed and executed in the right way.

With centralized computer and certain moderate sized PCs that utilized water cooling as a part of the 1970s, '80s and '90s, this water was go through copper channels at positive weight and used to cool hotspots as required, particularly at the CPU. Most different gadgets inside the PC kept running at a low temperature and in an open space to be cooled through low-weight wind streams sustained by chiller frameworks. In any case, if a water spill happened, the positive weight would compel water out into the heart of the PC, and, tragically, water and the internal parts of a PC don't blend that well.

Nonetheless, water cooling has developed to a point where spillage ought not be the issue that it once was. For instance, server farms can utilize back entryway heat trades as independent frameworks, such that if there is a break, it is all contained inside the framework with no danger of the water getting to any electrical hardware. Here, the back of a 19-inch rack is supplanted with a warmth exchanger through which chilled water is pumped. Indeed, even as an aloof framework (i.e. no constrained air utilized), IBM and others guarantee that such a framework can expel 60% of the warmth from a 33 kW high-thickness rack. Utilized inside an independent fixed rack, back entryway heat

exchangers can give extensive investment funds against putting set up new CRAC units alongside focused cooling.

Another methodology is to utilize very focused on water cooling, in which metal cushions (by and large copper or even gold-plated copper for extra warm efficiencies) with miniaturized scale channels are utilized to supplant the standard cooling blades utilized on CPUs. Immaculate water (no broke down solids or gasses) is gone through the miniaturized scale channels, expelling warm straightforwardly from the CPUs; frequently it can be utilized as a part of different parts of the working as yield at temperatures that are sufficiently high to warmth water.

In spite of the fact that CPU-based water cooling is not especially new in itself, what is new is that frameworks are currently keep running at negative weight, so that the water is sucked round the framework, instead of pumped. In the event that the framework builds up a hole, air is sucked in, as opposed to water spilling out. Sensors screen the framework persistently so that in the event that this happens, chairmen are educated promptly and can make medicinal move.[54]

Chapter 6

Initial trial and proposed methodology

6.1 Introduction

The main focus in here is to perform an initial trial experiment wherein the environmental conditions used for air cooling are applied to oil immersion cooling. The results/ outcomes are noted down and those outcomes are compared to that of the air cooling. Here the experiment which is conducted by Liquid cooling solutions is shown here, which shows both air and oil immersion cooling.

6.2 Initial trial

Objective is to determine the effect of air cooling on Raspberry Pi server without any extra provision of cooling materials. Here baseline CPU temperatures were measured with standard 5V input while unit was overclocked at 800MHz, 900MHz and 1000MHz respectively. The standard temperature which was maintained in the laboratory was 20°C throughout during the time of conduct of experiment. The submersion liquid was kept up at this same temperature amid inundation testing also. Estimations were recorded at gadget startup and in resulting 1-hour increases. CPU temperatures were measured for both air cooling and submersion cooling with overvoltage levels of 6V, 7V, and 8V connected amid 3-hour periods for every test, individually. Overclocking velocity of 1000MHz was kept up for the term of the overvoltage testing.

CPU temperatures were obtained via the Raspberry Pi unit itself by using the following command sequence upon login:

```
/opt/vc/bin/vcgencmd measure_temp  
ENTER
```

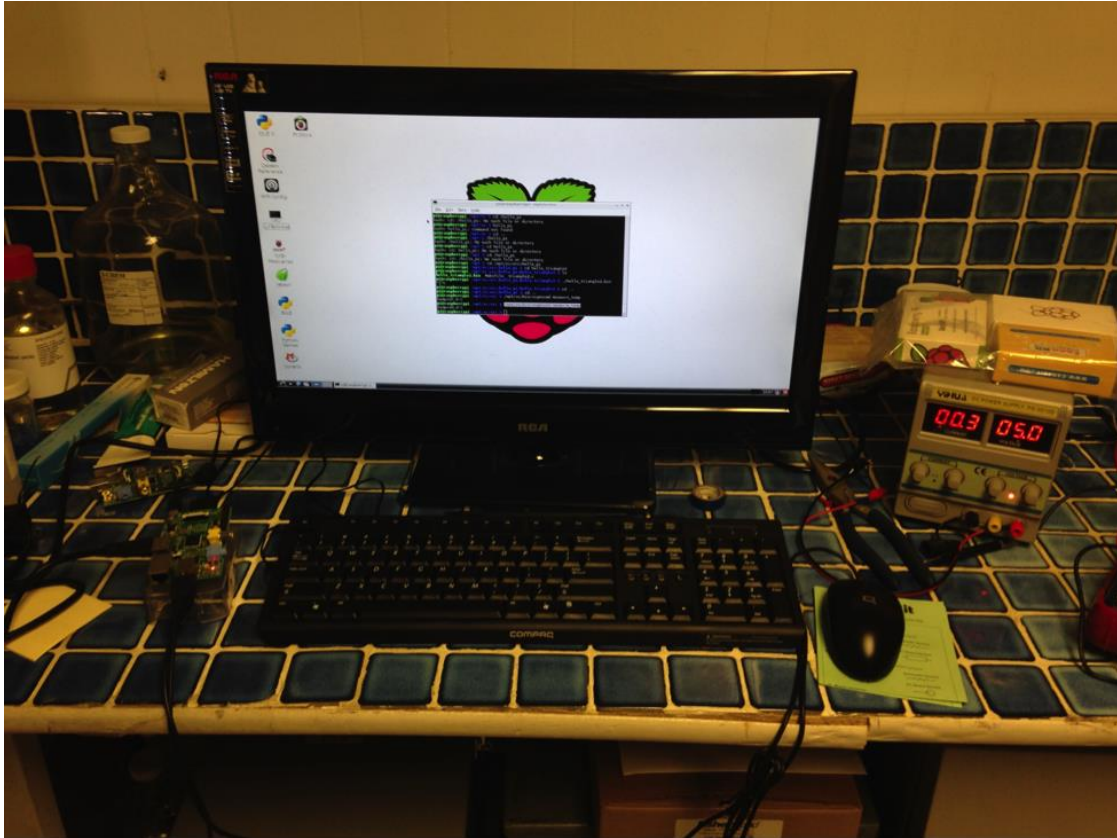

Figure 6.2 Air cooling of Raspberry Pi

As seen in the figure 6.1, the initial trial consisted of applying the above mentioned conditions to the Raspberry Pi server during the open computing.

6.3 Results/outcomes

The thermal image of Raspberry Pi server is shown in below diagram, where air cooling is used for the Raspberry Pi server.

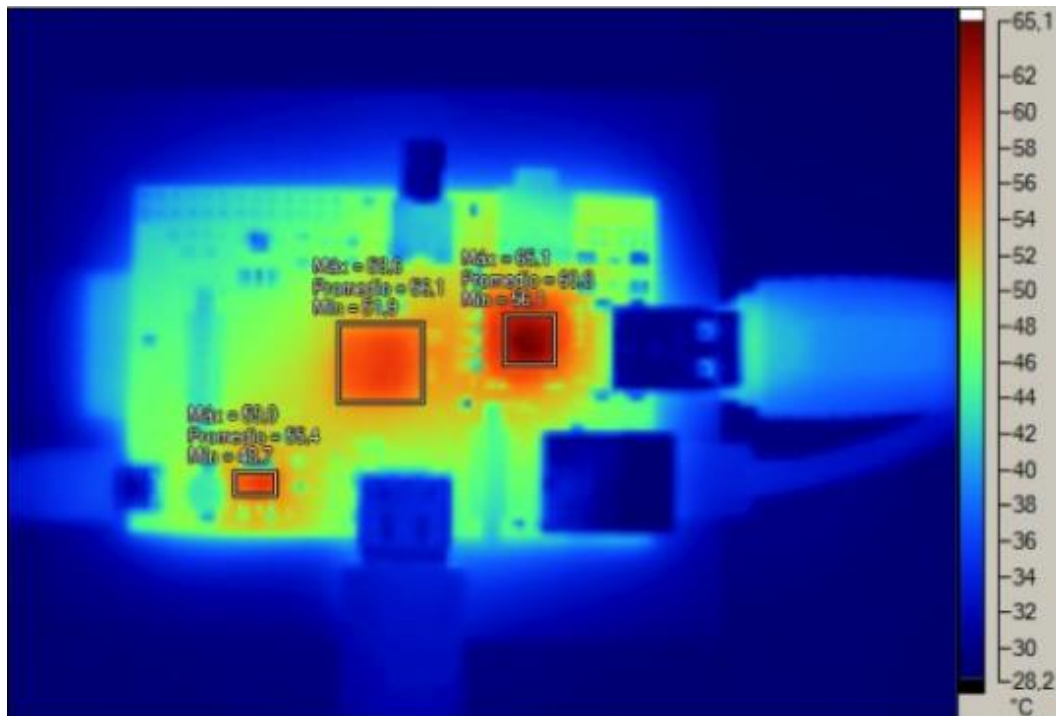

Figure 6.3 Thermal Image of Raspberry Pi Model B

The thermal image figure 6.2 demonstrates that the CPU is one of the biggest warmth emitters when the Raspberry Pi is running at ordinary limit. Amid this study, we concentrated solely on CPU temperature estimations.

The Raspberry Pi is ordinarily fueled by 5V and 1-1.5A and can be overclocked to a most extreme 1000MHz, likewise with other registering gadgets, the Raspberry Pi has a tendency to overheat when overclocked or when overabundance voltage is connected to the gadget. The greatest working temperature for the Raspberry Pi CPU is 85°C. As this trial was directed, the CPU never surpassed this temperature. The graph depicts:

6.4 Raspberry Pi immersion in oil

The Oil immersion of Raspberry Pi shows reduced temperature, on the CPU base.

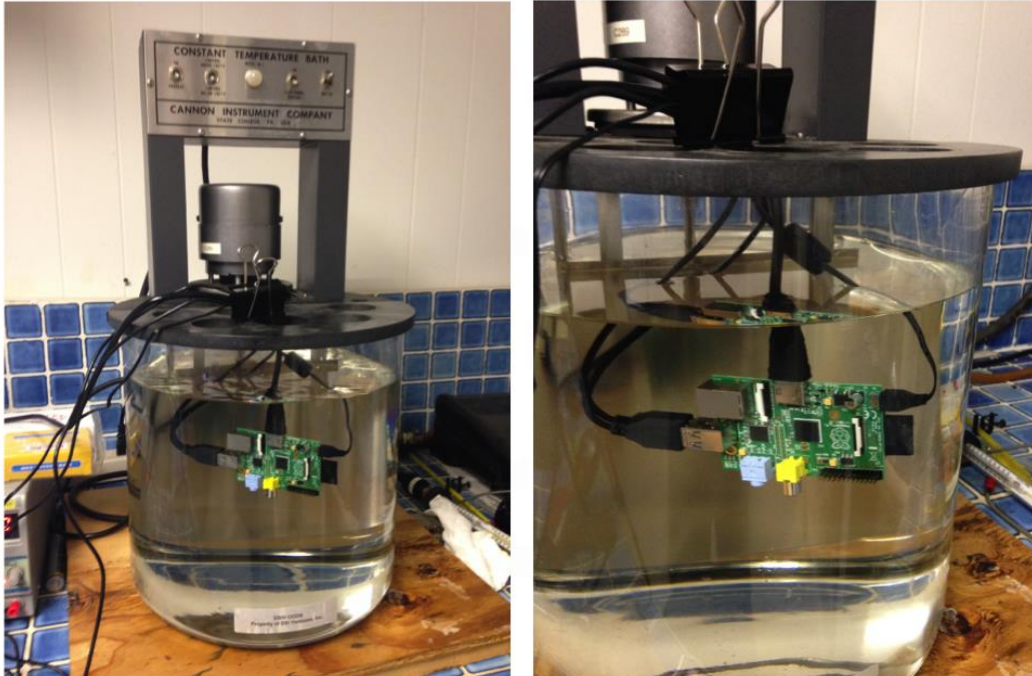

Figure 6.4 Raspberry Pi immersed in Opticool Fluid and powered up for temperature measurements.

Amid 36 hours of testing, the gadget kept up satisfactory operation however when 7-8V was connected to the unit, operation turned out to be to a great degree unsteady. This happened amid both air and fluid cooling testing. This is likely because of an impediment of the CPU utilized for this board, however in view of these discoveries; on-board processor force of the Raspberry Pi can be expanded if an all the more intense CPU were incorporated into the configuration and joined with fluid inundation cooling.

6.5 Water cooling of Raspberry Pi server

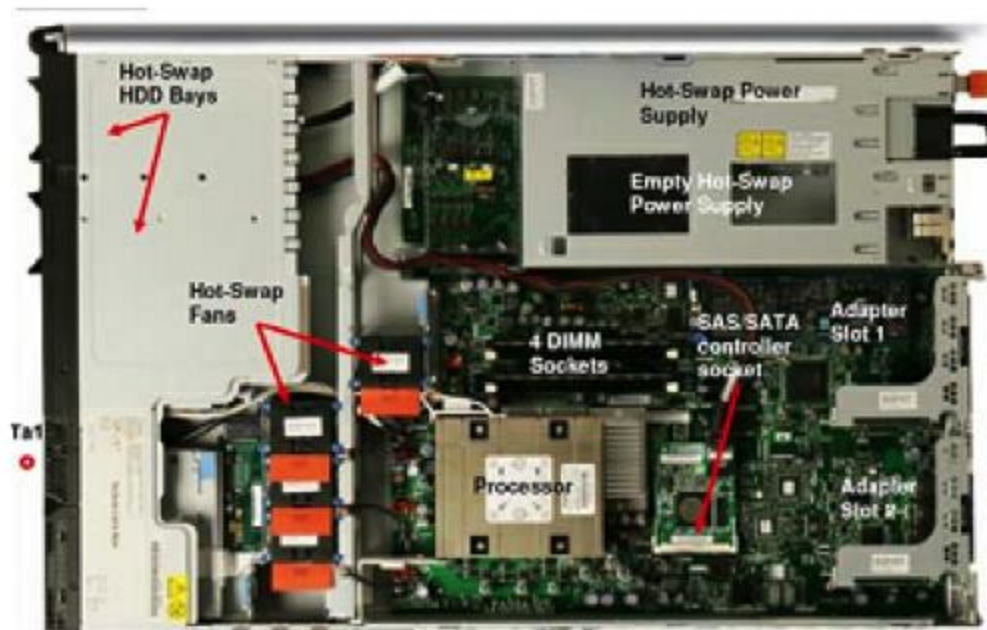

Figure 6.5 Cooling system for IBM power series server [52]

Contrasted with air, water-cooling can give just about a request of size diminishment in warm resistance because of the higher warm conductivity of water. As a result of higher thickness and particular warmth of water, its capacity to assimilate heat as far as the temperature ascends over the coolant stream is roughly 3500 times that of air.

Although this method has been developed by IBM, it is not very practical to use it, because it uses mineral water which is very costly. [52]

6.6 Experimental result

During baseline testing, 5V was applied to the Raspberry Pi during 3 overclocking tests.

Results were as follows:

	Startup	1-Hour	2-Hour	3-Hour
700 Mhz	34.2° C	39.0° C	47.6° C	48.3° C
900 Mhz	36.3° C	48.2° C	48.7° C	51.9° C
1000 Mhz	37.4° C	54.1° C	54.6° C	58.4° C

Figure 6.6 Output data from experiment[52]

As appeared in figure 6.4 the most extreme CPU temperature at 1000MHz following 3-hours of operation was 58.4°C. Next, temperatures were recorded as overvoltage was connected to the unit. Most extreme overclocking of 1000MHz was kept up all through. The outcomes are recorded and charted as demonstrated as follows.

6.7 Experimental outcome graph

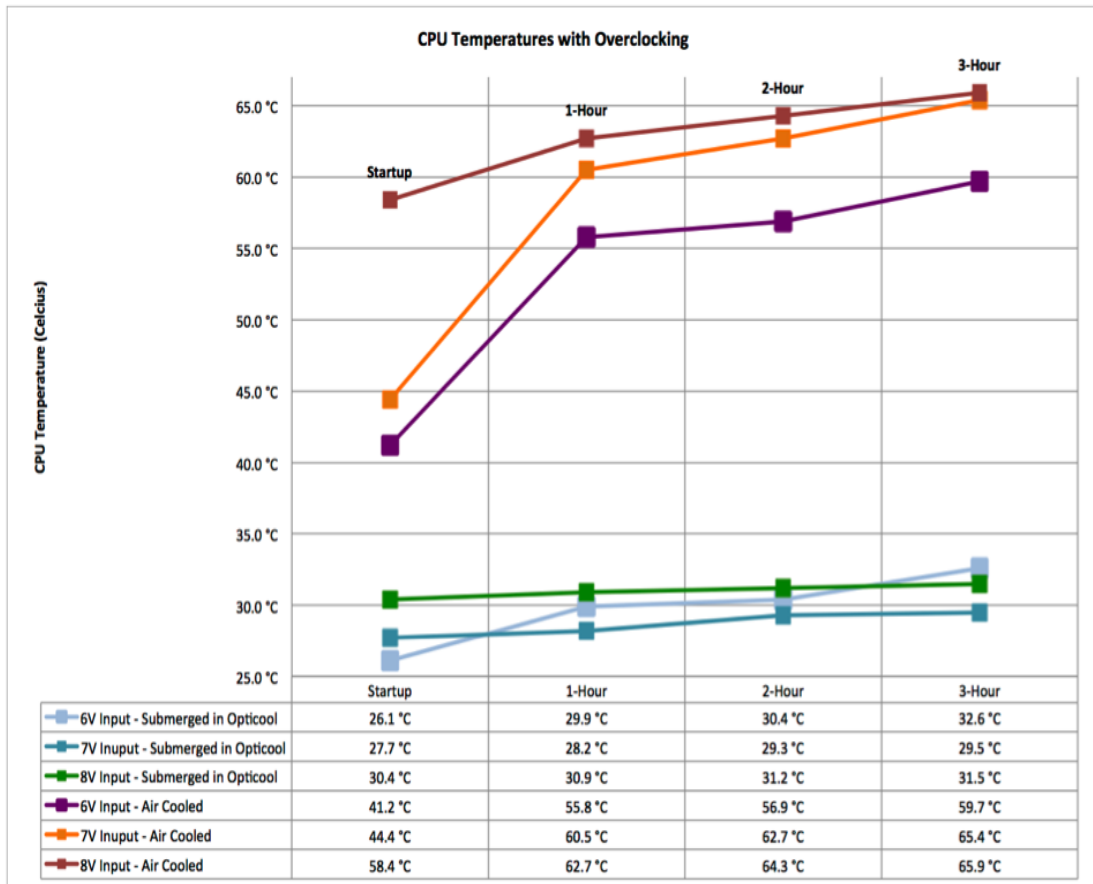

Figure 6.7 CPU temperatures with Overclocking[52]

The above graph is just a hypothesis which explains, change in CPU temperature with overclocking. The above difficulties were postured and the conceivable results and outcomes were speculated which reasoned that the ecological conditions that are connected to oil can't be connected to air as the slope rate and abide time of both oil and air are distinctive where air takes less time to go from least temperature to greatest temperature and though oil takes more opportunity to get warmed up and the stay time is more for oil when contrasted with air. Thus it was finished up from the test was that same natural conditions can't be connected to oil inundation cooling. [53]

6.8 Comparison of experimental and CFD work

	CPU Base Temperature			
	Air cooling with heatsink	Air cooling without heatsink	Oil cooling with heatsink	Oil cooling without heatsink
CFD data	50.10 °C	67.08 °C	27.61 °C	34.08 °C
Experimental data	55.08 °C	65.90 °C	27.7 °C	32.60 °C

Figure 6.8 Comparison of CFD results vs experimental results

The above result shows that there exist significant similarities in the results obtained from CFD analysis vs the experimental data. Thus it could be verified that the proposed methodology of oil immersion cooling with significant overclocking could be achieved, while maintaining the low temperature on CPU.

Hence it can be concluded that with the CPU overclocking, the Raspberry Pi sever can achieve upto 9W power output, while maintaining lower constant temperature. Also the comparison of experimental and CFD work shows a similarity, which further supports this research work.

Chapter 7

Future Study

1. To give the pattern of quickened debasement of segments for oil cooled server farms.
2. Change in the properties of Mineral oil because of Thermal Overstress.
3. To permit the parts to experience warm overemphasize and expelling them from the mineral oil in customary interims which is warm cycling.
4. To approve the system and examine for more explores different avenues regarding distinctive ecological conditions.

References

- [1] webopedia.com
- [2] wikipedia.com
- [3] <http://www.fedtechmagazine.com> (4 Shades of Efficiency)
- [4] <http://blogs.technet.com> (Datacenter Architecture for Environmental Sustainability – “Green Datacenters”)
- [5] <http://data247.ru> (MONITORING SYSTEMS OF THE DATA CENTERS)
- [6] WWW.electronics-cooling.com (liquid cooling is back)
- [7] PacificGasandElectrical. HIGH PERFORMANCE DATA CENTERS. 2011 January; Available from: http://hightech.lbl.gov/documents/data_centers/06_datacenters-pge.pdf.
- [8] Barroso, L.A. and U. Hölzle, The datacenter as a computer: An introduction to the design of warehouse-scale machines. Synthesis Lectures on Computer Architecture, 2009. 4(1): p. 1-108.
- [9] WWW.http://energy.lbl.gov (Global Energy Use by Data Center Servers)
- [10] Rasmussen, N., Avoidable Mistakes that Compromise Cooling Performance in Data Centers and Network Rooms. White Paper, 2003. 49: p. 2003-0.
- [11] <http://www.cisco.com> (Power Management in the Cisco Unified Computing System: An Integrated Approach)
- [12] Shehabi, A., Energy Implications of Economizer Use in California Data Centers. 2008.
- [13] Hannemann, R. and H. Chu, Analysis of Alternative Data Center Cooling Approaches. InterPACK paper. 1176.
- [14] Rasmussen, N., Avoidable Mistakes that Compromise Cooling Performance in Data Centers and Network Rooms. White Paper, 2003. 49: p. 2003-0.

[15] Bhopte, S., et al. Optimization of data center room layout to minimize rack inlet air temperature. 2005: ASME.

[16] Sharma, R.K., C.E. Bash, and C.D. Patel. Dimensionless parameters for evaluation of thermal design and performance of large-scale data centers. 2002: Citeseer.

[17] Wang, D. Cooling challenges and best practices for high density data and telecommunication centers: IEEE.

[18] Niemann, J., Hot aisle Vs. Cold aisle containment. APC white paper.

[19] Hartley, J., e Cool: Cold Aisle Containment, in International Conference on Sustainable Data Center Design and Operation. 2011, University of Leeds: Leeds.

[20] HOT AISLE CONTAINMENT COOLING SOLUTIONS. 2011.

[21] Rasmussen, N., Improving Rack Cooling Performance Using Airflow Management™ Blanking Panels. White Paper 44

[22] Hannaford, P., Ten cooling solutions to support high-density server deployment. APC white paper, 2006. 42.

[23] 2010 Best Practices for the EU Code of Conduct on Data Centres. 2010.

[24] Cho, J., T. Lim, and B.S. Kim, Measurements and predictions of the air distribution systems in high compute density (Internet) data centers. Energy and Buildings, 2009. 41(10): p. 1107-1115.

[25] ASHRAE-TC9.9. Thermal guidelines for data centre processing environments. 2011; Available from: http://ecoinfo.cnrs.fr/IMG/pdf/ashrae_2011_thermal_guidelines_data_center.pdf.

[26] Evans, T., Humidification strategies for data centers and network rooms. White Paper, 2004. 58: p. 2004-0.

[27] Accelerated thermal cycling and failure mechanisms for BG and CSP assemblies, Reza Ghaffarian, Jet Laboratory, California Institute of Technology

[28] D.C. Wright, 'Failure of Plastics and Rubber Products – Causes, Effects and Case Studies involving Degradation', Rapra Technology Report, 2001, ISBN:1-85857-261-8

[29] R.P. Brown, D. Kockott, P. Trubiroha, W. Ketola and J. Shorthouse, 'A Review of Accelerated Durability Tests', VAMAS Report No.18, Edited by R.P. Brown, Versailles Project on Advanced Materials and Standards, 1995.

[30] Doing more with less: Cooling computers with oil pays off, by David Prucnal, PE

[31] Shah, A., et al. Impact of rack-level compaction on the data center cooling ensemble. in Thermal and Thermomechanical Phenomena in Electronic Systems, 2008. ITherm 2008. 11th Intersociety Conference on. 2008: IEEE.

[32] Greenberg, S., et al., Best practices for data centers: Lessons learned from benchmarking 22 data centers. Proceedings of the ACEEE Summer Study on Energy Efficiency in Buildings in Asilomar, CA. ACEEE, August, 2006. 3: p. 76-87.

[33] Data Center Power and Cooling -
http://www.cisco.com/c/en/us/solutions/collateral/data-center-virtualization/unified-computing/white_paper_c11-680202.html

[34] AL-Moli, A.M., AIR FLOW MANAGEMENT INSIDE DATA CENTRES, in Mechanical Engineering. 2013, University of Leeds: Leeds. p. 211.

[35] Yang, C.-Y., et al. An in-situ performance test of liquid cooling for a server computer system. in Microsystems Packaging Assembly and Circuits Technology Conference (IMPACT), 2010 5th International. 2010: IEEE.

[36] Tuma, P.E. The merits of open bath immersion cooling of datacom equipment. in Semiconductor Thermal Measurement and Management Symposium, 2010. SEMI-THERM 2010. 26th Annual IEEE. 2010: IEEE.

[37] Naidu, S. and V. Kamaraju, High Voltage Engineering. 2009: Tata McGraw Hill Education Private Limited.

[38] Lee, T.S., G.H. Son, and J.S. Lee, Numerical study on natural convection in three-dimensional rectangular enclosures. KSME Journal, 1989. 3(1): p. 50-55.

[39] He, Y., W. Yang, and W. Tao, Three-dimensional numerical study of natural convective heat transfer of liquid in a cubic enclosure. Numerical Heat Transfer, Part A: Applications, 2005. 47(9): p. 917-934.

[40] Frederick, R.L. and F. Quiroz, On the transition from conduction to convection regime in a cubical enclosure with a partially heated wall. International journal of heat and mass transfer, 2001. 44(9): p. 1699-1709.

185

[41] Holman, J., Heat transfer, 9th. 2002, McGraw-Hill. p. 335-337.

[42] Phan-Thien, Y.L., Nhan, An optimum spacing problem for three chips mounted on a vertical substrate in an enclosure. Numerical Heat Transfer: Part A: Applications, 2000. 37(6): p. 613-630.

[43] Chuang, S.-H., J.-S. Chiang, and Y.-M. Kuo, Numerical simulation of heat transfer in a three-dimensional enclosure with three chips in various position arrangements. Heat transfer engineering, 2003. 24(2): p. 42-59.

[44] Frederick, R.L. and S.G. Moraga, Three-dimensional natural convection in finned cubical enclosures. International journal of heat and fluid flow, 2007. 28(2): p. 289-298.

[45] Nada, S., Natural convection heat transfer in horizontal and vertical closed narrow enclosures with heated rectangular finned base plate. International Journal of Heat and Mass Transfer, 2007. 50(3): p. 667-679.

[46] Yucel, N. and H. Turkoglu, Numerical analysis of laminar natural convection in enclosures with fins attached to an active wall. Heat and mass transfer, 1998. 33(4): p. 307-314.

[47] PCB Basics - <https://learn.sparkfun.com/tutorials/pcb-basics>.

[48] thermo elastic properties of Printed Circuit Boards : effects of copper trace, HU Guojun, SMT electronics, Singapore, Goh Kim Yong Lvan Jing-en, Baraton, published in :Microelectronics and packaging conference,2009,EMNSPC, European, by IEEE.

[49] Design for reliability and sourcing of PCBs by Cheryl Tulkoff, Dr. viktor Tiederb.

[50] International confederation of thermal Analysis and Calorimetry(ICTAC), Nomenclature committee, recommendations for names and definitions in thermal analysis and calorimetry.

[51] Thick film and thin film resistors- a comparison, by Stackpole electronics Inc.

[52] <http://liquid-cooling.org/tag/raspberry-pi/>

[53] Kota venkata naga indu sravani, Development of a methodology and sample preparation toevaluate reliability of oil cooled data center.

[54] <http://www.computerweekly.com/tip/Water-cooling-vs-air-cooling-The-rise-of-water-use-in-data-centres>

Biographical Information

Dhaval Hitendra Thakkar was born in Vadodara, Gujarat, India in 1992. He received his B.E in Mechanical engineering from Gujarat Technological University, India in May 2014, and his M.S. in mechanical engineering from The University of Texas at Arlington in May 2016. He had been involved in number of projects related in area of electronics cooling techniques. His research includes immersion cooling method for data center servers and has been working for the Facebook research team. He joined EMNSPC research team under Dr. Dereje Agonafer in fall 2014 and been involved in projects related to packaging level to server level.