

THE PHOENIX BIRD REHABILITATION CENTER
CLEBURNE, TEXAS

by

THOMAS M. BODELL

Presented to the Faculty
The School of Architecture and Environmental Design
In Partial Fulfillment of the Requirements
for the Degree of

MASTER OF ARCHITECTURE

THE UNIVERSITY OF TEXAS AT ARLINGTON

May 10, 1984

INTRODUCTION

The Phoenix Bird Rehabilitation Center, presently of Arlington, Texas, is a non-profit corporation which is dedicated to the preservation of Texas avian wildlife. The Phoenix Center is currently engaged in acquiring land and donations for the construction of new facilities. Negotiations are under way for the acquisition of a site which is located near Cleburne, in Johnson County, Texas.

A preliminary site plan for the new facility was prepared by Professor James Turner's graduate landscape class, LARC 5674, during the Fall semester of 1982. Serving as the architectural consultant for the project, I worked closely with the landscape students to develop the site plan. My contribution to development of the site plan also included development of a preliminary design for the new architectural facilities.

The preliminary plan, as presented on December 13, 1982, was approved by the Phoenix directorship. Since that time, the scope of the project has been expanded and the possibility of acquiring a larger area of land is being considered.

It is the intent of this project to provide a comprehensive plan for the phased development of the new Phoenix Center, which will incorporate their expected requirements for the foreseeable future. The ultimate solution must be one which is realistic in terms of functional requirements and budgetary constraints, and which will provide a singular identity for the new Phoenix facility.

TABLE OF CONTENTS

INTRODUCTION	1
PROJECT DESCRIPTION.	2
Client Profile.	3
User Profile.	4
The Human User	4
The Avian User	5
Site Description.	7
DESIGN CRITERIA.	13
Programmatic Requirements	14
Square Footage Summary.	19
Functional Relationships.	23
Psychological Considerations.	25
Legal and Contextual Constraints.	27
Symbolic Parameters	28
Economic Parameters	29
Energy Issues	30
CASE STUDIES	32
Milford Reservation Environmental Center.	33
Flat Rock Brook Center for Environmental Studies	37
Botanic Garden Administration and Visitor Center	41
SITE ANALYSIS	45
APPENDIX A	50
Presentation Drawings	51-59
APPENDIX B	60
Comprehensive Examination	61-80
APPENDIX C	81
State Sanitation Guidelines	82-106

PROJECT DESCRIPTION

PROJECT DESCRIPTION

Client Profile:

The Phoenix Bird Rehabilitation Center

The Phoenix Center is the largest bird rehabilitation center in North Texas, and has been rapidly expanding during the last several years to become one of the largest facilities of its kind in the United States.

The directors of Phoenix Center are: George L. Stewart, Ph.D., a professor of biology at the University of Texas at Arlington; his wife, J. Breck Stewart; and James E. Doyle, M.D., a surgeon. The directors have a combined experience of more than 20 years in working with wild birds.

Services provided by the Phoenix Center include:

a) A rehabilitation program for injured birds.

Veterinary care and rehabilitation therapy for ill and injured birds are provided by the Center and, once the birds have recovered, they are released in their natural habitat.

b) Rearing of orphaned nestlings. In addition to being provided with proper diet, health care and shelter, the young birds undergo a training program which includes natural food recognition and development of hunting instincts in preparation for their release.

- 3) Captive breeding of threatened or endangered species. Offspring are trained and released to augment dwindling native populations.
(The Phoenix Center has recently launched a campaign to raise funds for the construction of a new bald eagle breeding facility, which is to be a part of the new Phoenix Center complex.)
- 4) Public Education. One of the Phoenix Center's primary purposes is to instill among the general public an awareness of the value and plight of our native wildlife. The Phoenix directors and volunteers present slide shows and hold seminars for adult and youth organizations, school groups, etc.
- 5) Research in avian biology, physiology, and diseases.
- 6) Habitat conservation. In order to protect undeveloped natural habitat from exploitation, Phoenix accepts donations of land in the Metroplex area, which they preserve in their natural state.

User Profile:

The Human User

Those people using the facility (excluding the Phoenix staff) will be persons visiting the Center as part of its

educational function. Visitors to the Phoenix Center will consist initially of residents of the Metroplex area. They will, therefore, have primarily urban backgrounds, and may possess only a casual acquaintance with Texas' native avian wildlife. The new Phoenix Center will serve an important function by reintroducing the urbanite to the natural environment, and by developing or reinforcing an appreciation for the value of Texas wildlife populations.

Access to the new Phoenix facility will be by appointment only. This eliminates casual passers-by, and allows for close supervision of visitors at all times. Members of various adult organizations, youth organizations, and school groups at all age levels will be visiting the facility, as well as other interested parties, such as potential donors and visiting environmental experts. It is expected then, that visitors will possess diverse backgrounds and education levels, and Phoenix's education facilities must be flexible enough to accommodate this diversity.

User Profile:

The Avian User

The Phoenix Center accepts birds, primarily of native species, which have been injured or orphaned, or those of threatened or endangered species which are suitable for their captive breeding program. These birds are entrusted to Phoenix's care by

various governmental agencies, such as the Federal Division of Fish and Wildlife, the Texas Department of Parks and Wildlife, local animal control agencies and zoos, as well as private individuals.

Almost all donated birds have been through a traumatic experience (injury or mishandling) and Phoenix's objective is to provide them with adequate health care and diet, as well as a sanitary and quiet environment. As the requirements for each species vary greatly regarding diet, space requirements and nesting habits, they will generally be provided with separate facilities. In addition, many raptor species exhibit a naturally antagonistic relationship with other raptors, and the siting of the enclosures must be such that close proximity or visual contact is avoided.

In general, all bird housing facilities will provide the same basic elements: a sheltered area from the weather; buffering from noise; provision of natural light and ventilation; protection from predators; and a diet consisting of their natural foods. It is important that all birds in their care do not become imprinted (accustomed to feeding and handling by their caretakers) so that they can eventually be released into an appropriate habitat.

Site Description

The site chosen by Phoenix for their new facility is located in Johnson County, Texas, approximately three miles west of the county seat of Cleburne. It is part of a parcel of land owned collectively by a local family. Parts of this parcel are currently under cultivation or grazing, and parts left in their natural state. The central portion of the site, along the Nolan River floodplain and the surrounding bluffs, is primarily virgin forest, and very valuable as wildlife habitat. The family owners, the Mayfields, wish to preserve this area in its present condition for the public enjoyment, while developing other parts for single-family housing.

The Mayfields were approached by the members of a graduate landscape class at the University of Texas at Arlington, LARC 5674, with the idea that part of their land could be utilized by Phoenix for their new facility. The owners were receptive to the idea, as were the directors of Phoenix, and the result was the creation of a master plan for the development of the entire parcel by the landscape students. The accompanying drawings were part of the students' presentation in December of 1982.

That portion of the site which was allocated to the Phoenix project was chosen for its natural sense of enclosure due to the surrounding topography and existing tree cover, its adjacency to natural wildlife habitat, and the presence of a man-made pond --one of Phoenix's requirements for the rehabilitation of waterfowl

and shorebirds. Low-density, single-family housing (3-4 ac/d.v.) borders the Phoenix site to the North, East and South, with the ecological preserve on the West side.

The high ground on the West side of the Nolan River, is presently utilized for agricultural purposes. The majority of this land is to remain in cultivation, with a portion to be set aside as a botanical research station and nursery. This area was also considered for establishment of a nature preserve headquarters for public use, which would include camping and a series of nature trails. The intent for this preserve is to act as a buffer and control center for the area adjacent to the Phoenix facility.

Included in the presentation drawings is a preliminary master plan for the development of the Phoenix property, for which the author served as a consultant. It is expected that this preliminary plan will serve as a rough guideline for the future siting of the buildings and other elements of the facility, insofar as the boundaries are not significantly altered at the conclusion of the actual lease agreement.



-9-

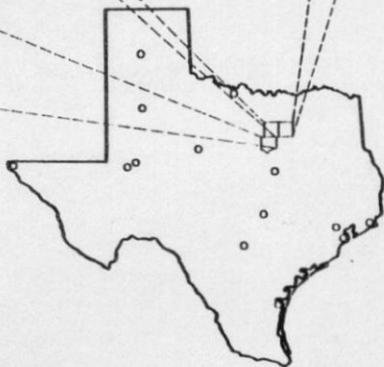
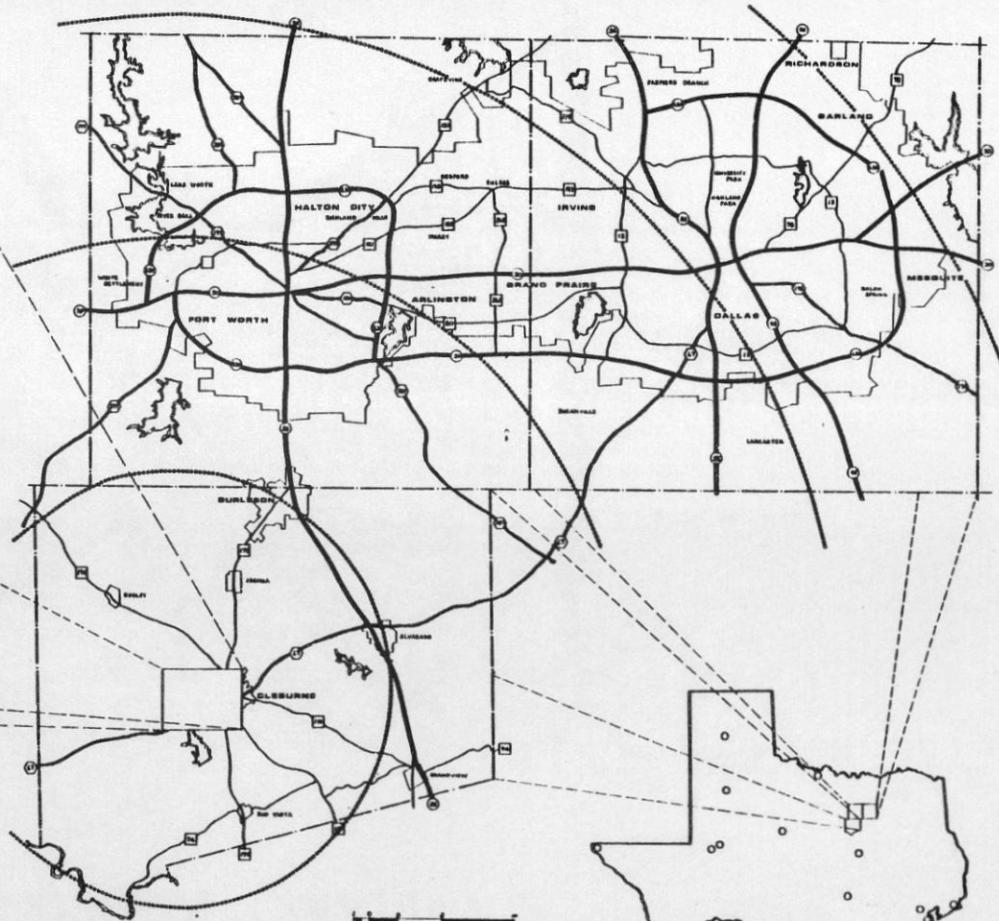
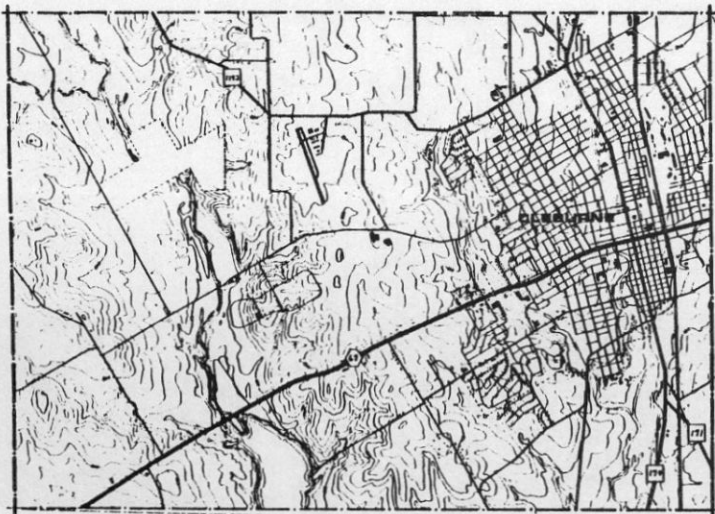

project eagle's nest

UTA - SAED • GRADUATE LANDSCAPE DESIGN
 INSTRUCTOR: J. Turner
 STUDENTS: R. Mayne • B. McDonald • R. Odlozil • M. Ostdick • M. Parkey

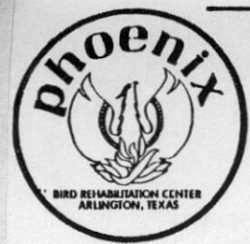

CHURCH IS VISUAL LANDMARK

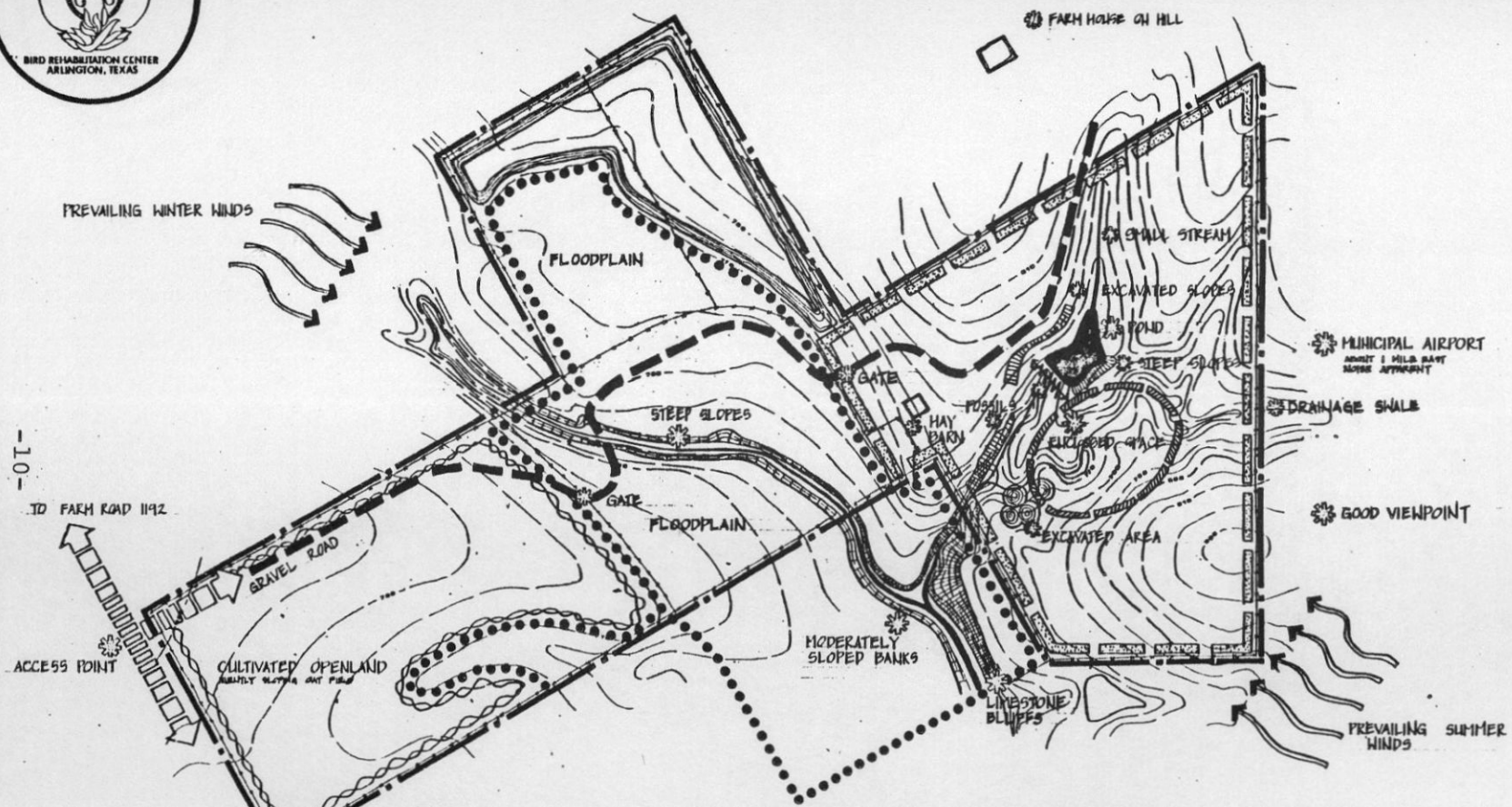

existing conditions

project eagle's nest

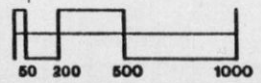

UTA - SAED • GRADUATE LANDSCAPE DESIGN
 INSTRUCTOR • J. Turner
 Fall Semester 1982
 STUDENTS • R. Mayne • B. McDonald • R. Odiozll • M. Oaldick • M. Parkey



-11-

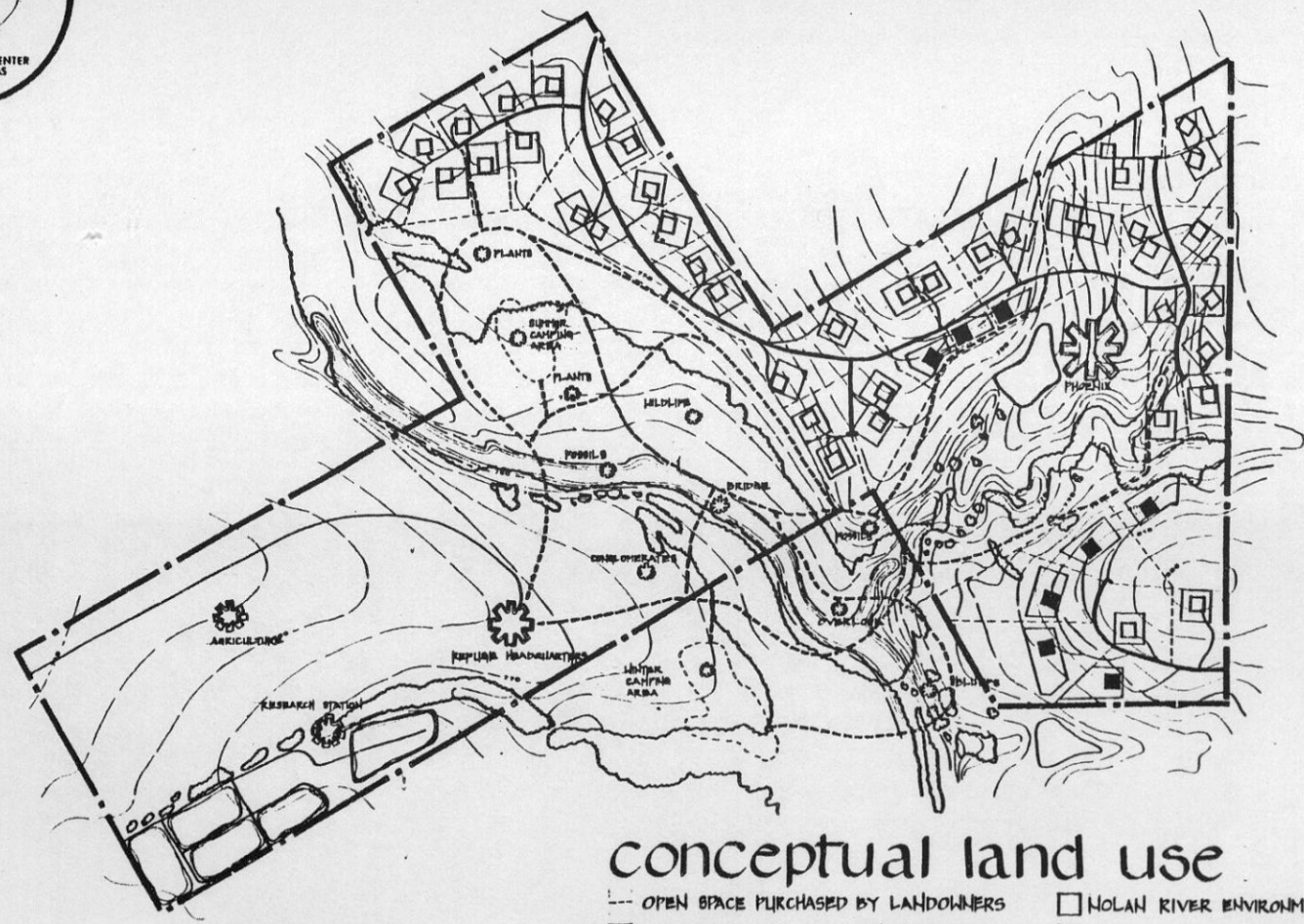

conceptual land use

- OPEN SPACE PURCHASED BY LANDOWNERS
- BUILDABLE LAND ON OWNER'S PROPERTY
- ABOVE GRADE HOUSES
- EARTH-SHELTER HOUSES
- TREE CANOPY
- NOLAN RIVER ENVIRONMENTAL REFUGE
- LANDSCAPE RESEARCH STATION
- TRAIL SYSTEM
- LANDSCAPE IMPROVEMENTS
- SIGHT LINES

project eagle's nest

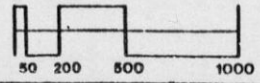

UTA - SAED • GRADUATE LANDSCAPE DESIGN
 INSTRUCTOR: J. Turner
 Fall Semester 1982
 STUDENTS: R. Mayo • B. McDonald • R. Odlozil • M. Ostidick • M. Parkey



- BUILDINGS**
- 1 HEADQUARTERS
 - 2 MEDICAL FACILITIES
 - 3 CARETAKERS RESIDENCE
 - 4 GUEST HOUSE
 - 5 MAINTENANCE/SHOP
 - 6 GARAGE
- BIRD ENCLOSURES**
- 7 EAGLE FLIGHT CAGES
 - 8 EAGLE BREEDING
 - 9 HAWK BREEDING
 - 10 OWL BREEDING
 - 11 HAWK FLIGHT CAGES
 - 12 SMALL OWL FLIGHT CAGES
 - 13 LARGE OWL FLIGHT CAGES
 - 14 WALK-THRU SONGBIRD CAGE
- VEHICULAR CIRCULATION**
- 15 ENTRY GATE/SIGNAGE
 - 16 BUS DROP-OFF
 - 17 AUTO DROP-OFF/CROSSWALK
 - 18 BUS PARKING
 - 19 TURF BLOCK AUTO PARKING
 - 20 DELIVERY SERVICE
 - 21 SERVICE CART DRIVE
- PEDESTRIAN CIRCULATION**
- 22 SEATING AREAS
 - 23 WOOD BRIDGES
 - 24 PEDESTRIAN PATH
- SITE FEATURES**
- 25 POND
 - 26 ISLAND
 - 27 KNOLL
 - 28 DAM
- FENCING**
- 29 PERIMETER 4' WIRE MESH
 - 30 POND 5' WIRE MESH
 - 31 SECURITY 6' WOOD & WIRE MESH
 - 32 SCREEN 6' SLIP



phoenix site plan

project eagle's nest

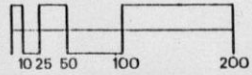

UTA - SAED • GRADUATE LANDSCAPE DESIGN
 INSTRUCTOR: J. Turner Fall Semester 1982
 T. Bodell • R. Mayne • B. McDonald • R. Odlozil • M. Ostidick • M. Parkey

DESIGN CRITERIA

Programmatic Requirements

Technical and functional requirements of the new Phoenix Bird Rehabilitation Center have been determined through a series of interviews with the directors of Phoenix. They are as follows:

1. Visitor Center - to serve as headquarters for the Phoenix staff and as an education facility for visitors.
 - a) reception hall - with stone fireplace, group seating;
 - b) information counter - to dispense literature, sell Phoenix memberships;
 - c) office space - one private office, adjacent general office space for three workers;
 - d) lecture hall - with raised stage for lectures, movie and slide presentations, audio-visual booth with remote control, slide storage;
 - e) nature display area - flexible exhibit space with movable display cases;
 - f) library - avian library with peripheral shelves, must accommodate other functions such as conferences.
 - g) sales area - securable display counters and shelves for sale of books, calendars, posters, etc.;
 - h) rest rooms.

2. Medical Facility - to provide medical care and food preparation for birds.
 - a) surgery - with operating tables, high intensity lighting, scrubbing sinks, refrigerated and non-refrigerated medicine storage, supply storage;
 - b) recovery room - with holding cages for post-op birds, countertop space for incubators;
 - c) field research laboratory - to include countertop work space, work table and benches, utility sink, freezer storage, cabinet storage, and file storage;
 - d) office - with record storage;
 - e) food preparation room - with countertop preparation area, sinks, storage space (including seed bins), prey breeding area, three chest freezers, two refrigerators, incinerator, delivery access.

3. Dormitory Housing - for visiting lecturers, youth groups, and ornithology students:
 - a) 10-12 dormitory rooms, double occupancy;
 - b) 2 rooms, single occupancy;
 - c) dining hall and kitchen - to accomodate 50-80 diners, with delivery access;
 - d) showers, men's and women's;
 - e) rest rooms, men's and women's;

- f) lounge area with kitchenette;
- g) laundry room.

4. Caretaker's Residence:

- a) 3 bedrooms;
- b) 2½ baths;
- c) 2 car garage.

5. Maintenance Building:

- a) workshop;
- b) storage room;
- c) service vehicle storage (1 pickup truck, 1 tractor, 1 golf cart);
- d) adjacent outdoor work area;
- e) outdoor storage.

6. Flight Cages - for housing birds prior to release, must provide sheltered area, perching trees, rodent-proofing, electricity and water:

- a) 3 owl cages;
- b) 5 hawk cages;
- c) 1 songbird and non-releasable bird cage.

7. Captive Breeding Cages - must provide shelter, perches, rodent-proofing, electricity and water, concealed feeding, and observation port:

- a) 2 for large raptors;

- b) 3 for medium raptors;
- c) 3 for small raptors.

8. Project Eagle's Nest - captive breeding and flight cages for bald eagle breeding program:

- a) 2 flight cages - open to public view, requirements as above;
- b) 2 breeding cages - secluded, requirements as above.

9. Pond Area - for breeding and rehabilitation of waterfowl and shorebirds:

- a) shallow area with island retreat from predators;
- b) deep area for divers;
- c) vegetation to shelter from elements;
- d) restraining fencing;
- e) observation area.

10. Public Trail System:

- a) parking to lodge;
- b) lodge to flight cages;
- c) lodge to pond and other natural features.

11. Service Trail System:

- a) residence to lodge;
- b) residence to maintenance building;
- c) residence to cages.

12. Entry - single access drive
 - a) securable gate
 - b) logo signage

13. Parking - porous paving surface, 100 yards minimum from bird cages, screened from view
 - a) 30 cars permanent parking
 - b) 20 cars reserve parking
 - c) 2 bus spaces

14. Outer Perimeter - buffer zone (100' minimum width)
 - a) security fencing
 - b) landscape planting for privacy, wind protection
 - c) earth berms for same

15. Site Utilities
 - a) well water
 - b) electricity (possible on-site generation)
 - c) telephone
 - d) septic tanks

Square Footage Summary

	<u>sq. ft.</u>
1. Visitor Center	
a) reception foyer with coat storage	350
b) information counter	60
c) office space	
private	120
general	300
d) lecture hall	
150 occ. min. @ 18 s.f./occ.	2700
audio-visual	100
e) display area	800
f) library	600
g) sales area	400
h) rest rooms	240
	<hr/>
sub-total	5670
20% for mech. & circ.	1130
	<hr/>
TOTAL	6800
2. Medical Facility	
a) surgery	400
b) recovery room	480

	<u>sq. ft.</u>
c) research laboratory	400
d) office	120
e) food preparation	150
cold storage	50
prey breeding	100
	<hr/>
sub-total	1700
20% for mech. & circ.	340
	<hr/>
TOTAL	2040

3. Dormitory Housing

a) double rooms	
10 @ 110 s.f./rm.	1100
b) single rooms	
2 @ 90 s.f./rm.	180
c) dining hall	
50 occ. min. @ 20 s.f./occ.	1000
kitchen	200
d) showers	
2 @ 95 s.f.	190
e) rest rooms	
2 @ 140 s.f.	280
f) lounge	350

	<u>sq. ft.</u>
g) laundry	100
	<hr/>
sub-total	3400
20% for mech. & circ.	680
	<hr/>
TOTAL	4080
4. Caretaker's Residence	1800
5. Maintenance Building	1800
	<hr/>
TOTAL CONDITIONED SPACE REQUIRED:	16500 s.f.
6. Flight Cages	
a) owls (3 @ 800 s.f.)	2400
b) hawks (5 @ 1000 s.f.)	5000
c) songbirds and non-releasables	3750
	<hr/>
TOTAL	9150
7. Captive Breeding Cages	
a) 2 @ 1000 s.f.	2000
b) 3 @ 750 s.f.	2250
c) 3 @ 500 s.f.	1500
	<hr/>
TOTAL	5750

sq.ft.

8. Project Eagle's Nest

a) flight cages

2 @ 7500 s.f.

15000

b) breeding cages

2 @ 2600 s.f.

5200

TOTAL

20200

9. Parking

a) 30 cars permanent

10500

b) 20 cars temporary

7000

c) 2 buses

500

TOTAL

18000

Functional Relationships

The major functions of the new Phoenix Center can be divided into three general categories: 1) public functions; 2) semi-private functions; and 3) private or service functions. This categorization is as shown below:

<u>Public</u>	<u>Semi-Private</u>	<u>Private/Service</u>
visitor center	dormitory housing	caretaker's residence
dining hall	flight cages	medical facility
songbird cage	Project Eagle's Nest	breeding cages
		maintenance building

The separation of public and private/service functions is a primary concern in the design of this facility. Several of the functions (most notably the breeding cages and medical facility) require a great degree of privacy and must be separated and/or screened from noise-generating functions, such as the maintenance facility and the lecture hall.

There are exceptions, however, to the general categorization of program elements. The caretaker's residence, for instance, is a private element, yet it must relate functionally to nearly every other element of the program. This is necessary as the caretaker oversees the operation of the entire facility. This suggests that special consideration must be given to the caretaker's residence, in order to provide the necessary degree of privacy, as well as functional convenience.

Another special case is Project Eagle's Nest, the breeding and flight cages for bald eagles. The eagle breeding program is perhaps Phoenix's most publicized function. For this reason, the eagle cages should be given a prominent location. However, while the eagle flight cages may be allowed to have limited public access, the breeding cages require absolute privacy. Since it is desirable to keep the two elements of Project Eagle's Nest in one location, this presents a problem requiring special attention.

The hawk and owl flight cages are to be used for the keeping of birds after their recovery from injuries or "graduation" from the breeding program, and prior to their eventual release in the wild. These cages may double as breeding cages when necessary. They should be allowed limited access to the public, thus their categorization as a semi-private function.

Concern for the separation of public and private/service functions applies not only at the large-scale site planning level, but also at a smaller scale when considering the integral functions of the visitor center. The offices require a large degree of privacy, and should be separated from public activity areas. The lecture hall and library must obviously be isolated for noise control purposes - the former being a noise-generating space; the latter, a quiet study space.

Other functions may deserve a more central location; for instance, the information counter (as a control function), the sales area, the exhibit space and, of course, the rest rooms.

Psychological Considerations

Daylight

Diffuse natural light is a desirable psychological factor and especially so in a facility of this nature. Those functions for which it is essential include: 1) the nature exhibit space; 2) the library; 3) the post-op recovery room; and 4) all office spaces. With the exception of the surgery room, where only artificial light is desired, natural light should be provided for all other spaces, insofar as it is practical. Control over the amount of natural light received should also be provided. Control of natural light is especially important for the lecture hall, to facilitate daytime slide shows or movie presentations.

Privacy

All office spaces, the library, the residential functions, the medical facilities, and the breeding cages should be provided with adequate privacy--both visually and acoustically. The flight cages for the birds, of course, require some degree of privacy, but should provide for limited public viewing. Most other spaces do not require this consideration, as they are public activity functions.

Thermal Comfort

The psychological well-being of the user is dependent in large part on his thermal comfort. Standard mechanical systems will be augmented to a significant extent by simple passive

measures, such as the provision of thermal mass of radiant heat (which contributes more to thermal comfort than convected heat), and adequate ventilation in the summer. This subject is described in more detail in the discussion of energy issues later in the text.

Noise

Certain functions must be isolated acoustically, either because they are noise generating functions (such as the maintenance building) or because their function demands a quiet environment (the medical facility and the offices). Isolation can be achieved by physical separation of functions or by acoustical insulation where separation is not practical.

Color

Consistent with the stated intent of a facility which responds to and respects its environment, the exterior colors should be earth-tones which complement the natural surroundings. Interior colors may be lighter earthtones in order to maximize the effectiveness of available natural light. Brighter primary colors might be used as the exception in order to highlight certain events, such as the display areas or the signage along the circulation paths.

Legal and Contextual Constraints

Under the terms of the proposed agreement with the landowners, the Phoenix Corporation will lease its property for a period of five years, at the end of which time the land will be donated to the Phoenix Corporation, provided that development has proceeded according to the proposed plan. The agreement will be concluded during the summer of 1983, establishing the exact boundaries of the property (presently between twenty to twenty-five acres in area) and the location of the future access road.

As the site is outside of the Cleburne city limits, there are no binding development codes or zoning ordinances which would apply to the facility. Neither the county nor the state have regulations which pertain to the project, with the exception of state food service guidelines and waste treatment regulations. For the purposes of this project, the Uniform Building Code will be used as a general guide.

As mentioned in the Site Description, the surrounding context will consist of single-family housing on the high ground on three sides of the project. Since the Phoenix facilities will consist of several smaller buildings, most of which will be comparable in size to single-family dwellings, there should be no conflict in scale between the two. In addition, the new Phoenix Center will be surrounded by a buffer zone for security and privacy reasons, which will further enhance the image of Phoenix as a separate entity.

An ecological preserve will be located on the west side of the Center, which may or may not be under the control of Phoenix as part of the lease agreement. In any case, it will be left in its natural state, and the Phoenix Center will, in a sense, be an extension of the preserve, or the mediator between the natural environment and the public.

Symbolic Parameters

The new Phoenix Center should promote a certain character or image which is consistent with its function. It must convey an image of concern and respect for nature, as it is a caretaker of natural assets, and it must promote an inviting image as part of its public function.

The client has also set certain criteria regarding the image of the Visitor Center. These include the use of natural wood as a structural and finish material, large windows, high ceilings, and exposed beams, all of which contribute to an open and inviting recreational lodge character. The form and exterior materials of the other buildings should be compatible with these characteristic, in order to promote a consistent character throughout the complex.

A major proponent to a natural image will be the sensitive siting of the buildings and the preservation or enhancement of existing natural features. The end result should be a facility which has a real sense of belonging to its site - a "sense of place."

Economic Parameters

An overall budget for the new Phoenix Center has not been established, as funding will be dependent on the generosity of future donors. The design of the new facility must take these budget constraints into account. It will be necessary to employ simple construction methods and to utilize common, locally available materials. On-site materials, such as native stone, may be employed where practical. It is important, however, not to sacrifice quality or durability in the interest of expense. For this reason, it will be necessary to provide a phased plan for construction of the new facility, extending development over a period of several years.

Energy Issues

Conservation of Energy is an important issue for the Phoenix Center, partly because of their role as a conservator of natural resources, and partly because of operating budget constraints.

Steps toward energy conservation can begin as early as the preliminary design phase by the zoning of functions which have similar patterns of use (and thus similar internal heat gain characteristics) in the same part of the building. High heat-generating spaces (such as mechanical spaces and kitchens) in particular, should be isolated and properly ventilated.

Adequate ventilation of the buildings will contribute significantly to reducing cooling costs during parts of the year. Operable windows and proper orientation will provide for cross-ventilation.

Various other passive measures will be employed in order to reduce energy costs. Such measures as proper sizing of overhangs to block the summer sun and admit winter sunlight, thermal mass for heat storage, earth-sheltering where practical, adequate insulation, and maximum use of natural light to reduce artificial lighting demand.

Another energy issue which should be explored is the possibility of on-site generation of electricity. Given the remoteness of the site, it may be a matter of years before

development approaches close enough so that electricity can be obtained at the site at a reasonable cost. In the interim, electric power may be generated on-site (most likely by wind power) in an amount sufficient to provide for Phoenix's needs during the early stages of its development.

CASE STUDIES

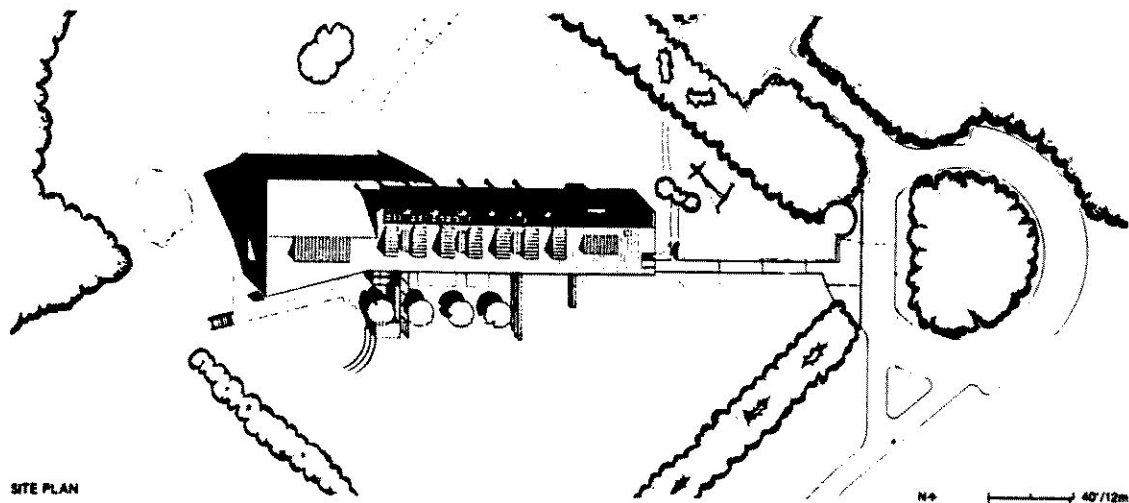

MILFORD RESERVATION ENVIRONMENTAL CENTER
Milford, PA
Kelbaugh & Lee, Architects, 1980

Milford Center is a 17,000 s.f. live-in environmental education center for urban youths. It is located on a three-acre site within a 1600-acre wilderness reservation in the Pocono Mountains of Pennsylvania. The major program elements of the facility consist of dormitory housing for 117 youths, classrooms and workshops, a dining hall, and offices for the staff.



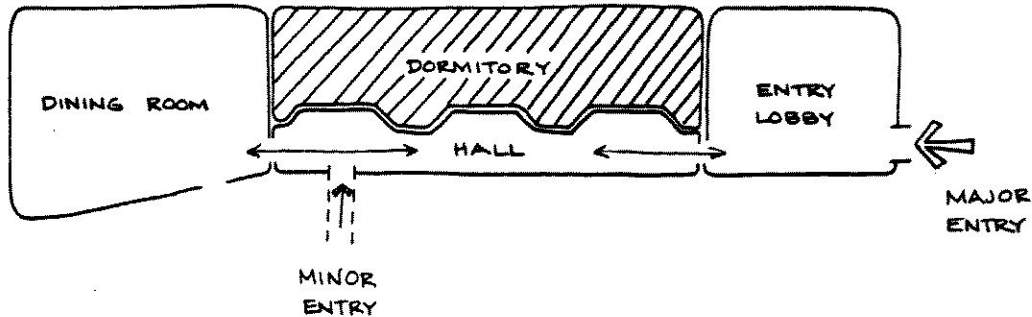

The arrangement of the functions is in a linear form, extending along the East-to-West axis for maximum southern exposure. This linear form is broken down into three basic components: 1) an entry hall at the East end; 2) a dormitory/classroom zone in the center; and 3) the dining hall at the Western end. The major social spaces (entry hall and dining hall) are intentionally located at opposite ends of the building. The resulting back and forth traffic through the wide hall makes for a more dynamic circulation space, which also can become an important social gathering place in itself. The separate functional zones are articulated on the outside by changes in the roofline and fenestration, which also helps to modulate the horizontal scale of the building.

There are three floor levels in the building, all of which have a Southern exposure. Earth is bermed on the East side to the second floor level, and to the third floor level on the North

side. The lowest level contains the dining hall, classrooms, and workshops. The entry lobby and lower dormitory rooms are located on the second level, and the third level contains the upper dormitory rooms and staff offices.

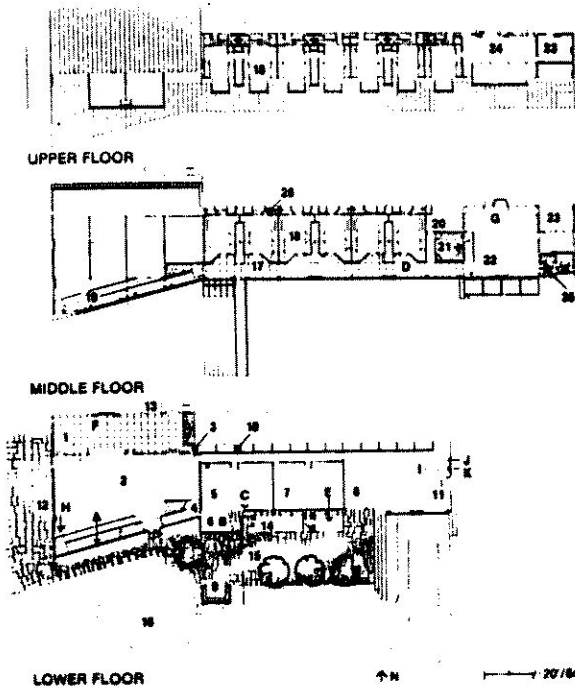

Legend

- | | |
|-----------------------------------|--------------------------------|
| 1 Kitchen | 19 Ramp |
| 2 Dining hall | 20 Infirmary |
| 3 Janitor's closet | 21 Handicapped/public restroom |
| 4 Storage | 22 Lobby |
| 5 Classroom | 23 Office |
| 6 Greenhouse | 24 Balcony |
| 7 Workshop | 25 Vestibule |
| 8 Utility room | 26 Typical toilet room |
| 9 Pavilion | A Trombe wall |
| 10 Typical composting toilet tank | B Greenhouse with mass wall |
| 11 Clivus multrum toilet tank | C Water drum cabinet |
| 12 Porch | D Direct gain space |
| 13 Loading dock and service road | E Reflector/insulating shutter |
| 14 Vegetable garden | F Thermal drape/curtain |
| 15 Courtyard | G Circulating air fireplace |
| 16 Amphitheater | H Wood stove |
| 17 Gallery | I Oil/wood furnace |
| 18 Typical dormitory room | J DHW heater |
| | K DHW storage tank |

Energy efficiency was a primary concern in the design of the facility. Solar exposure was a major determinant of the building's form, and solar gain has been utilized by a variety of passive and active solar systems. Trombe walls with night insulation front both the lobby and the dining halls, and direct gain is utilized on all three levels of the central zone. In addition, a solar domestic hot water heater is concealed beneath a skylight on the Northern edge of the roof. The day-to-day operation of these systems is entrusted to the youths, and thus becomes an important part of their environmental education experience.

The exterior of the building is finished with cedar siding which, along with the sloping rooflines and large windows, contributes to a vernacular mountain-lodge character. The design of the facility, as a whole, is very sensible and unobtrusive, yet also somewhat sophisticated. As a case study, it conforms very well to the intentions of the design project in terms of image, budget, and the ideals of the Phoenix Center.

FLAT ROCK BROOK CENTER FOR ENVIRONMENTAL STUDIES
Englewood, NJ
Ballou-Levy-Fellgraff, Architects, 1980

The purpose of the Flat Rock Brook Center is to provide environmental education facilities for an urbanized public. It is located at the entrance to a 75-acre wooded tract of land at the southern edge of New Jersey's Palisades forest. The main trail of the Center's grounds bisects the building, the structure thus becoming a special "place" along the path.

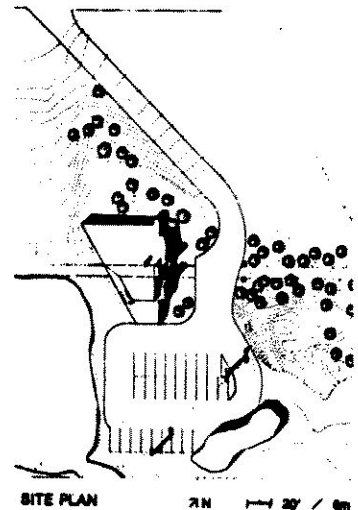

Maximum flexibility was desired in the design, in order to accommodate diverse use patterns (daily and seasonal) and group sizes. The wide central hall can be opened at both ends and along its sides, allowing internal activities to interact with the main circulation of the path.

Equally important to the designers was a desire for energy efficiency. The building applies simple, demonstrable solar concepts in such a way that the building becomes a teaching tool for energy-saving concepts, as well as natural studies.

On opposite sides of the central hall along the extensively glazed south facade are the instructional areas the meeting room and the workshop. Concrete floor slabs in

these major spaces absorb heat for reradiation. Between the meeting room and the south glazing is a greenhouse buffer zone, with heat gain storage in the form of water-filled plastic tubes. The greenhouse opens to the meeting room with sliding glass doors, and the exterior glazing is equipped with roll-down shutters to provide shade or insulation. A trellis provides shade for the south-facing workshop windows, which are also equipped with roll-down shutters.

Mounted on the south wall adjacent to the workshop are solar hot-air collectors, which are connected by ducts to a rockbed heat storage bin, or alternatively to the staff offices directly to the north.

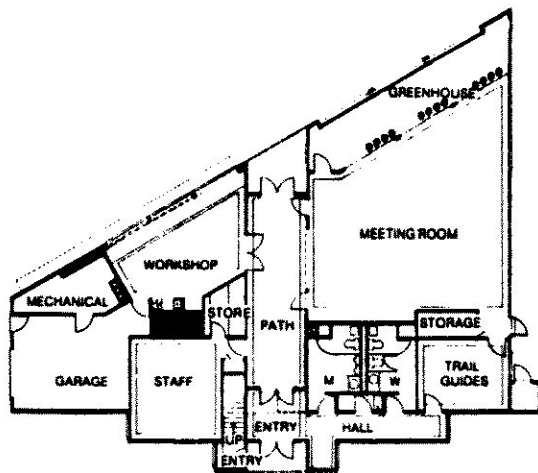

FIRST FLOOR

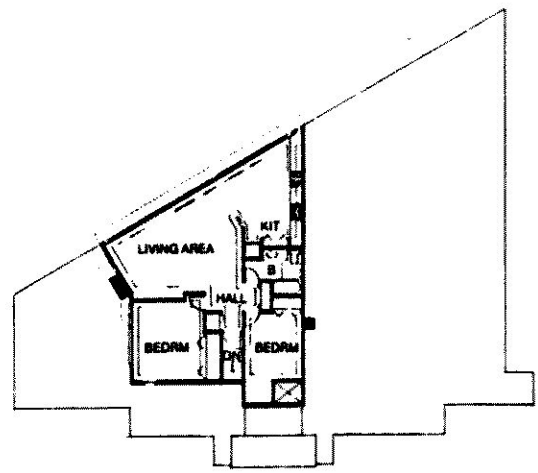

SECOND FLOOR

The Center director's apartment is located on the second floor. It also is oriented primarily southward. It receives direct gain through windows and skylights, though there is no provision of heat storage on this level. On both levels, the private or service functions are located along the north wall, forming a buffer zone from the elements and freeing the glazed southern wall for the larger activity areas, which are equipped with independent thermostatic controls.

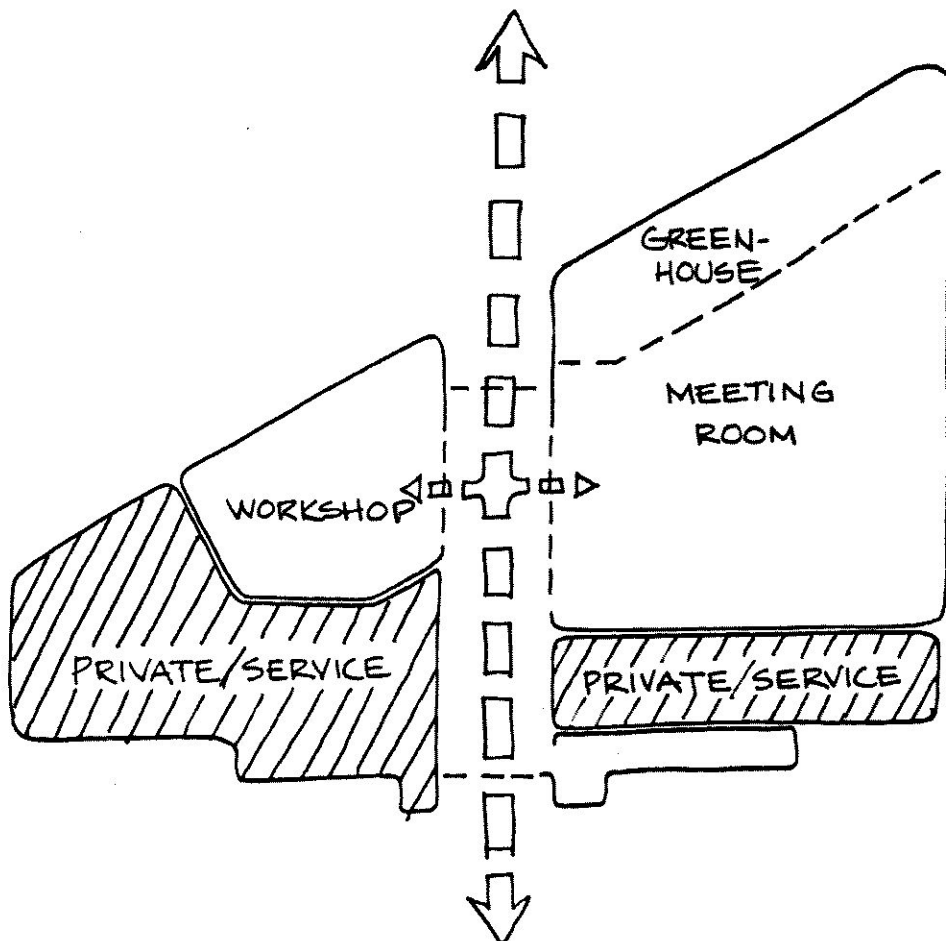

Cedar siding is used exclusively on the exterior of the building, and its gently sloping roof lines seem to conform to the topography of the site. The organization of the building, its form, and its materials, show a sensitivity to the site, and the facility's design seems to have met the given objectives in a very simple and satisfactory fashion.



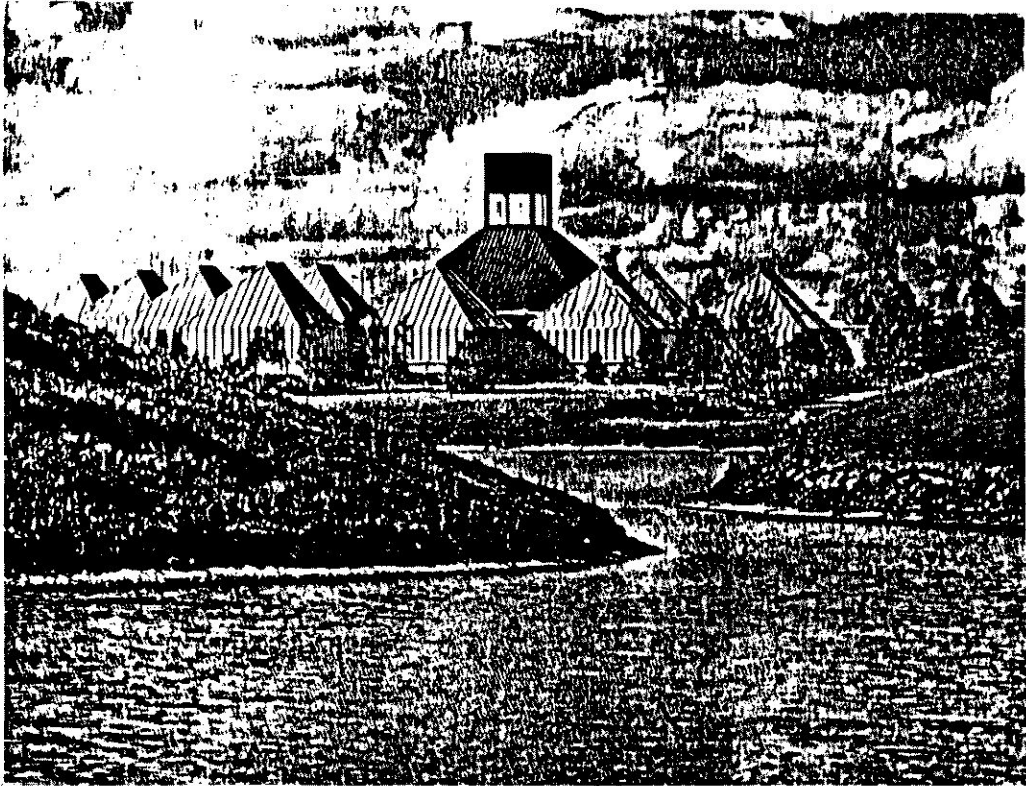

BOTANIC GARDEN ADMINISTRATION AND VISITOR CENTER
Glencoe, IL
Edward Larrabee Barnes, Architect, 1979

The Botanic Garden at Glencoe was constructed on a 320-acre tract of reclaimed marshland, about 50 miles north of Chicago. The Administration and Visitor Center is built on one of a series of garden islands. The design is very formal, axial, and symmetrical, in contrast to its free-form garden surroundings. From an external viewpoint, it seems very self-contained, a feeling which is enhanced by the 30-foot wide earth berm which raises it above its surroundings. From the inside, however, the axes extend outward to picturesque vistas.

The facilities provided in the Center include seminar rooms, classrooms, a small auditorium, a library, offices, a dining hall, an exhibition hall, greenhouses, and outdoor exhibition spaces. It is organized within a cruciform plan. The major entrance is to the north, with minor entrances to the east and west. The exhibition hall is located at the junction of the axes, with a prominent pyramidal roof. Courtyards lie to the east and west of the exhibition hall, which serve to separate the administration and education functions to the north from the greenhouse and service space to the south. The exhibition hall can be opened to the courtyards to provide a continuous outdoor space.

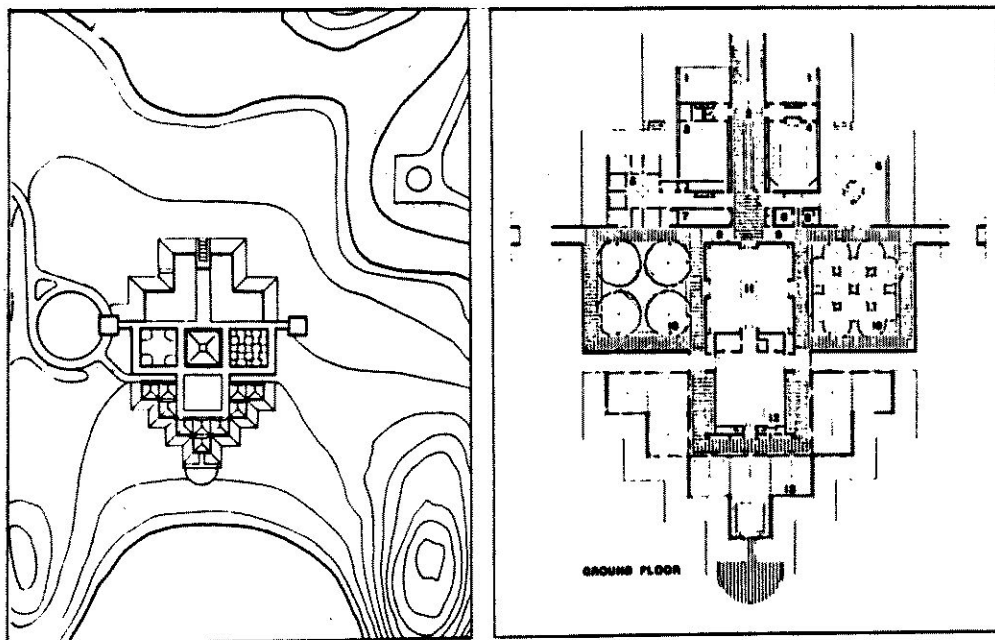

- | | | | |
|------------------------|--------------|--------------|---------------------------|
| 1 Meeting | 4 Auditorium | 7 Sales area | 10 Court |
| 2 Main gallery | 5 Offices | 8 Toilets | 11 Exhibition hall |
| 3 Library reading room | 6 Restaurant | 9 Lobby | 12 Exhibition preparation |
| | | | 13 Greenhouse |

A brick gallery forms the northern part of the main axis, which contains a reflecting pool, skylit from above. Glass doors at the end frame a view of the lagoon. This gallery space serves as a buffer zone between the library and administrative functions on the west side, and the noisier public functions on the east.

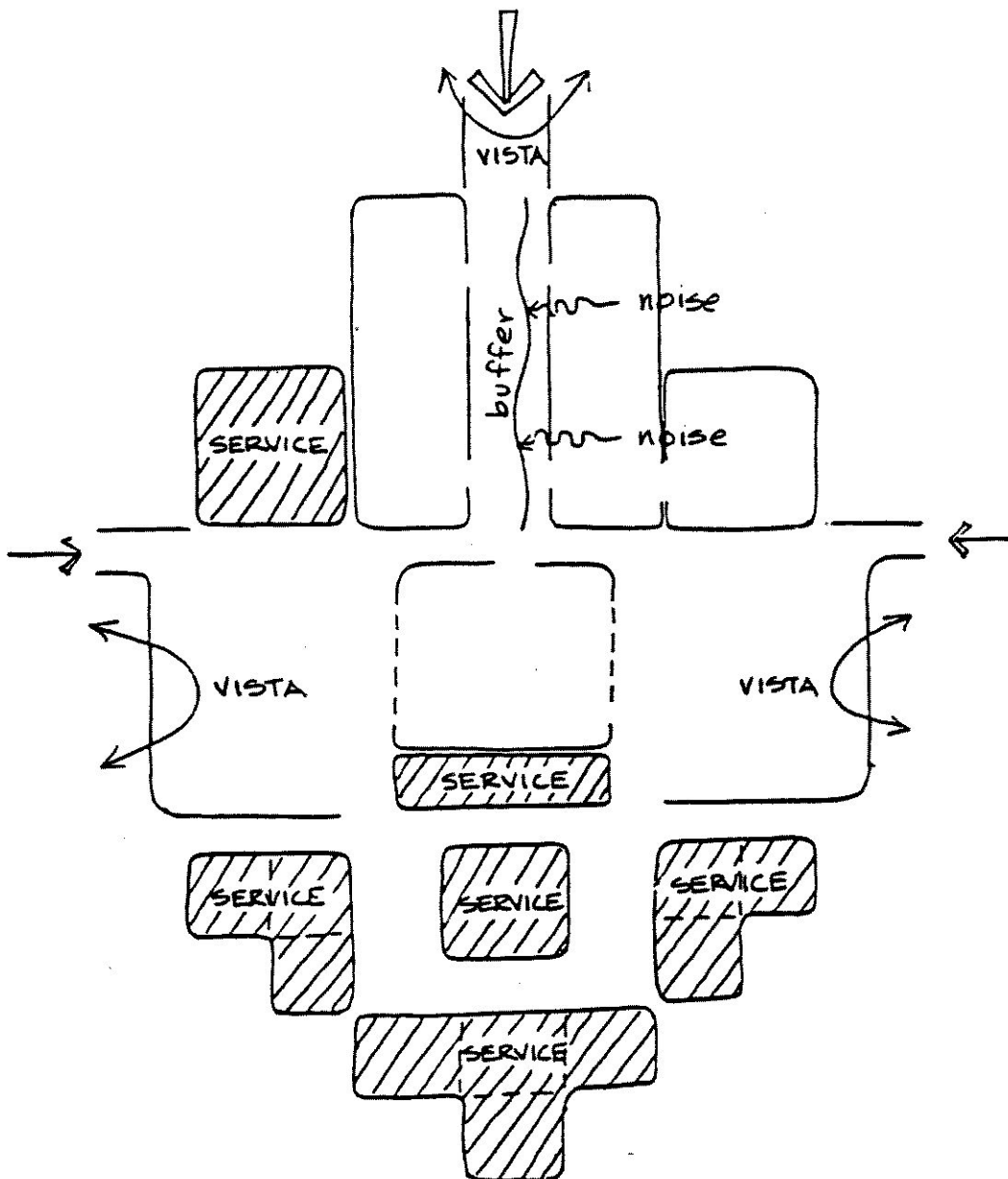

At the southern end of the Center are the greenhouse spaces. Rather than providing a single massive greenhouse, Barnes designed 10 smaller ones clustered in three groups. Besides the fact that the scale was broken down in this way, it also allowed for the provision of a variety of artificial climates. An outdoor work area is located at the center of the cluster.

Barnes employed a very limited range of materials and colors -- brick and stone for walls and paving, copper roofs, and glass. The simplicity of the materials enhances the straightforward geometry of the plan and massing, resulting in a complex which clearly stands out in a monumental way from its surroundings.

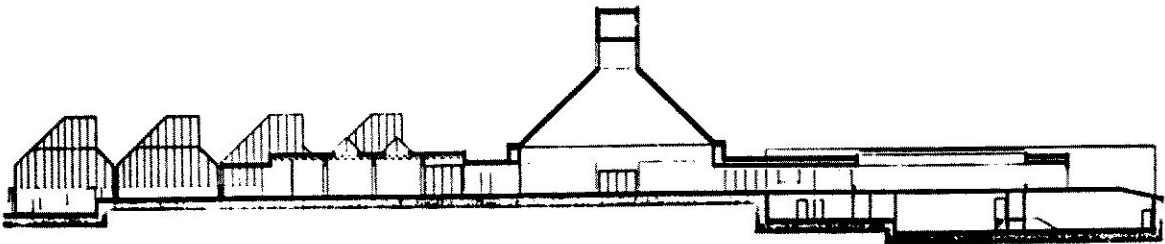

SITE ANALYSIS

SITE ANALYSIS

(refer to App. A, p. 51)

Site Character

The vegetative cover on the majority of the site is an association of native grasses, consisting primarily of switchgrass, Indiangrass, and panicum on the higher zones, with sedge occurring on the poorly drained bottom land. The native tree cover found on the site is composed of cedar elm, hackberry, juniper, and mesquite trees. Tree cover occurs in dense strands in the lower valleys, and in sparsely scattered clusters throughout most of the rest of the site.

The open upper slopes create broad viewsheds across the man-made pond and the wooded valleys. The character of these areas suggest that some may be utilized as building sites or as pedestrian circulation where dramatic views may be desired.

The wooded valleys, on the other hand, possess a strong sense of spatial enclosure due to the surrounding topography and the dense tree cover. These portions of the site may be best suited as locations for the breeding cages, as they require privacy and isolation from noisy functions.

The dominant topographic feature of the site is a prominent ridge which runs from northeast to southwest, just to the south of the pond. This ridge effectively separates the site

into two halves, with broad viewsheds to either side, and from its peak to the foot of the slope southwest of the pond. This feature should be an important consideration in site planning, both as a factor in site circulation and in the location and orientation of the program elements.

Percent Slope

The total elevational change on the site is approximately fifty feet. Slope has been divided into four percentile categories: 1) 0-4 percent (suitable for all uses); 2) 4-8 percent (marginal for roads and parking, acceptable for most other purposes); 3) 8-12 percent (unsuitable for roads or parking, acceptable for most other uses, may require special measures); and 4) 12 percent (unsuitable for most used without special measures).

Given the nature of the site, slope may be one of the most restrictive factors to be considered in site planning. It can be seen from the diagram (App. A, p. ii) that the area in which parking may occur is especially restricted, and large portions of the site are so steep as to be generally unsuitable for most other purposes.

Soils and Drainage

The Phoenix Center site contains two distinctly different soil types. Their characteristics are summarized as follows:

Purves-Brackett Association. This association is a shallow clayey and loamy upland soil. It exists as a relatively shallow surface layer, with an underlying limestone that may be found as outcroppings. Areas with this type of soil are only moderately favorable for urban land use. Deficiencies may be overcome by proper planning and management, at moderate expense.

Trinity-Pursley Association. This soil type is a deep, clayey loam, found on bottom land with shallow slopes. It is a poorly drained soil, subject to frequent flooding, with severe shrink-swell characteristics. It is unsuitable for building site development, though it has fair potential as habitat for wildlife.

Site drainage flows through two major systems, separated by the central ridge, which converge at the western end of the site. The northern drainage system originates at the outflow from the man-made pond, while the southern consists of a winding valley which originates to the east of the site. The lower portions of these drainage systems are obviously unsuitable as building sites, and where circulation paths may cross a drainage swale, uninterrupted drainage flow must be accommodated.

The Nolan River floodplain extends onto the site as far as the dam, to an elevation of 770 feet above sea level. This is an area which is unsuited for building purposes, though it may be utilized as wildlife habitat.

Climate

As is typical of the region, the climate at the site is characterized by hot, humid summers and mild winters. Summer breezes generally originate from the south to southeast, while winter winds blow from the northwest. It is desirable, therefore, for building location and orientation to minimize the exposure to cold winter winds while maximizing the flow of summer breezes. These effects may be augmented by proper landscaping.

Shade from the summer afternoon sun is also an important factor, especially considering the large amount of outdoor activity which will occur at the facility. As little tree cover exists on the site outside of the valleys (which are of limited use for building because of the steep slopes), shading devices and additional planting should be utilized to provide sun control.

These climatic factors indicate that the optimum building site may be located on the south-facing slope at the northeast end of the central ridge. The southern exposure would provide for proper sun control as well as access to cooling summer breezes. This location also provides one of the best viewpoints on the site - across the wooded valley to the south and across the pond to the west.

APPENDIX A

PRESENTATION DRAWINGS

PHOENIX BIRD REHABILITATION CENTER CLEBURNE, TEXAS

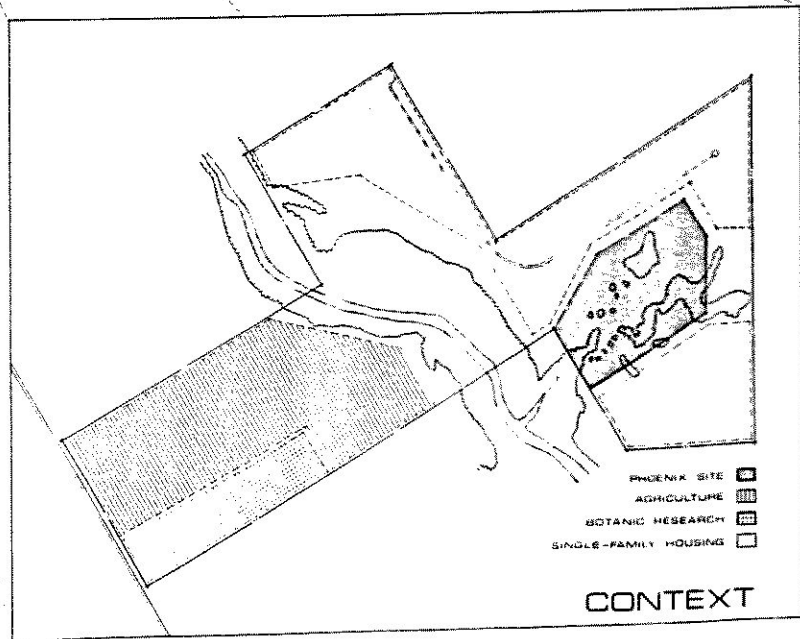
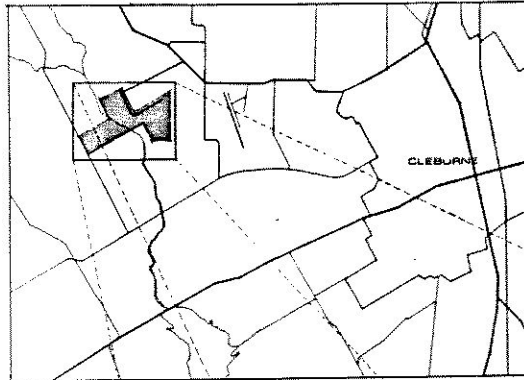
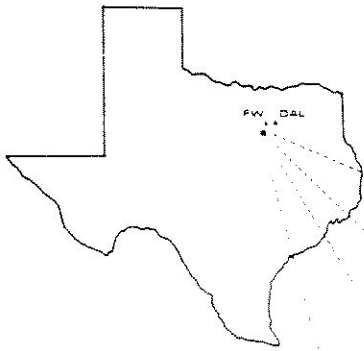

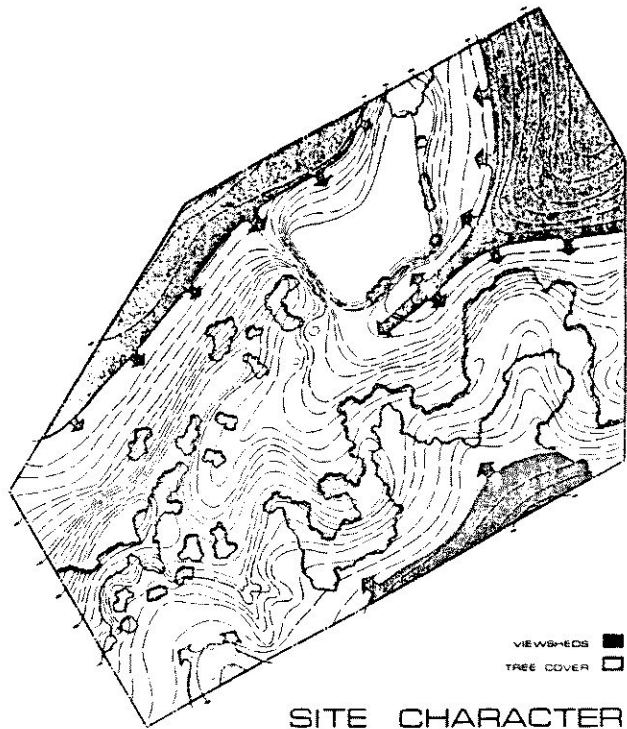

SITE CHARACTER

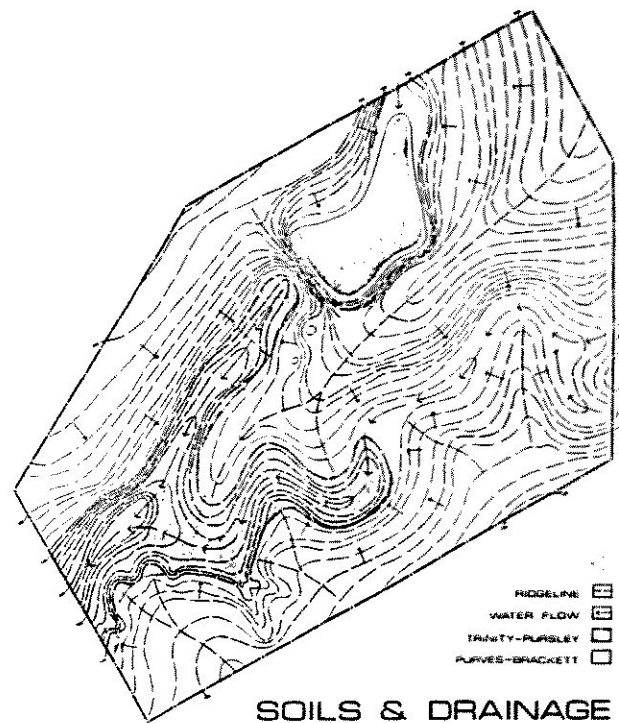

SOILS & DRAINAGE



PERCENT SLOPE

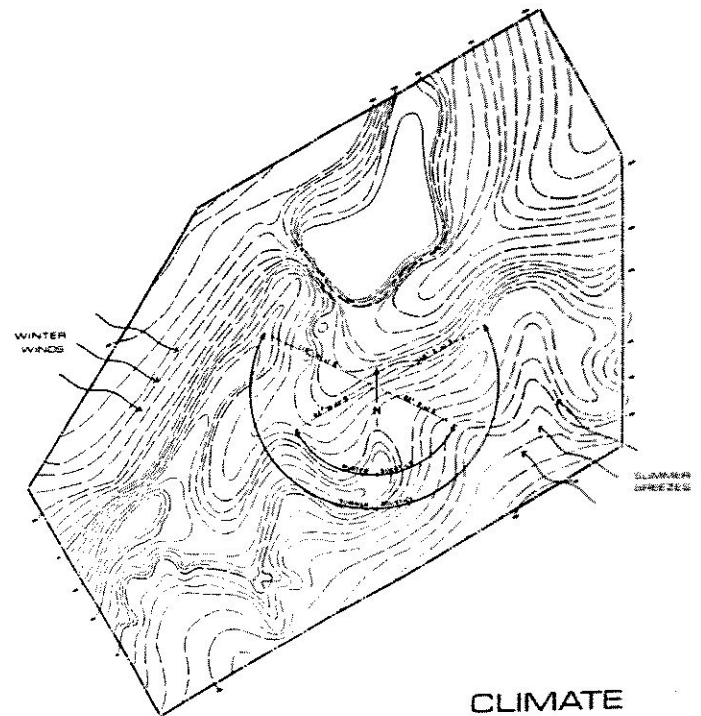

CLIMATE

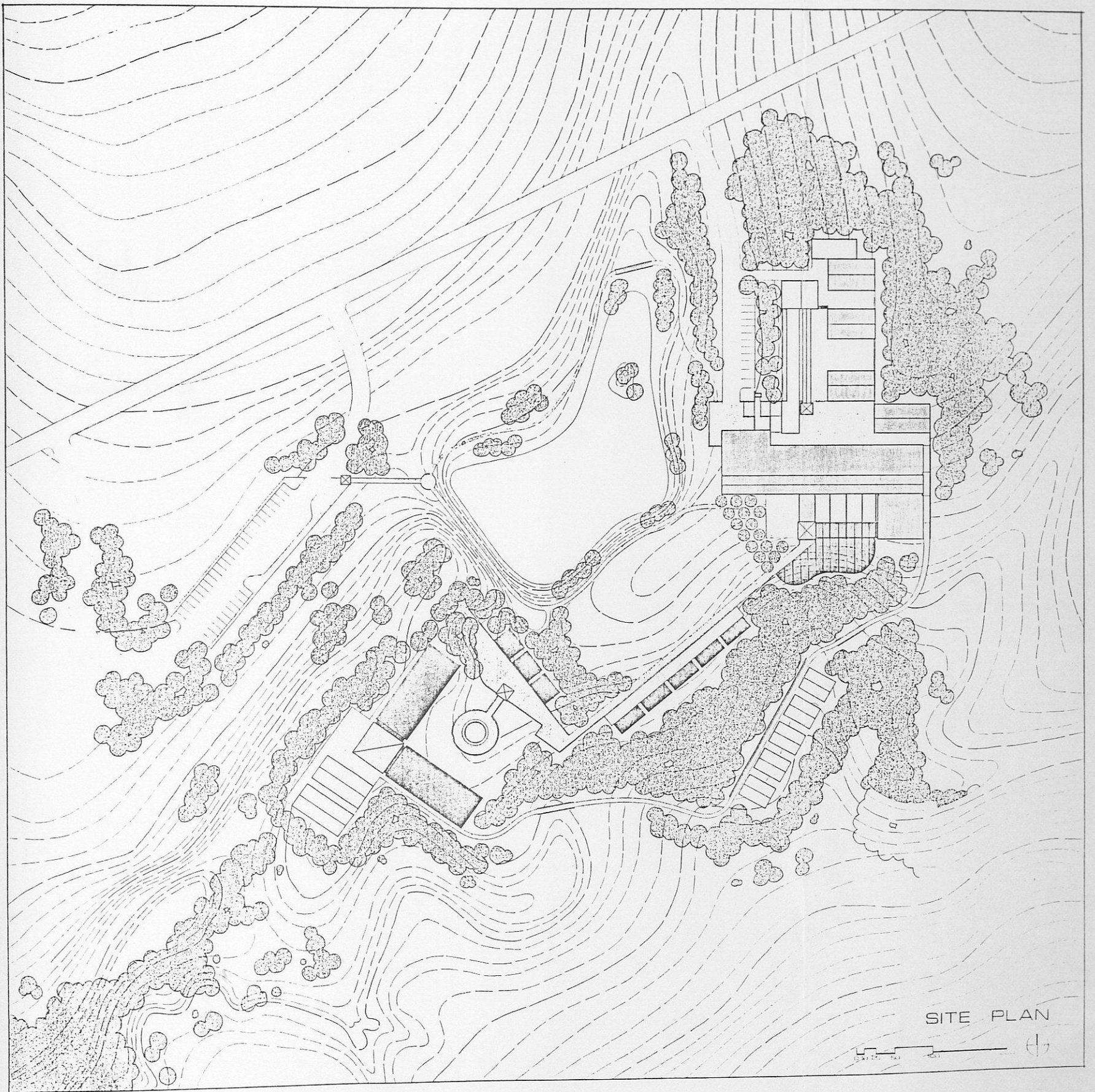

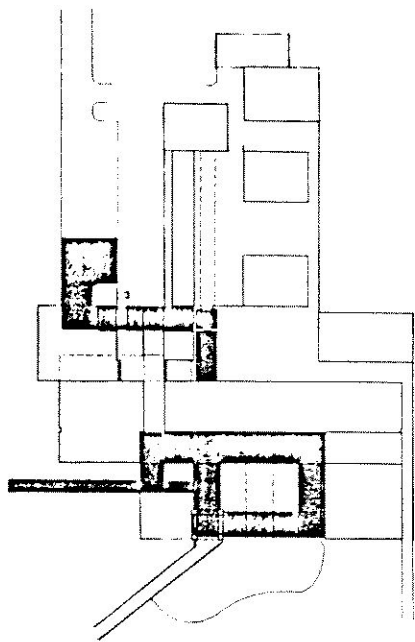

PUBLIC
CIRCULATION

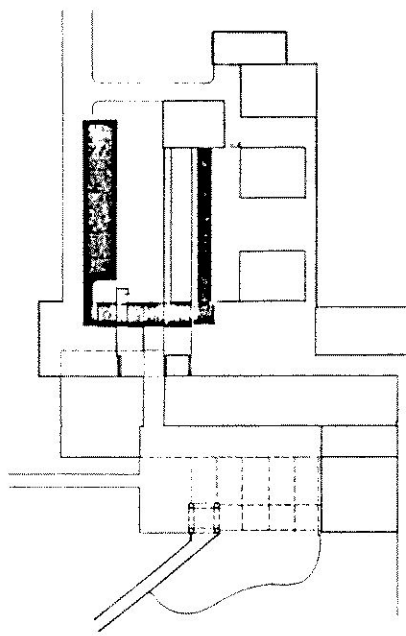

SEMI-PRIVATE
CIRCULATION

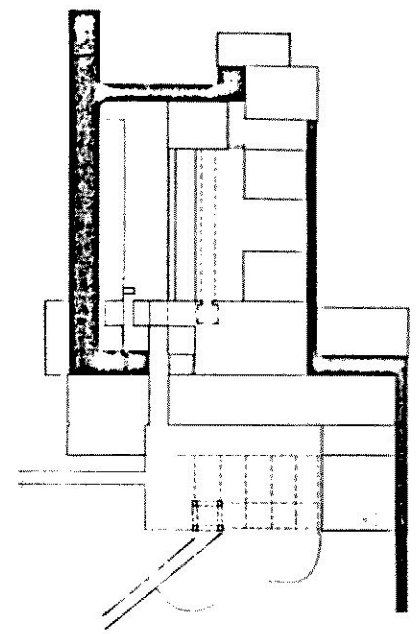

SERVICE
CIRCULATION

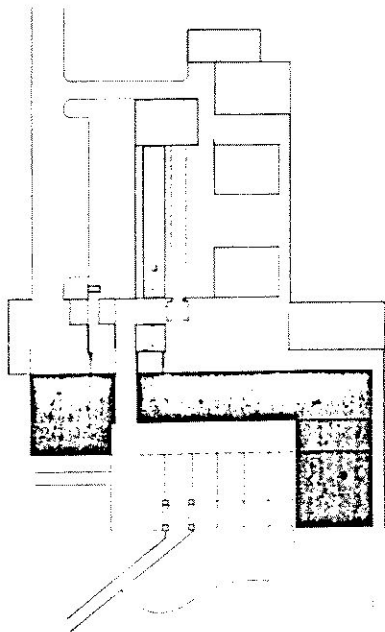

PUBLIC / PRIVATE

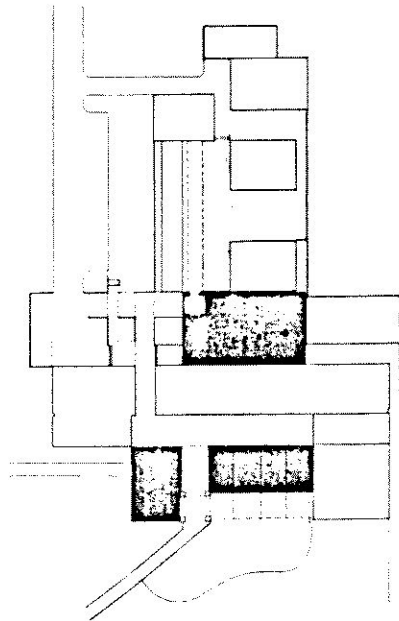

COURTYARDS

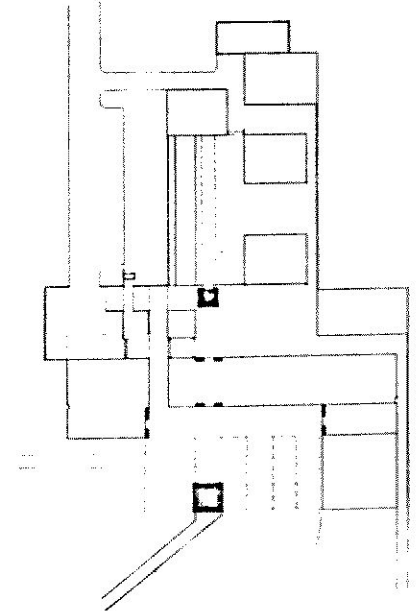

ENTRY

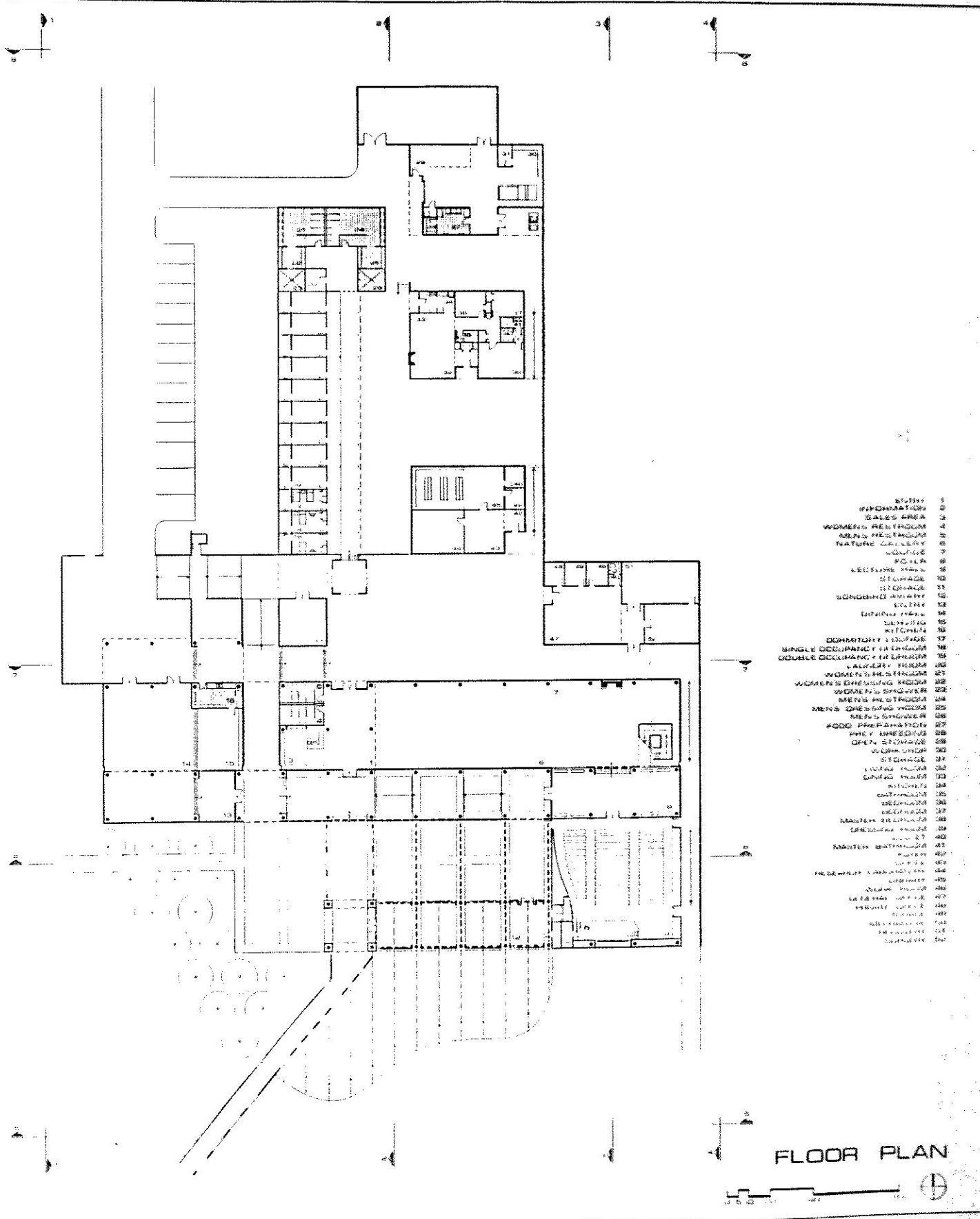

- RECEPTION 1
- INFORMATION 2
- SALES AREA 3
- WOMEN'S RESTROOMS 4
- MEN'S RESTROOMS 5
- NATURE GALLERY 6
- RECEPTION 7
- RECEPTION 8
- RECEPTION 9
- RECEPTION 10
- RECEPTION 11
- RECEPTION 12
- RECEPTION 13
- RECEPTION 14
- RECEPTION 15
- RECEPTION 16
- RECEPTION 17
- RECEPTION 18
- RECEPTION 19
- RECEPTION 20
- RECEPTION 21
- RECEPTION 22
- RECEPTION 23
- RECEPTION 24
- RECEPTION 25
- RECEPTION 26
- RECEPTION 27
- RECEPTION 28
- RECEPTION 29
- RECEPTION 30
- RECEPTION 31
- RECEPTION 32
- RECEPTION 33
- RECEPTION 34
- RECEPTION 35
- RECEPTION 36
- RECEPTION 37
- RECEPTION 38
- RECEPTION 39
- RECEPTION 40
- RECEPTION 41
- RECEPTION 42
- RECEPTION 43
- RECEPTION 44
- RECEPTION 45
- RECEPTION 46
- RECEPTION 47
- RECEPTION 48
- RECEPTION 49
- RECEPTION 50
- RECEPTION 51
- RECEPTION 52
- RECEPTION 53
- RECEPTION 54
- RECEPTION 55
- RECEPTION 56
- RECEPTION 57
- RECEPTION 58
- RECEPTION 59
- RECEPTION 60
- RECEPTION 61
- RECEPTION 62
- RECEPTION 63
- RECEPTION 64
- RECEPTION 65
- RECEPTION 66
- RECEPTION 67
- RECEPTION 68
- RECEPTION 69
- RECEPTION 70
- RECEPTION 71
- RECEPTION 72
- RECEPTION 73
- RECEPTION 74
- RECEPTION 75
- RECEPTION 76
- RECEPTION 77
- RECEPTION 78
- RECEPTION 79
- RECEPTION 80
- RECEPTION 81
- RECEPTION 82
- RECEPTION 83
- RECEPTION 84
- RECEPTION 85
- RECEPTION 86
- RECEPTION 87
- RECEPTION 88
- RECEPTION 89
- RECEPTION 90
- RECEPTION 91
- RECEPTION 92
- RECEPTION 93
- RECEPTION 94
- RECEPTION 95
- RECEPTION 96
- RECEPTION 97
- RECEPTION 98
- RECEPTION 99
- RECEPTION 100

FLOOR PLAN

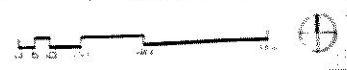

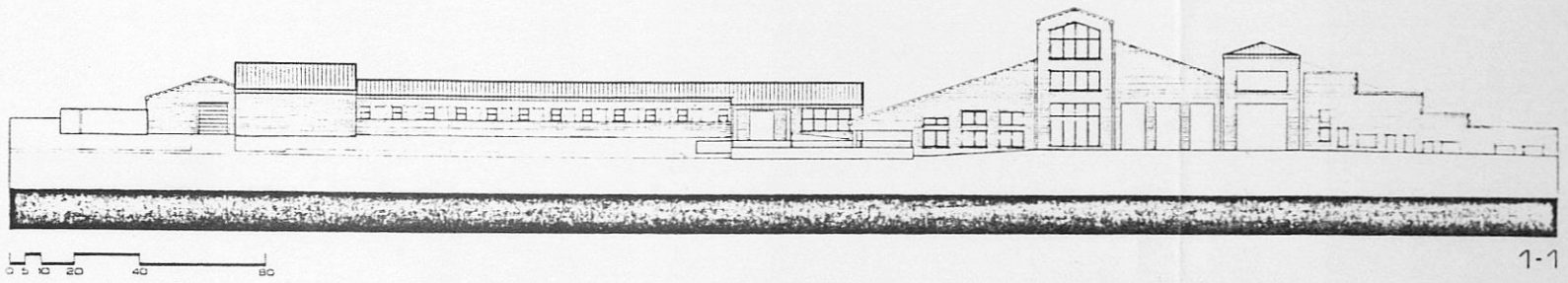

1-1

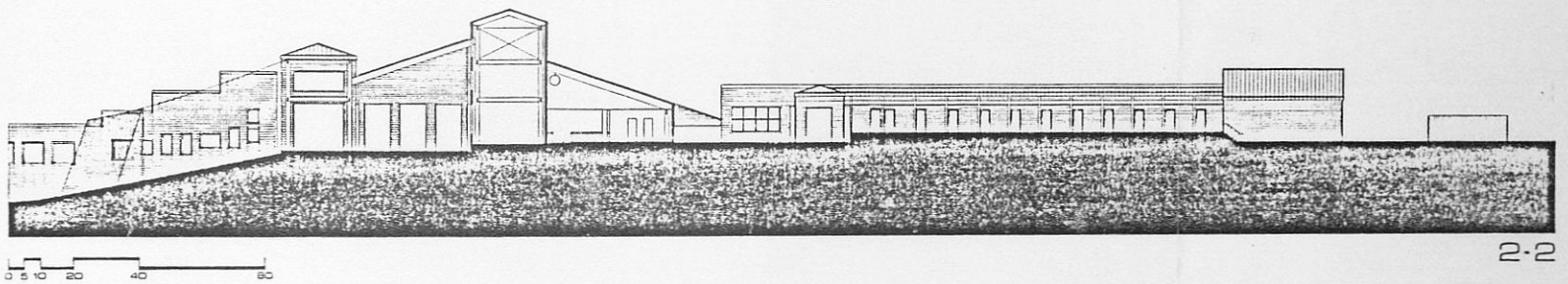

2-2

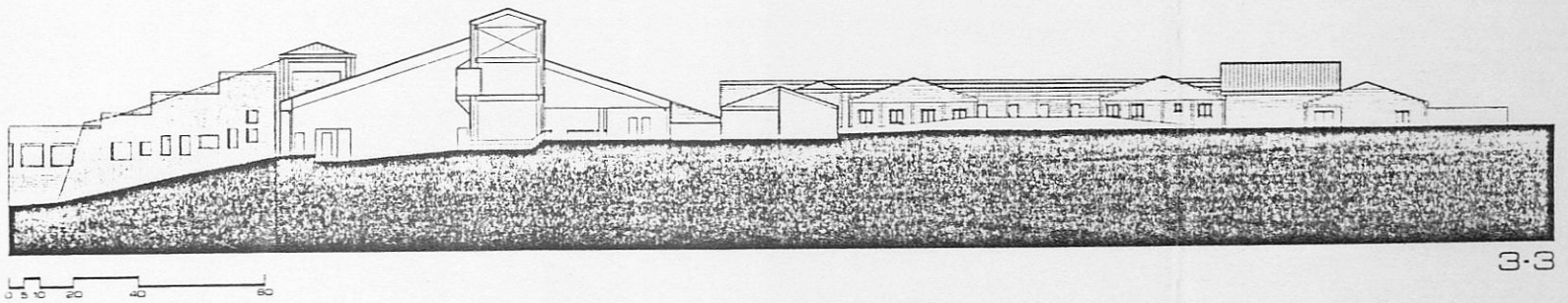

3-3

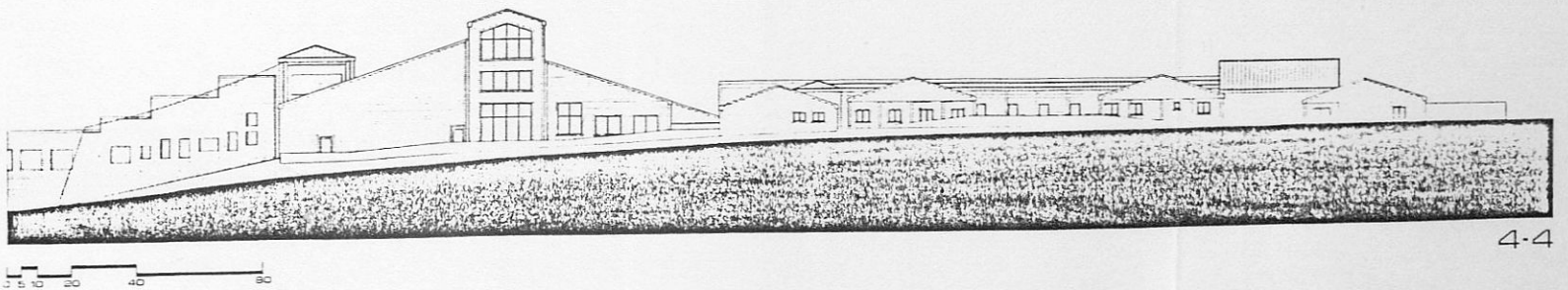

4-4

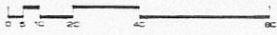
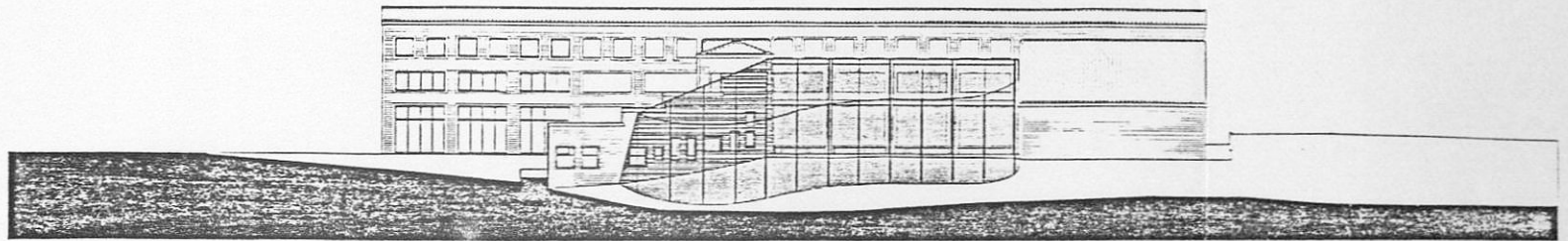

5-5

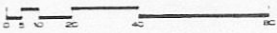
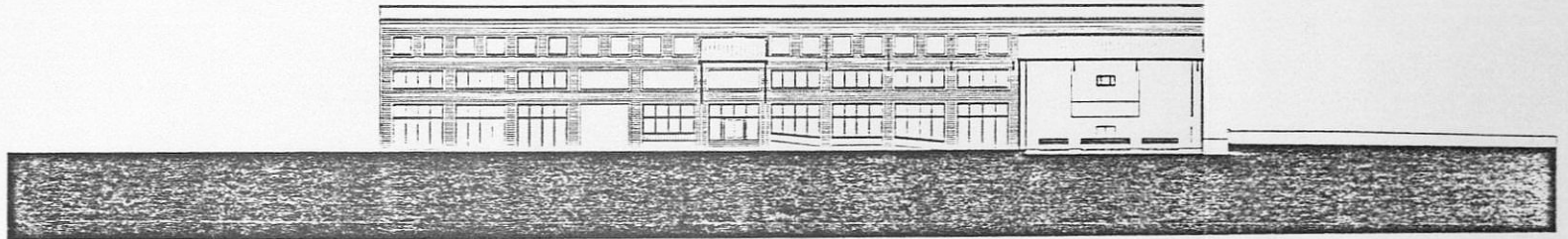

6-6

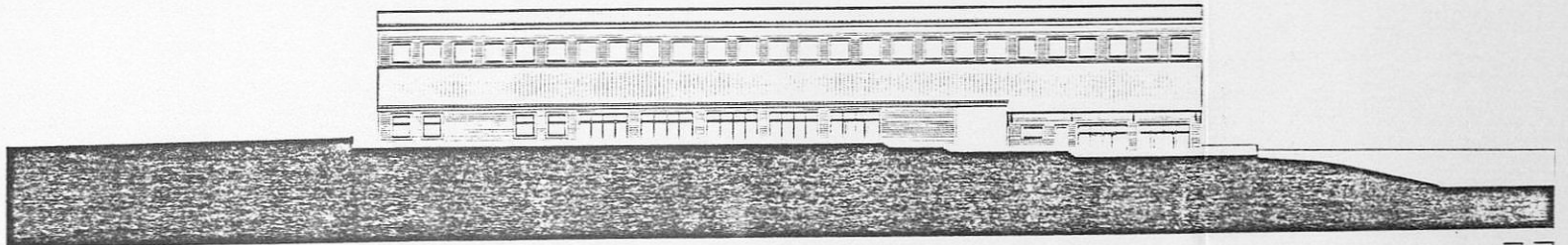

7-7

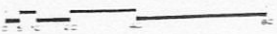
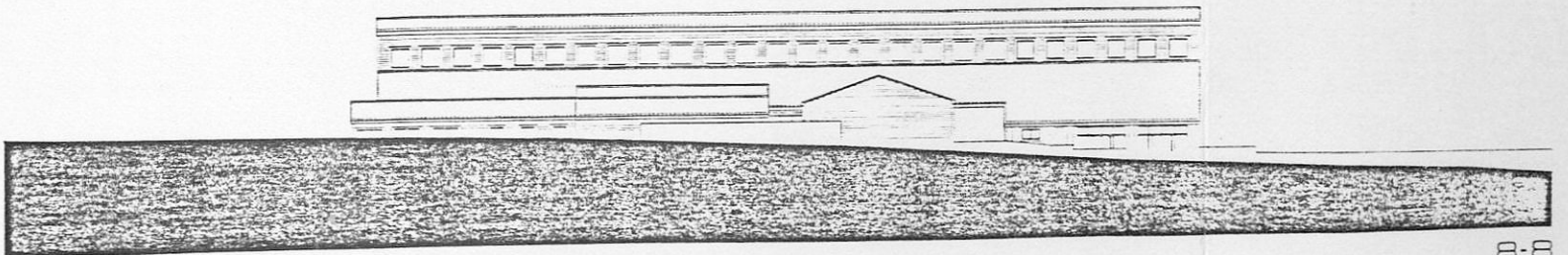

8-8

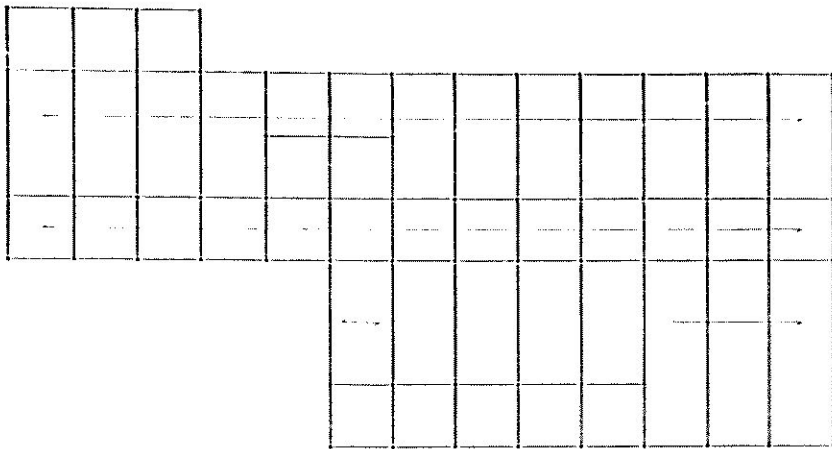

STRUCTURE

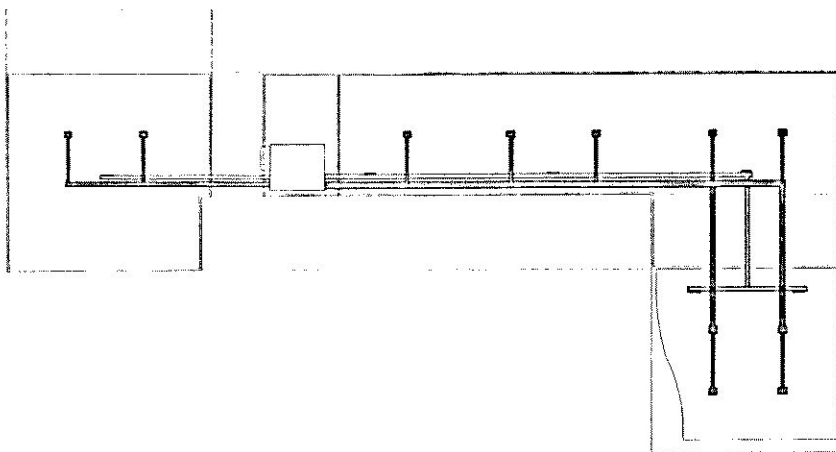

MECHANICAL

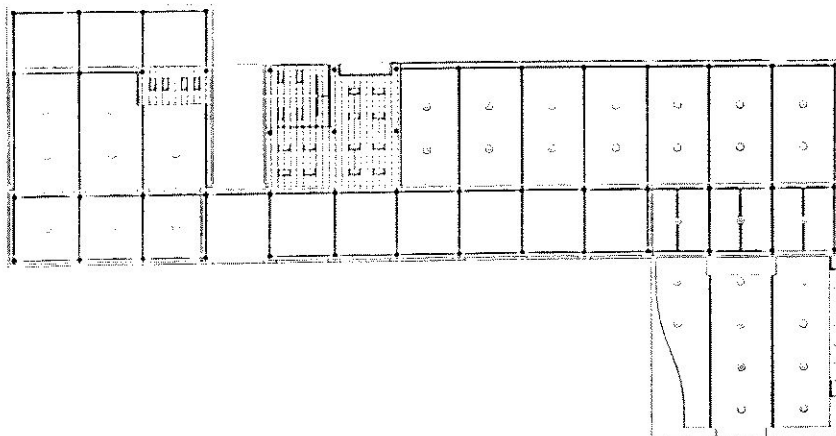

REFLECTED CEILING PLAN

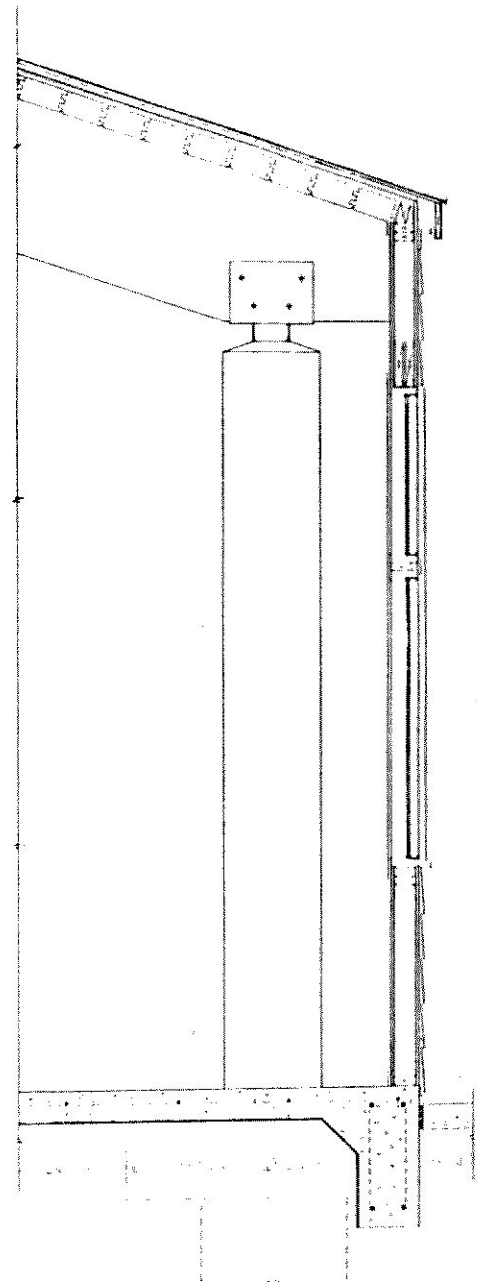

WALL SECTION

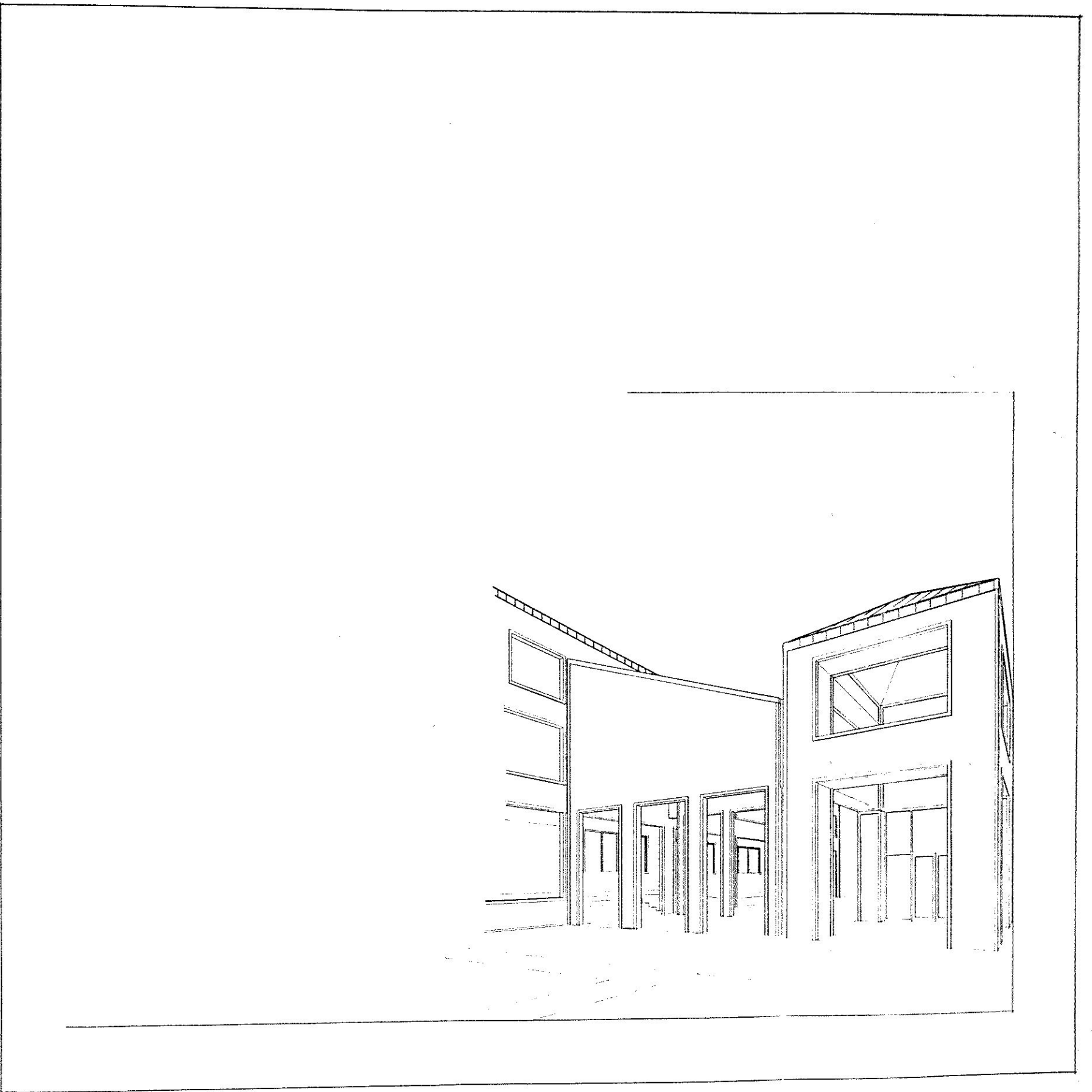

APPENDIX B

COMPREHENSIVE EXAMINATION

Structural Calculations
and
Professional Examination

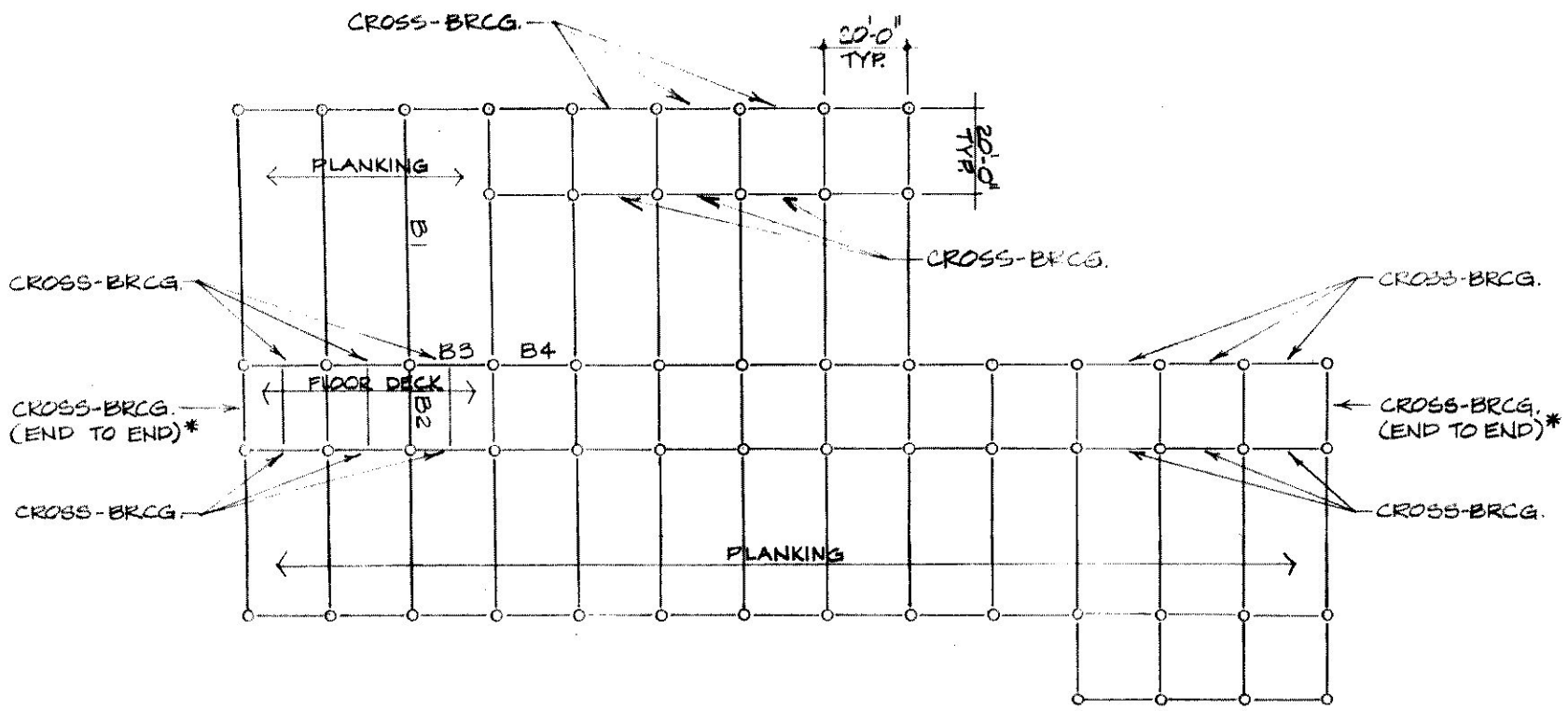

STRUCTURAL FRAMING PLAN

SCALE: 1" = 40'-0"

* DOUBLE DEPTH OF BRACING @ 1ST & 3RD BAYS FROM EACH END

MATERIALS

- Roofing - galvanized metal, standing seam.
- Roof Deck - glue-laminated Douglas Fir planking, decorative grade, random length continuous application.
- Floor Deck - solid heavy timber decking, Douglas Fir select, controlled random layup.
- Beams - glue-laminated Douglas Fir, Architectural grade.
- Columns - round concrete w/spiral reinforcement.
- Wind Bracing - steel tension rods w/turnbuckles.
- Walls - 2" x 4" nominal studs, vertical cedar siding exterior, 5/8" gyp. bd. interior.
- Foundation - slab on grade, w/ integral spread footings, grade beams.

LOAD CALCULATIONS

ROOF LOAD:

LIVE LOAD (TABLE 23-C, UBC)

lbs/s.f.

16*

22 GA. GALVANIZED METAL

1

ROOFING FELT, 3-PLY

1

1" RIGID INSULATION

2

5" NOM. GLULAM DECKING

11

BEAMS

3

MECHANICAL

2

TOTAL ROOF LOAD = 36 psf

FLOOR LOAD:

LIVE LOAD (TABLE 23-A, UBC: OFFICE USE)

lbs/s.f.

50

2" NOM. SOLID WOOD DECKING

5

BEAMS

5

TOTAL FLOOR LOAD = 60 psf

* Live load reduction for beam design - use 14 lbs/s.f.

DESIGN ROOF DECK :

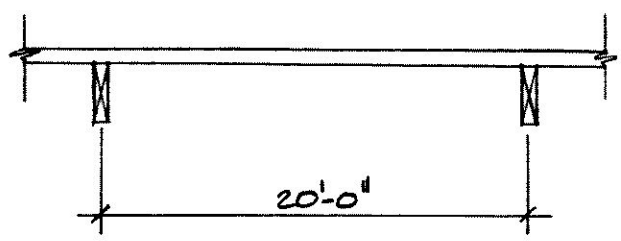

$TL = 31 \text{ psf} *$
 $\text{span} = 20'-0''$
 $\Delta_{\text{allow}} = L/240$

specify : Douglas Fir ($f_b = 2640 \text{ psi}$) glulam
 random length continuous application

select 5" nominal thickness ($3\frac{5}{8}$ actual) **

allowable uniformly distributed total roof load
 = 41 psf

$31 \text{ psf} \overset{\text{OK}}{<} 41 \text{ psf}$

* total roof load minus beams and mechanical

** from Potlatch Lock-Deck Technical Data

DESIGN FLOOR DECKING:

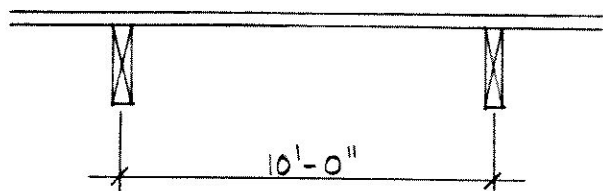

$$TL = 60 \text{ psf}$$

$$\text{span} = 10' - 0''$$

$$\Delta_{\text{allow}} = L/240$$

specify: Douglas Fir Select solid timber decking,
controlled random layup

select 3" x 6" nom. decking (2 1/2" x 5 1/4" actual)*

allowable uniformly distributed total load

$$= 94 \text{ psf}$$

$$60 \text{ psf} <^{\text{OK}} 94 \text{ psf}$$

* from AITC Glulam Systems, 1982.

DESIGN B1:

span = 60'-0"
 spacing = 20'-0"
 DL = 20 psf
 TL = 34 psf.

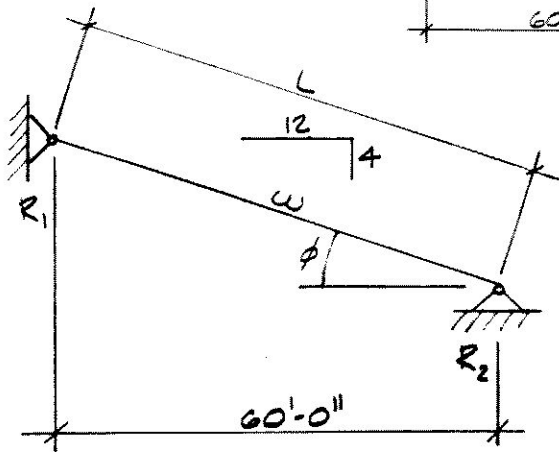
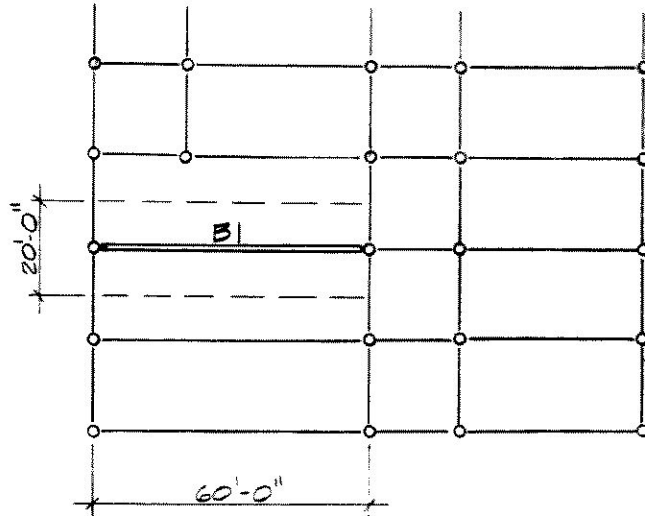

$$4/12 = \tan \phi$$

$$\phi = 18.4^\circ$$

$$60/L = \cos 18.4^\circ$$

$$L = 63.2'$$

Wind: per Table 23-H, UBC -
 roof slopes < 9:12 $C_q = 0.7$ outward
 As wind pressure acts as uplift, it is not
 considered in beam loading.

1. Bending

$$W = WL = 34 \text{ psf} (20') (63.2') = 43 \text{ K}$$

$$W_{\perp} = W \sin 71.6^\circ = 43 \text{ K} \sin 71.6^\circ = \underline{41 \text{ K}}$$

$$R_1 = R_2 = \underline{20.5 \text{ K}} \quad w_{\perp} = \frac{20.5 \text{ K}}{30 \text{ ft}} = \underline{0.69 \text{ K/ft}}$$

B1 cont'd:

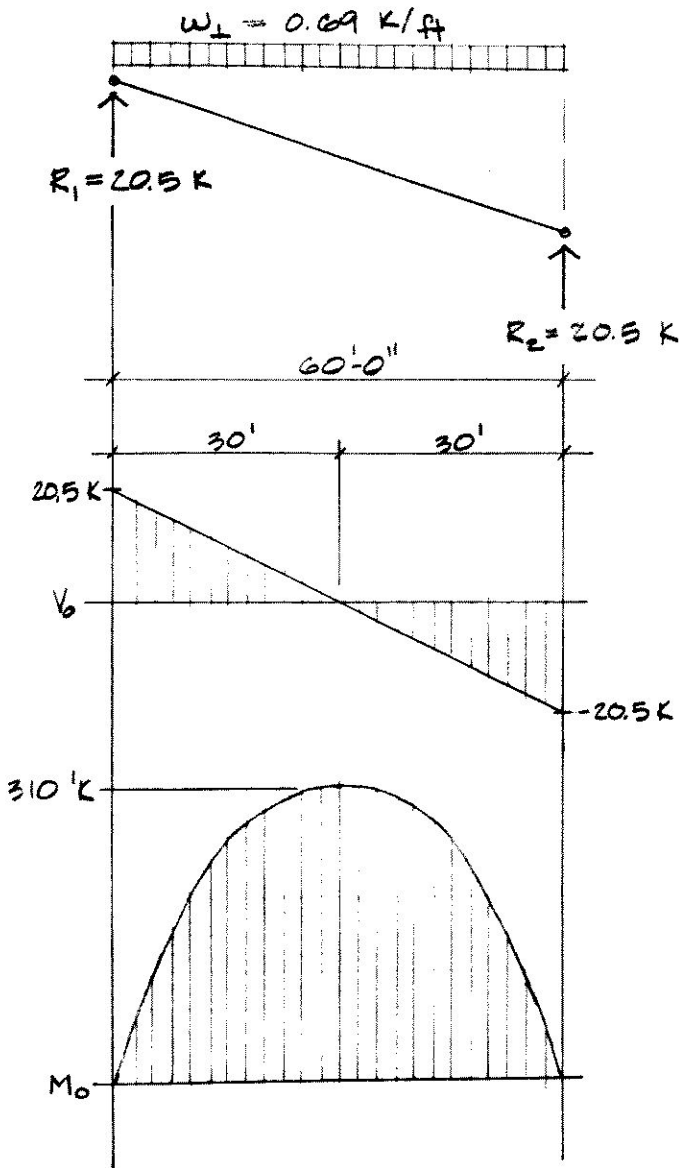

$$M = \frac{0.69 \text{ k/ft} (60 \text{ ft})^2}{8}$$

$$= \underline{310' \text{ k}}$$

using Douglas Fir
 $F_b = 2400 \text{ psi}$

assume $C_F = 0.90$

$$C_F F_b = \frac{M c}{I} = \frac{M}{S}$$

$$S = \frac{M}{C_F F_b} = \frac{310' \text{ k} (12 \text{ in/ft})}{(0.90)(2.4 \text{ k/in}^2)}$$

$$= \underline{1722 \text{ in}^3}$$

select $6\frac{3}{4}'' \times 27 - 1\frac{1}{2}''$

laminations*

$$S = 1,845 \text{ in}^3$$

$$d = 40.5 \text{ in}$$

$$A = 273 \text{ in}^2$$

$$I = 37,400 \text{ in}^4$$

$$C_F = 0.91$$

2. Shear

$$F_v = 165 \text{ psi (Douglas Fir)}$$

$$f_v = 1.5 \frac{V}{A} = 1.5 \left(\frac{20,500 \text{ lbs}}{273 \text{ in}^2} \right) = \underline{113 \text{ psi}} < 165 \text{ psi} \quad \text{OK}$$

* p. 11, AITC Glulam Systems, 1982.

B1 cont'd:

3. Deflection

$$\Delta_{\text{allow}} = \frac{L}{240} = \frac{60 \text{ ft}(12 \text{ in/ft})}{240} = 3 \text{ in}$$

$$E = 1.6 \times 10^6 \text{ psi} \quad (\text{Douglas Fir})$$

$$I_{\text{beam}} = 37,400 \text{ in}^4$$

$$\Delta = \frac{5WL^4}{384EI} = \frac{5(690 \text{ lb/ft})(1 \text{ ft}/12 \text{ in})[(60 \text{ ft})(12 \text{ in/ft})]^4}{384(1.6 \times 10^6 \text{ lbs/in}^2)(37,400 \text{ in}^4)}$$
$$= 3.36 \text{ in} > 3 \text{ in} \quad \text{reject}$$

$$I_{\text{req'd}} = \frac{5WL^4}{384E\Delta_{\text{allow}}} = \frac{5(690 \text{ lb/ft})(1 \text{ ft}/12 \text{ in})[(60 \text{ ft})(12 \text{ in/ft})]^4}{384(1.6 \times 10^6 \text{ lb/in}^2)(3 \text{ in})}$$
$$= \underline{41,900 \text{ in}^4}$$

select 8 $\frac{3}{4}$ " x 26 - 1 $\frac{1}{2}$ " laminations

$$I = 43,250 \text{ in}^4 \quad A = 340 \text{ in}^2$$

$$d = 39 \text{ in.}$$

determine camber: $w_{DL} = 20 \text{ lb/ft}^2(20 \text{ ft}) = 400 \text{ lb/ft}$

$$\Delta_{DL} = \frac{5WL^4}{384EI} = \frac{5(400 \text{ lb/ft})(1 \text{ ft}/12 \text{ in})[(60 \text{ ft})(12 \text{ in/ft})]^4}{384(1.6 \times 10^6 \text{ lb/in}^2)(4.33 \times 10^4 \text{ in}^4)}$$
$$= 1.68 \text{ in}$$

$$\text{camber} = 1.5 \Delta_{DL}^* = 1.5(1.68 \text{ in}) = 2.52 \text{ in.}$$

specify camber of 2 $\frac{1}{2}$ in over span

* p. 10, AITC Glulam Systems, 1982.

DESIGN B2:

span = 20'-0"

spacing = 10'-0"

TL = 60 psf

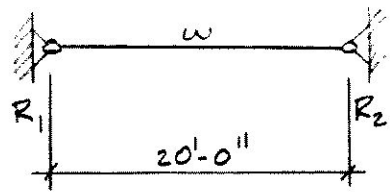
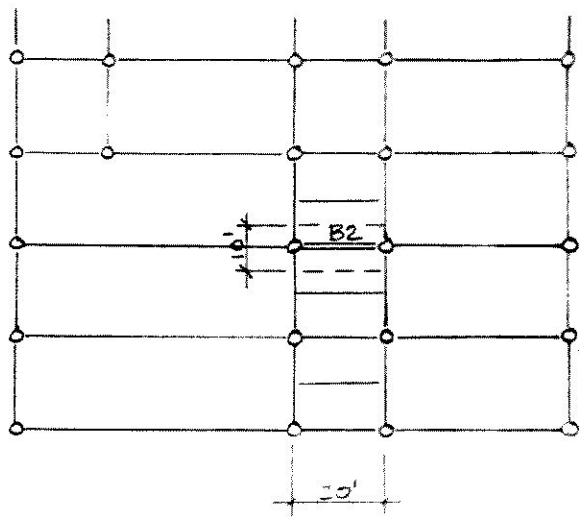

1. Bending

$$w = 60 \text{ psf}(10') = \underline{600 \text{ lbs/ft}}$$

$$W = wL = 600 \text{ lbs/ft}(20') = \underline{12 \text{ K}}$$

$$R_1 = R_2 = 12 \text{ K}/2 = \underline{6 \text{ K}}$$

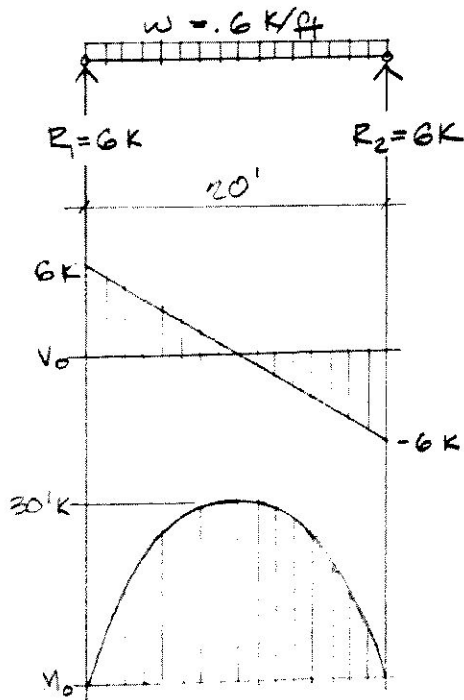

$$M = \frac{wL^2}{8} = \frac{0.6 \text{ K/ft}(20\text{ft})^2}{8} = \underline{30' \text{ K}}$$

using Douglas Fir : $F_b = 2400 \text{ psi}$

assume $C_F = 0.95$

$$S = \frac{M}{C_F F_b} = \frac{30' \text{ K}(12 \text{ in/ft})}{0.95(2.4 \text{ K/in}^2)} = 158 \text{ in}^3$$

B2 cont'd:

select 5 1/8" x 10 - 1 1/2" laminations

$$S = 192.2 \text{ in}^3$$

$$A = 80.7 \text{ in}^2$$

$$d = 15.75 \text{ in}$$

$$I = 1,440 \text{ in}^4$$

2. Shear

$$F_v = 165 \text{ psi (Douglas Fir)}$$

$$f_v = 1.5 \frac{V}{A} = 1.5 \left(\frac{6,000 \text{ lbs}}{80.7 \text{ in}^2} \right) = \underline{112 \text{ psi}} < 165 \text{ psi}^{\text{OK}}$$

3. Deflection

$$\Delta_{\text{allow}} = \frac{L}{360} = \frac{20 \text{ ft} (12 \text{ in/ft})}{360} = \underline{0.67 \text{ in}}$$

$$E = 1.6 \times 10^6 \text{ psi}$$

$$I = 1,440 \text{ in}^4$$

$$w = 600 \text{ lbs/ft}$$

$$\Delta = \frac{5wL^4}{384EI} = \frac{5(600 \text{ lb/ft})(1 \text{ ft}/12 \text{ in}) [(20 \text{ ft})(12 \text{ in/ft})]^4}{384(1.6 \times 10^6 \text{ lb/in}^2)(1.44 \times 10^3 \text{ in}^4)}$$

$$= 0.94 \text{ in} > 0.67 \text{ in} \quad \underline{\text{reject}}$$

$$I_{\text{reqd}} = \frac{5wL^4}{384E\Delta_{\text{allow}}} = \frac{5(600 \text{ lb/ft})(1 \text{ ft}/12 \text{ in}) [(20 \text{ ft})(12 \text{ in/ft})]^4}{384(1.6 \times 10^6 \text{ lb/in}^2)(0.67 \text{ in})}$$

$$= 2,015 \text{ in}^4$$

Use 5 1/8" x 12 - 1 1/2" laminations

$$I = 2,490 \text{ in}^4$$

$$d = 18 \text{ in.}$$

$$A = 12 \text{ in}^2$$

DESIGN B3 :

span = 20'-0"

spacing = 10'-0"

TL = 60 psf

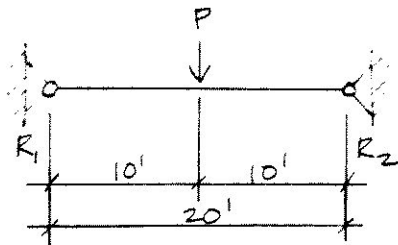
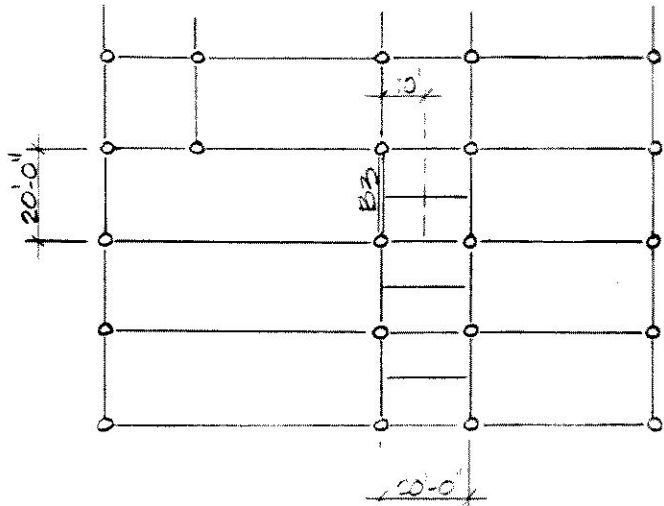

1. Bending

$P = 6 \text{ K}$ (see R, B2)

$R_1 = R_2 = \frac{P}{2} = \frac{6 \text{ K}}{2} = 3 \text{ K}$

$M_{\text{max}} = \frac{PL}{4} = \frac{3 \text{ K}(20 \text{ ft})}{4} = 15 \text{ ' K}$

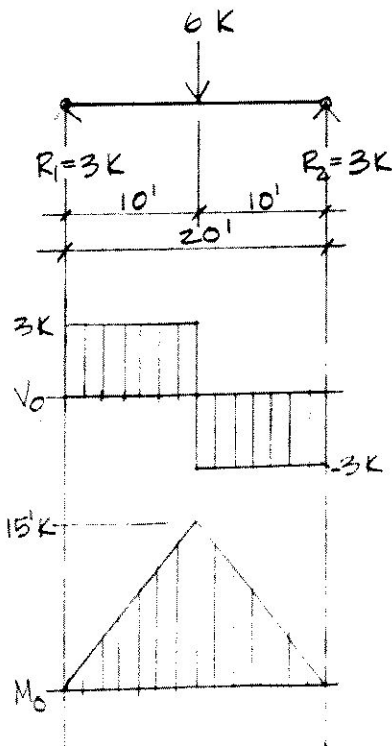

$F_b = 2,400 \text{ psi}$ (Douglas Fir)

assume $C_F = 0.95$

$$S = \frac{M}{C_F F_b} = \frac{15 \text{ ft} \cdot \text{K} (12 \text{ in/ft})}{0.95 (2.4 \text{ K/in}^2)}$$

$$= \underline{79 \text{ in}^3}$$

select $5\frac{1}{8}'' \times 12\text{-}1\frac{1}{2}''$ laminations

$S = 277 \text{ in}^3$

$I = 2,490 \text{ in}^4$

$d = 18''$

$C_F = 0.96$

$A = 92 \text{ in}^2$

* consistent w/ B 2 sizing

B3 cont'd:

2. Shear

$$F_v = 165 \text{ psi}$$

$$f_v = 1.5 \left(\frac{3000 \text{ lbs}}{92 \text{ in}^2} \right) = 33 \text{ psi} \overset{\text{OK}}{<} 165 \text{ psi}$$

3. Deflection

$$\Delta_{\text{allow}} = \frac{L}{360} = \frac{20 \text{ ft} (12 \text{ in/ft})}{360} = \underline{0.67 \text{ in}}$$

$$E = 1.6 \times 10^6 \text{ psi}$$

$$I = 2,490 \text{ in}^4$$

$$\Delta = \frac{PL^3}{48EI} = \frac{6K(1000 \text{ lbs/K}) [(20 \text{ ft})(12 \text{ in/ft})]^3}{48(1.6 \times 10^6 \text{ lbs/in}^2)(2,490 \text{ in}^4)}$$

$$= \underline{0.43 \text{ in}} \overset{\text{OK}}{<} 0.67 \text{ in}$$

DESIGN B4 =

(typical tie beam -
lateral restraint
only)

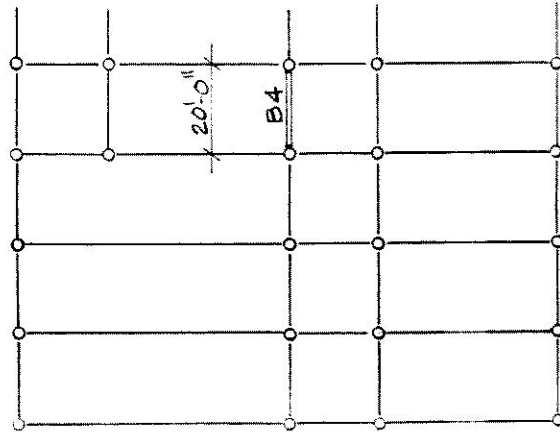

Design as a column - loaded in compression
in horizontal plane

limited by: $l/d < 50$

$$\text{column radius} = 9'' = .75'$$

$$l = 20.0' - 2(.75') = 18.5'$$

select $5\frac{1}{8}'' \times 18''$ glulam beam * (12-1 $\frac{1}{2}''$ lamin's.)
 $b = 5.125''$, substitute for d

$$l/d = \frac{18.5' (12\frac{1}{4}'')}{5.125''} = \underline{43.3}$$

$$43 \overset{\text{OK}}{<} 50$$

* min. depth of 18'' is an aesthetic requirement
(consistent w/ B2, B3 sizing)

DESIGN TYP. COLUMN:

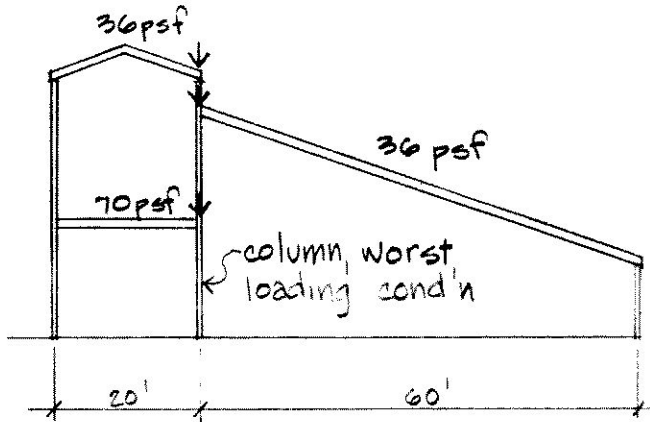

$$f'_c = 4,000 \text{ psi}$$

$$f_y = 49,000 \text{ psi}$$

$$\phi = 0.75 \text{ (spiral reinfmt)}$$

$$\rho_g = 0.03$$

$$\text{load, gable roof: } 36 \text{ psf} (20') (12') = 8.6 \text{ K}$$

$$\text{auditor. roof: } 36 \text{ psf} (20') (30') = 21.6 \text{ K}$$

$$\text{floor: } 70 \text{ psf} (20') (10') = \underline{14 \text{ K}}$$

$$P_n = \underline{45 \text{ K}}$$

$$P_u = \phi P_n = 0.75 (45 \text{ K}) = 34 \text{ K}$$

$$A_g = \frac{34 \text{ K}}{0.64 [0.85 (4 \text{ ksi}) (1 - 0.03) + 40 \text{ ksi} (0.03)]}$$

$$= 11.8 \text{ in}^2$$

using an 18" column (min dia. for aesthetic reasons)

$$A_g = \underline{201 \text{ in}^2}$$

$$201 \text{ in}^2 \overset{\text{OK}}{>} 11.8 \text{ in}^2$$

DETAILS

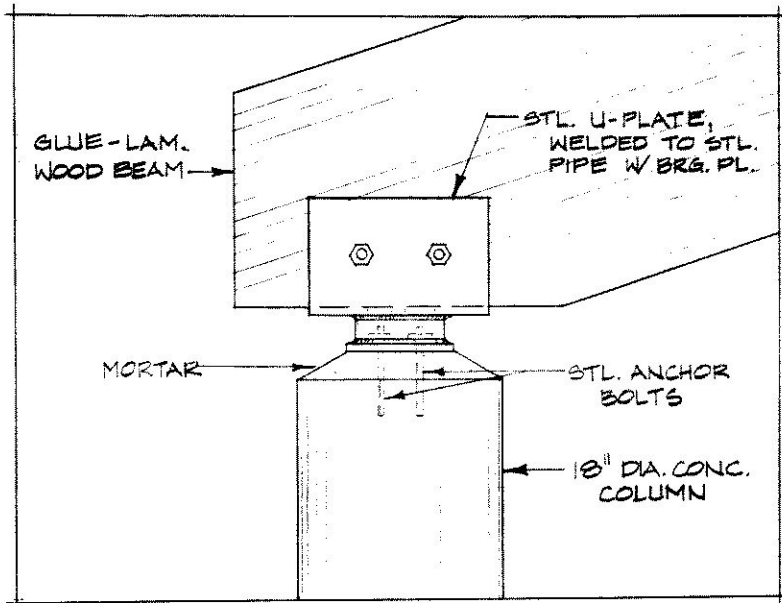

ROOF BEAM TO COLUMN - TOP

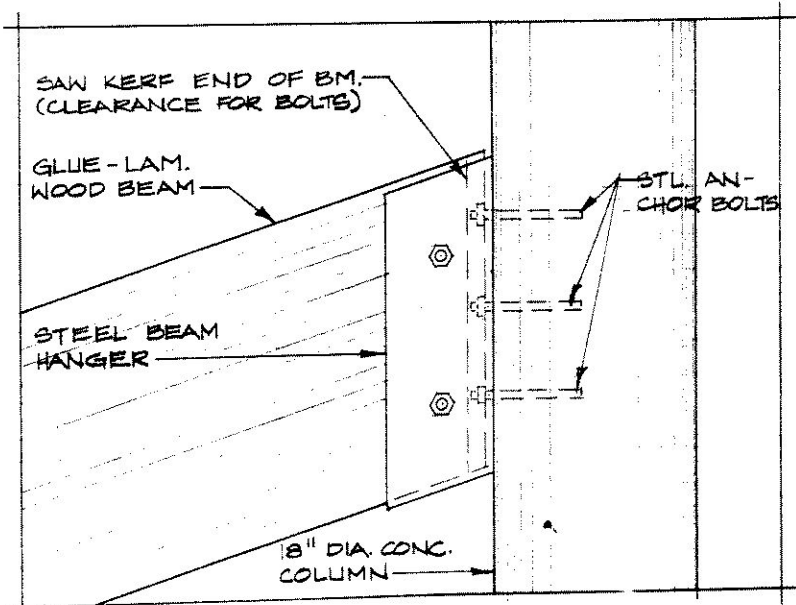

ROOF BEAM TO COLUMN - SIDE

DETAILS CONT'D:

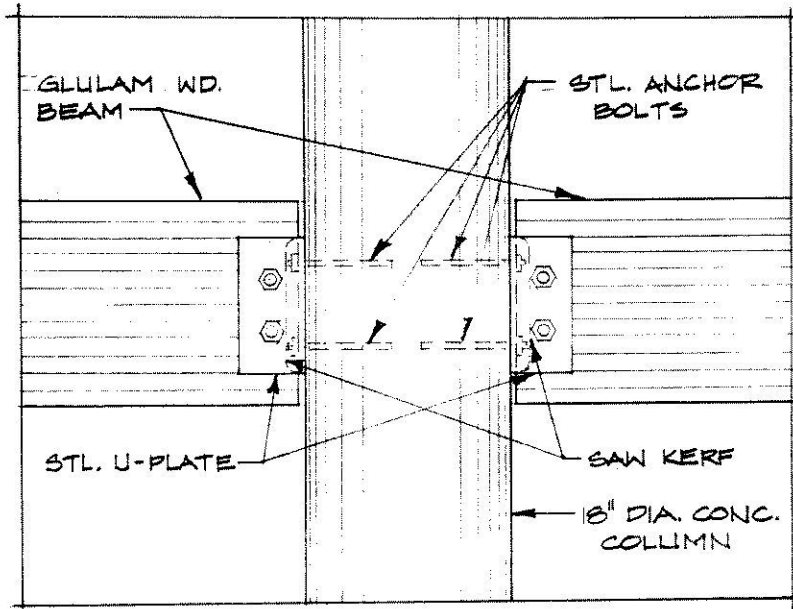

LATERAL TIE BEAMS TO COLUMN

PROFESSIONAL EXAMINATION - M.ARCH Candidates

Spring 1984

Issued March 30 - Due April 12th

1. Write a one page Advertisement for Bids for your project.
2. Prepare a unit-cost type of estimate for your project based upon the most recently issued Mean's Handbook held by the UTA/SAED Library. This should be done by listing the appropriate headings, estimated total quantities, and extended prices. Do not fail to include the costs of the general conditions. Do not include costs of insurance.

This material should be presented on 8½x11 sheets - typewritten.

ADVERTISEMENT FOR BIDS

Separate sealed proposals will be received by the Phoenix Corporation, 1821 Kenwood Terr., Arlington, Texas, for the construction of the Phoenix Bird Rehabilitation Center, until 11:00 o'clock a.m. on the 15th day of August, 1984, at which time and place they will be publicly opened and read aloud.

Any bid received after this time and date will be returned unopened.

Drawings and Specifications are available for inspection in the office of the Architect, Thomas M. Bodell, 512 Columbia Circle, Irving, Texas. Complete sets of Drawings and Specifications may be secured from the Architect upon a deposit of \$50.00 as a guarantee of the safe return of these documents. The full amount of this deposit will be returned to each bidder upon the return of the Drawings and Specifications in good condition. No refund will be obligatory for documents returned later than ten days after the award of the contract.

A Cashier's Check as bid security, in an amount of not less than five percent of the total for the submitted bid, must accompany each bid.

A Performance Bond and a Payment Bond, each for one hundred percent of the contract price, will be required from the successful bidder.

The Phoenix Corporation reserves the right to reject any or all bids and to waive any or all informalities. No bid may be withdrawn until the expiration of 45 days from the date bids are opened.

Date: July 10, 1984

George Stewart

Chairman, Board of Directors,
Phoenix Corporation

UNIT COST ESTIMATE

Project: Phoenix Bird Rehabilitation Center
 Total S.F.: 19,600 s.f.

Item No.	Description	Estim. Quantity	Unit	Unit Price	Estim. Amount
1.1	Spread footings	64	ea.	144.00	9,216
	Strip footings	1,080	l.f.	13.66	14,753
.9	Excavation and backfill	25,000	s.f.	.75	18,750
2.1	Slab on grade, 4" thk.	18,400	s.f.	2.21	40,664
3.1	Columns, 18" round conc.	1,400	v.l.f.	41.85	58,590
	Beams, glue-lam. wood	18,400	s.f.flr.	1.55	28,520
.5	Floor, wood beam & joist	1,200	s.f.	7.09	8,508
.7	Roof, lamin wood deck	21,480	s.f.	4.60	98,808
.9	Stairs, oak tread, wood rails	1	flight	905.00	905
4.1	Ext. wall, 2" x 4" studs, 16" o.c., wood siding, insulation	13,800	s.f.	6.21	85,700
.6	Ext. doors, alum. & glass	5	ea.	3,300.00	16,500
	" " hollow steel	4	ea.	815.00	3,260
.7	Windows, wood frame	206	ea.	285.00	58,710
5.1	Roofing, stdg. seam galv. mtl.	21,480	s.f.	1.09	23,413
.7	Insulation, 1½" rigid	21,480	s.f.	.66	14,177
.8	Gutters, 28 ga. stl., 5" box	840	l.f.	2.87	2,411
6.1	Interior partitions				
	2" x 4" wood stud, 5/8" drywall	1,320	s.f.	2.26	2,983
	2" x 4" wood stud w/acoust. insul.	1,800	s.f.	3.24	5,832
	toilet partitions, plast. lam.	6	ea.	244.00	1,464
	urinal screens, plastic lam.	2	ea.	202.00	404
.4	Interior doors				
	double leaf wood, hollow core	1	ea.	400.00	400
	single leaf wood, hollow core	6	ea.	230.00	1,380
.5	Vinyl plastic wall covering	1,100	s.f.	1.08	1,188
.6	Carpeting, acrylic w/padding	2,000	s.f.	2.29	4,580
	Concrete topping, exposed aggr.	12,800	s.f.	.70	8,960
	Tile, ceramic nat. clay	600	s.f.	3.86	2,316
	" , quarry tile, mud set	12,200	s.f.	4.50	54,900
	Oak strip flooring w.sleepers	3,600		4.05	14,580
8.1	Plumbing-kitchen, toilet & service	18,400	s.f.flr.	.92	16,928
.3	HVAC	18,400	s.f.flr.	10.70	196,880

Item No.	Description	Estim. Quantity	Unit	Unit Price	Estim. Amount
9.1	Electrical - service, lighting	18,400	s.f.flr.	2.50	46,000
11.1	Architectural specialties				
	display cases, free-standing	12	ea.	770.00	9,240
	projector, 35 mm	1	ea.	5,175.00	5,175
	projection screen, wall mounted	150	s.f.	5.20	780
	sound system, dual	1	ea.	4,590.00	4,590
	audit. chair, veneer w/upholstery	200	ea.	110.00	22,000
	acoustic panels, vinyl faced	840	s.f.	7.15	6,006
	range, double oven, comm'l.	1.	ea.	2,483.00	2,483
	dishwasher	1	ea.	425.00	425
	garbage disposer, sink type	1	ea.	355.00	355
	refrigerator, 29 c.f.	1	ea.	1,980.00	1,980
	countertop, plastic lam.	220	s.f.	29.00	6,380
	office furniture	3	set	660.00	1,980
12.3	Utility trenching & bedding	320	l.f.	3.50	1,120
.5	Roadway pavement	480	l.f.	51.00	24,480
	Parking lot pavement	60	car	350.00	<u>21,000</u>
	Sub-Total				949,674
	+ 15% General Conditions (overhead, profit, contingencies, etc.)				+142,451
	+11.5% Architect's fees				<u>+109,213</u>
	Sub-Total				1,201,300
	x 0.96 Location Factor				<u>x 0.96</u>
	TOTAL BUILDING COST				\$1,153,300
	Building cost/s.f.				\$ 58.84

APPENDIX C

STATE OF TEXAS SANITATION REQUIREMENTS

TABLE I
MINIMUM SAFE DISTANCE IN FEET

From	To	Septic Tank	Soil Absorption System	Sewer Pipe With Watertight Joints
Water Wells, Underground Cisterns and Pump Suction Pipes		50*	100**	20
Public Water Supply Lines		5	10	5
Streams, Ponds and Lakes		50*	75	20
Foundation Walls of Structures		5	15	--
Property Lines		10	10	--

* Septic tanks or holding tanks which are designed for submergence (reinforced, monolithic concrete or equal) may be placed within 20 feet of streams, ponds, water wells and underground cisterns, provided the influent and effluent lines to and from the tank are constructed using watertight sewer pipe with compression or solvent welded joints.

** 150 feet is the minimum separation distance for public water wells.

(d) Septic Tank Design - Institutions

- (1) General Consideration of Use of Septic Tank System - Septic tanks may be used as a means of sewage disposal for non-residential activities. However, experience indicates that the usefulness of the septic tank system decreases as the size of the establishment served increases. When a septic tank is being considered for service to an activity that will produce more sewage than a single family residence, design guidance should be obtained from a local health department, regulatory agency or a consultant who is professionally registered as an engineer or sanitarian in Texas.
- (2) Sewage Loading - The total quantity of sewage applied per day to the septic tank provides the basis for the determination of its size. Table IV, entitled, "Individual Usage Rate," will be of assistance in estimating the daily sewage flow per capita for a variety of living and activity situations.
- (3) Compartments to Be Provided - Although single-compartment tanks are acceptable for single family residences, tanks with 2 or more compartments should be provided for large institutional systems. The compartments should be separated by walls with tees or ells to permit liquid flow. The flow line of this intermediate fitting should be at the same elevation of the flow line of the outlet fitting, i.e., 3 inches below the elevation of the flow line of the inlet fitting. The capacity of the first compartment should be at least 1 or 2 times the capacity of the second compartment.
- (4) Selection of Septic Tank Capacity - The net volume or effective capacity below the flow line of a septic tank for flows up to 500 gallons per day should be at least 750 gallons. For flows between 500 and 1,500 gallons per day, the capacity of the tank should be equal to approximately 2 days sewage flow. With flows greater than 1,500 gallons per day, the minimum effective tank capacity should equal 1,125 gallons plus 75 per cent of the daily sewage flow, or

$$V = 1,125 + 0.75 Q$$

Where Q is the average daily flow in gallons per day and V is the tank volume in gallons.

For daily flows over 5,000 gallons per day, consideration should be given to other types of treatment units. More technically advanced processes will probably be more economical than the septic tank for flows in excess of 5,000 gallons per day.

TABLE IV
INDIVIDUAL USAGE RATE

This table may be used for estimating gallons of daily sewage flow per person, to determine minimum tank capacity requirements.

TYPE OF ESTABLISHMENT	GALLONS/PERSON/DAY
Apartment houses	75
Townhouses (with clothes washer)	100
Motels and Hotels.....	60
Restaurants	15
Trailer and RV Parks.....	50
Work or construction camps (semi-permanent).....	50
Youth camps (no meals served).....	15
Schools without cafeterias, gymnasiums or showers.....	15
Schools with cafeterias, but no gymnasiums or showers....	20
Schools with cafeterias, gymnasiums and showers.....	25
Boarding schools.....	100
Office Buildings.....	15
Hospitals	200
Institutions other than hospitals.....	100
Factories (gallons per person per shift, exclusive of industrial wastes).....	20
Parks without bathhouse.....	5
Parks with bathhouse.....	10
Swimming pools and bathhouses.....	10
Country clubs (per resident member)	100
Country clubs (per non-resident member present).....	25
Drive-in theaters (per car space).....	5
Movie theaters (per auditorium seat).....	5
Airports (per passenger).....	5
Self-service laundries (gallons per wash, i.e., per customer).....	50
Stores (total per day per washroom).....	400
Service stations (per vehicle served).....	10

(e) Selection of Proper Subsurface Disposal Method

- (1) In designing a septic tank system, several options concerning subsurface disposal are available. Chart I has been prepared to aid in the selection of the proper system based on lot size, percolation rate and economic considerations. The chart includes the three systems recommended for subsurface disposal which are drainfields, absorption beds and evapotranspiration beds. The purpose of the chart is to give the reader a general idea as to the most feasible type of system to construct taking into consideration lot size, soil absorptive capacity, and volume of soil removed or relocated during construction.
- (2) After sizing an appropriate septic tank, the installer should calculate what bottom area will be required for a trench system, an absorption bed system and an evapotranspiration system. Generally, the system having the least number of square feet of bottom area will be the most economical. In most cases where adequate room is available, a trench system will be the least costly.
- (3) In areas where soils have low permeability, it is possible to design a system which combines both soil absorption and evapotranspiration. Such systems are somewhat complicated and will not be discussed in this text; however, additional information is available at the Texas Department of Health Division of Wastewater Technology and Surveillance.

(f) Effluent Disposal Systems

- (1) Soil Absorption System - General Consideration - The effluent discharged from a septic tank requires further handling to render it safe from a public health standpoint. A well-designed subsurface soil absorption system will allow these liquids to seep into the ground without creating a health hazard or nuisance. After the prospective builder has selected a suitable area and assured himself that safe distances from wells, lakes, etc. can be maintained, he should then determine whether soil formations in the selected area will allow a soil absorption system to work. The single factor of prime importance in the design of a soil absorption system is the percolation rate. The percolation rate determines the amount of drainfield that must be installed to dispose of the septic tank effluent. If the percolation rate falls below the accepted minimum level, another method of sewage disposal must be found. When soil absorption systems are used, there should be no interference from ground water, and the ground water table should be located at least 4 feet below the bottom of the trench. In the coastal areas of Texas, salt water may occur at depths less than 4 feet. If the soil above the salt

CHART I

SUGGESTED FLOW SHEET FOR SELECTING PROPER SUBSURFACE DISPOSAL METHOD

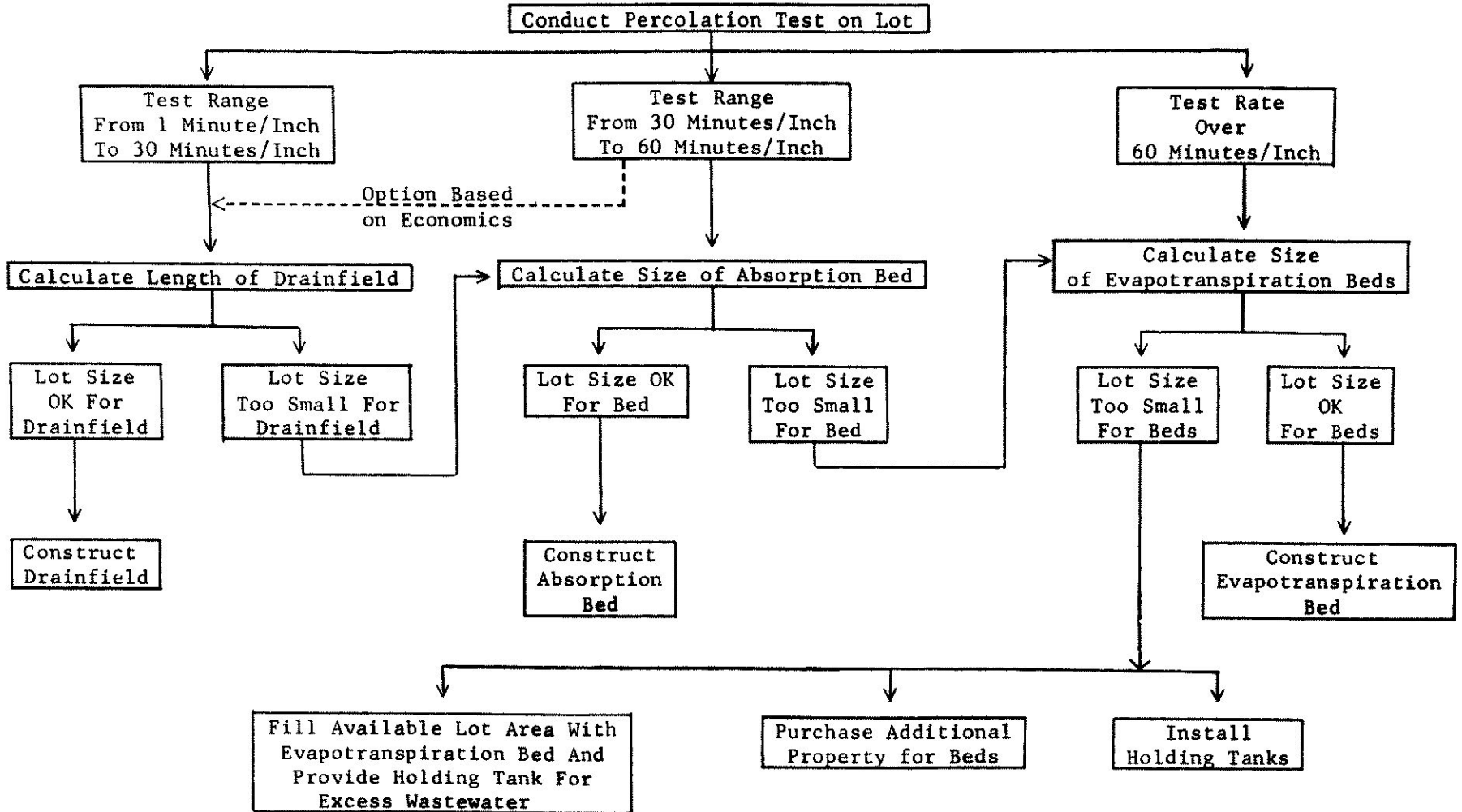

water is shown to have good permeability, an absorption system may be installed and the above separation requirement disregarded. The design standards for soil absorption systems set forth in this publication are based on the premise that impervious strata are at depths greater than 4 feet below the bottom of the absorption trench. Conventional soil absorption systems should not be used if either impervious strata or ground water exist at depths less than 4 feet from the trench or bed bottom.

(2) Absorption Field, Level Terrain

- (A) Absorption Field Sizing - Where the topography or ground slope is not too steep, a flat or level system of gravel-filled trenches or percolation beds is recommended. The use of a looped trench system will avoid dead ends and assure maximum effective utilization of all portions of the system. The capacity of any particular absorption system is fixed by the total area of trench or bed bottom built into the system. The amount of this required minimum area will depend upon the expected sewage load and the average soil percolation rate. The soil percolation rate may be determined by performing a percolation test as described in Rule .002(g) of this pamphlet. The trench dimensions may then be calculated from Table V.
- (B) Absorption Field Construction - All parts of the trench or bed bottom shall be at the same elevation. Trenches should be constructed as shallow as possible with a minimum depth of 18 inches and a maximum depth of 36 inches. For trench depths greater than 24 inches, sand should be used to fill the trench up to the topsoil cover as shown in Figure 4. The trench width should not exceed 30 inches and narrow trenches (12 to 18 inches) are recommended. Although trench length is based on bottom area only, sidewall area is important since much of the wastewater is absorbed through the sidewalls and is evapotranspired. Minimum recommended spacing between adjacent edges of parallel trenches is approximately 5 feet. Liquid from the septic tank is conducted to the absorption system via a watertight line similar to the house sewer. The liquid is distributed uniformly through the gravel-filled trenches by the use of a perforated plastic pipe or equivalent pipe materials. It is important that the distribution piping be laid level in the trenches, with a minimum of 6 inches gravel depth under the pipe and a 2 inch gravel cover. Thus, a total gravel depth of approximately 12 inches would be required. The trench media may be clean graded gravel, broken vitrified brick, washed rock, crushed stone or similar aggregate and may range in size from 1.5 inches to 2.5 inches. Oyster shell, other types of shell and soft limestone are not recommended for trench media because cementitious

TABLE V

ABSORPTION TRENCH SIZING

for

SINGLE FAMILY RESIDENTIAL DWELLINGS

Average Percolation Rate (Minutes/Inch)	Sewage Application Rate, Ra (Gallons Sq. Ft./Day)	Type of Soil (See Chart II)	Minimum Trench Bottom Area (Sq. Ft.) For A One or Two Bedroom House	Minimum Trench Bottom Area For Each Additional Bedroom (Sq. Ft./Bedroom) *
<1	Too Great For Consideration	Gravel	See Evapotranspiration Process Paragraph B-4.1.4.	
1-5	2.0	Sand	250	125
6-15	1.3	Sandy Loam	380	200
16-30	1.0	Sandy Clay	500	250
31-45	0.8	Silty Clay	625	300
46-60	0.6	Clay Loam	800	400
>60	<0.1	Clay	Absorptive Systems Are Not Recommended	

* Minimum trench bottom area is calculated to include capacity for washing machine wastewater, organic material from garbage grinders, and infiltration from average rainfall.

Recommended spacing between parallel trenches is 5 feet. Under no circumstances shall this distance be reduced to less than 4 feet.

When dwellings consist of a large living area relative to the number of designated bedrooms, the following guidelines should be used to approximate the trench area:

Less than 1,500 sq. ft. - Use trench area for two bedroom house
 1,500 sq. ft. to 1,900 sq. ft. - Use trench area for three bedroom house
 For each additional 400 sq. ft. - Add trench area equal to one bedroom

properties of this type of material often result in early trench failure. The distribution pipe should consist of plastic perforated pipe or equivalent materials with an SDR ratio (ratio of pipe thickness to diameter) no greater than 41. Normally, 4 inch diameter pipe is used for drainfield construction, however, the diameter may range from 3 inches to 6 inches and yield satisfactory results. Jointed tile is not recommended for use because of the difficulty in maintaining joint spacing and keeping the line level. Covering of straw, butcher paper or similar decomposable material over the top of the gravel is also recommended to prevent the soil or sand backfill from invading the gravel until the backfill becomes stabilized. Tar paper or other impervious material should not be used under any circumstance. The pipe selected for drainfield construction should have sufficient strength to resist crushing from external loadings such as automobiles, yard tractors and earth moving equipment. In no case shall bituminous fiberboard or paper pipe (Orangeburg or similar designations) be used anywhere in the septic tank system. Poor construction practices will cause serious damage to the soil absorption system. It is extremely important that care be taken to avoid sealing the surface of the bottom and sides of the absorption trenches through smearing. Trenches or beds should not be excavated when the soil is sufficiently wet so as to smear or compact easily. All smeared or compacted surfaces occurring during construction should be raked to a depth of 1 inch and loose material removed just before the gravel or other media is placed.

(3) Absorption Field, Irregular Terrain

- (A) Absorption Trenches - Where the topography or ground slope is too steep for feasible construction of a closed-loop trench system, the following alternate layout may be used. A single, level trench, constructed like the closed-loop trench, is built along a contour and the overflow from this line is conducted via a watertight line through undisturbed soil to the next lower level, where a second trench can be built along a contour similar to the upper trench. The pattern can be repeated until the required minimum trench bottom area has been provided. It is recommended that no individual trench exceed 100 feet in length. This technique is graphically illustrated in Figure 5. Other details of trench construction described in Rule .002(f)(1) and shown in Figure 4 should be followed.

- (B) Soil Absorption Beds - In addition to the trench-type absorption field, an absorption bed, as detailed in Figure 6, may be used in areas where the combination of soil percolation and lot size precludes the use of a trench-type system with minimum spacing between trenches. While absorption beds require more bottom area than trenches, they tend to be more compact since 5 feet of spacing is required between trenches. The bed shall be constructed with a depth ranging from 18 inches to 36 inches. The bed should be kept as shallow as possible (18 minimum depth) to promote aerobic bacterial action in the soil and the bottom of the bed should be level for uniform wastewater distribution. Six inches of 1.5 inch to 2.5 inch media (gravel, crushed stone, etc.) shall be placed on the bed bottom followed by two or more distribution pipes spaced 3 to 4 feet apart and 3 feet from the edge of the bed. The distributor pipe is then covered with additional gravel to a depth of approximately 2 inches. Since the pipe is approximately 4 inches in diameter, the total depth of gravel in the bed will be 12 inches. The gravel should then be covered with a decomposable material, such as butcher paper, to prevent the final soil layer from invading the gravel and reducing porosity. The next soil layer should consist of sand, sandy loam or a mixture of the two. If clay, rock or other semi-impervious material is excavated, from the bed it should be removed and under no circumstances be used to backfill the bed. Sand or sandy loam will provide a capillary medium to help eliminate some of the wastewater through evapotranspiration Rule .002(f)(4). The bed should be filled to within 3 inches from the top with sand or sandy loam and mounded with sandy loam so that the center of the bed is approximately 4 inches above normal ground elevation. This will provide drainage away from the absorption bed.
- (C) Absorption Bed Sizing - When this system is used, the absorption bed area may be calculated using the following formula:

For Dwellings:

$$A = \frac{300 (1 + B)}{R_a}$$

Where

A = The total absorption bed area

B = The total number of bedrooms in the dwelling

R_a = Sewage application rate for absorption trenches
(gal/sq. ft./day) based on percolation rate.
(See Table V)

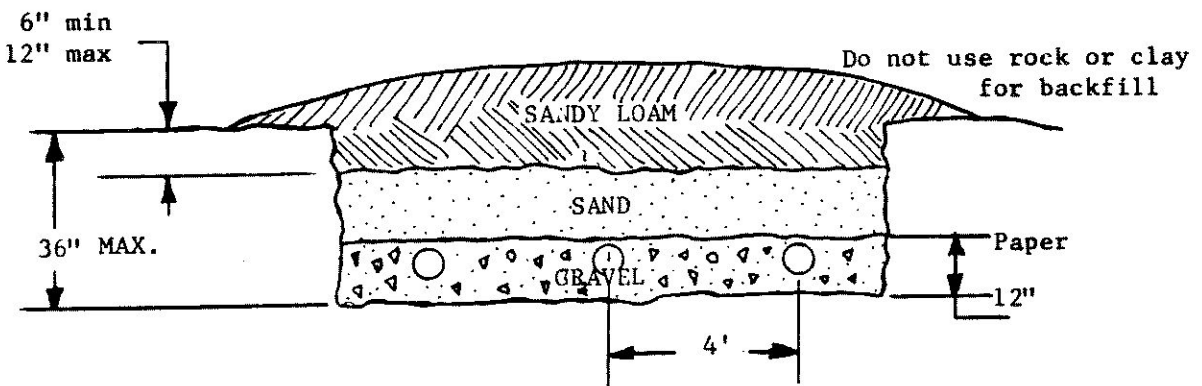
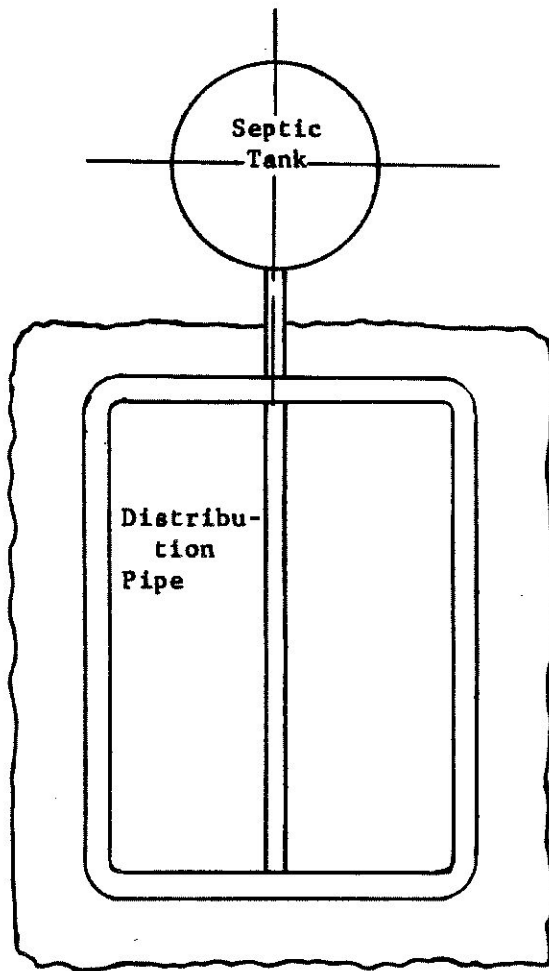

FIG. 6 ABSORPTION BED SYSTEM

For Non-Residential Institutions:

$$A = \frac{3Q}{R_a}$$

Where

Q = Daily wastewater discharge from institution (gal/day).

(4) Evapotranspiration Beds

- (A) Use of Evapotranspiration Beds - Evapotranspiration bed systems may be used in locations where soil conditions are not suitable for any type of soil absorption system. The construction of an evapotranspiration bed is similar to an absorptive system except two beds are required with a control valve to divert wastewater from one bed to the other.
- (B) Evapotranspiration Bed Construction Features - Beds are constructed in impervious soil or soil with very high absorptive capacity. When the soil has a very high absorptive capacity (<1minute/inch) liners must be constructed to guard against the possibility of wastewater discharging through the soil (fissured rock or gravel) and contaminating streams, lakes or shallow ground water. Impervious liners may consist of concrete, hot mopped asphaltic membrane, plastic reservoir liners or other approved pit lining materials. Liners are not required in impervious soils and should not be used since some of the wastewater may be absorbed in the soil and reduce the overall evapotranspiration load. An evapotranspiration system should be designed using the following parameters:
- (i) Beds may be designed in any configuration (square, round, etc.) but the total number of square feet of bed area must be determined by the formula in Rule .002(f)(4)(C).
 - (ii) At least two beds must be constructed with valves arranged to allow the effluent from a septic tank to alternate between each bed. When one bed becomes saturated (top of bed remains moist) the valve is opened to allow effluent to flow into the alternate bed.
 - (iii) The beds should be constructed as shallow as possible with a depth ranging from 18 inches to a maximum of 24 inches. This is necessary to keep the beds aerobic and prevent clogging.
 - (iv) Rock media is placed on the bed bottom to a depth of 12 inches or less depending on the overall bed depth. (If a liner is used which is subject to puncture, sand should be placed on both sides of the liner.)

immediately prior to sorting or wrapping the utensils. Unless single-service knives, forks and spoons are prewrapped or prepackaged, holders shall be provided to protect these items from contamination, and present the handle of the utensil to the consumer.

(4) Prohibited Storage Area. The storage of food equipment, utensils or single-service articles in toilet rooms or vestibules is prohibited.

.007. Sanitary Facilities and Controls.

(a) Water Supply.

(1) General. Enough potable water for the needs of the food service establishment shall be provided from a source constructed and operated according to law.

(2) Transportation. All potable water not provided directly by pipe to the food service establishment from the source shall be transported in a bulk water transport system and shall be delivered to a closed-water system. Both of these systems shall be constructed and operated according to law.

(3) Bottled Water. Bottled and packaged potable water shall be obtained from a source that complies with all laws and shall be handled and stored in a way that protects it from contamination. Bottled and packaged potable water shall be dispensed from the original container.

(4) Water Under Pressure. Water under pressure at the required temperatures shall be provided to all fixtures and equipment that use water.

(5) Steam. Steam used in contact with food or food-contact surfaces shall be free from any harmful materials or additives.

(b) Sewage. All sewage, including liquid waste, shall be disposed of by a public sewerage system or by a sewage disposal system constructed and operated

according to law. Nonwater carried sewage disposal facilities are prohibited, except as permitted by Rule .010 (pertaining to temporary food service establishments) or as permitted by the regulatory authority in remote areas or because of special situations.

(c) Plumbing.

(1) General. Plumbing shall be sized, installed, and maintained according to law. There shall be no cross-connection between the potable water supply and any nonpotable or questionable water supply nor any source of pollution through which the potable water supply might become contaminated.

(2) Nonpotable Water System. A nonpotable water system is permitted only for purposes such as air-conditioning and fire protection and only if the system is installed according to law and the nonpotable water does not contact, directly or indirectly, food, potable water, equipment that contacts food, or utensils. The piping of any nonpotable water system shall be durably identified so that it is readily distinguishable from piping that carries potable water.

(3) Backflow. The potable water system shall be installed to preclude the possibility of backflow. Devices shall be installed to protect against backflow and backsiphonage at all fixtures and equipment where an air gap at least twice the diameter of the water supply inlet is not provided between the water supply inlet and the fixture's flood level rim. A hose shall not be attached to a faucet unless a backflow prevention device is installed.

(4) Grease Traps. If used, grease traps shall be located to be easily accessible for cleaning.

(5) Garbage Grinders. If used, garbage grinders shall be installed and maintained according to law.

(6) Drains. Except for properly trapped open sinks, there shall be no direct connection between the sewerage system and any drains originating from equipment in which food, portable equipment, or utensils are placed. When a dishwashing machine is located within five feet of a trapped floor drain, the dishwasher waste outlet may be connected directly on the inlet side of a properly vented floor drain trap if permitted by law.

(d) Toilet Facilities.

(1) Toilet Installation. Toilet facilities shall be installed according to law, shall be the number required by law, shall be conveniently located, and shall be accessible to employees at all times.

(2) Toilet Design. Toilets and urinals shall be designed to be easily cleanable.

(3) Toilet Rooms. Toilet rooms shall be completely enclosed and shall have tight-fitting, self-closing, solid doors, which shall be closed except during cleaning or maintenance.

(4) Toilet Fixtures. Toilet fixtures shall be kept clean and in good repair. A supply of toilet tissue shall be provided at each toilet at all times. Easily cleanable receptacles shall be provided for waste materials. Toilet rooms used by women shall have at least one covered waste receptacle.

(e) Lavatory Facilities.

(1) Lavatory Installation. Lavatories shall be at least the number required by law, shall be installed according to law, and shall be located to permit convenient use by all employees in food preparation areas and utensil-washing areas. Lavatories shall be accessible to employees at all times. Lavatories shall also be located in or immediately adjacent to toilet rooms or

vestibules. Sinks used for food preparation or for washing equipment or utensils shall not be used for handwashing.

(2) Lavatory Faucets. Each lavatory shall be provided with hot and cold water tempered by means of a mixing valve or combination faucet. Any self-closing, slow-closing, or metering faucet used shall be designed to provide a flow of water for at least fifteen seconds without the need to reactivate the faucet. Steam-mixing valves are prohibited.

(3) Lavatory Supplies. A supply of hand-cleansing soap or detergent shall be available at each lavatory. A supply of sanitary towels or a hand-drying device providing heated air shall be conveniently located near each lavatory. Common towels are prohibited. If disposable towels are used, easily cleanable waste receptacles shall be conveniently located near the handwashing facilities.

(4) Lavatory Maintenance. Lavatories, soap dispensers, hand-drying devices and all related fixtures shall be kept clean and in good repair.

(f) Garbage and Refuse.

(1) Containers.

(A) Garbage and refuse shall be kept in durable, easily cleanable, insect-proof and rodent-proof containers that do not leak and do not absorb liquids. Plastic bags and wet-strength paper bags may be used to line these containers, and they may be used for storage inside the food service establishment.

(B) Containers used in food preparation and utensil-washing areas shall be kept covered after they are filled.

(C) Containers stored outside the establishment, and dumpsters, compactors and compactor systems shall be easily cleanable, shall be provided with tight-fitting lids, doors or covers, and shall be kept covered when not in

actual use. In containers designed with drains, drain plugs shall be in place at all times, except during cleaning.

(D) There shall be a sufficient number of containers to hold all the garbage and refuse that accumulates.

(E) Soiled containers shall be cleaned at a frequency to prevent insect and rodent attraction. Each container shall be thoroughly cleaned on the inside and outside in a way that does not contaminate food, equipment, utensils, or food preparation areas. Suitable facilities, including hot water and detergent or steam, shall be provided and used for washing containers. Liquid waste from compacting or cleaning operations shall be disposed of as sewage.

(2) Storage.

(A) Garbage and refuse on the premises shall be stored in a manner to make it inaccessible to insects and rodents. Outside storage of unprotected plastic bags or wet-strength paper bags or baled units containing garbage or refuse is prohibited. Cardboard or other packaging material not containing garbage or food wastes need not be stored in covered containers.

(B) Garbage or refuse storage rooms, if used, shall be constructed of easily cleanable, nonabsorbent, washable materials, shall be kept clean, shall be insect-proof and rodent-proof and shall be large enough to store the garbage and refuse containers that accumulate.

(C) Outside storage areas or enclosures shall be large enough to store the garbage and refuse containers that accumulate and shall be kept clean. Garbage and refuse containers, dumpsters and compactor systems located outside shall be stored on or above a smooth surface of nonabsorbent material, such as concrete or machine-laid asphalt, that is kept clean and maintained in good repair.

(3) Disposal.

(A) Garbage and refuse shall be disposed of often enough to prevent the development of odor and the attraction of insects and rodents.

(B) Where garbage or refuse is burned on the premises, it shall be done by controlled incineration that prevents the escape of particulate matter in accordance with law. Areas around incineration facilities shall be kept clean and orderly.

(g) Insect and Rodent Control.

(1) General. Effective measures intended to minimize the presence of rodents, flies, cockroaches, and other insects on the premises shall be utilized. The premises shall be kept in such condition as to prevent the harborage or feeding of insects or rodents.

(2) Openings. Openings to the outside shall be effectively protected against the entrance of rodents. Outside openings shall be protected against the entrance of insects by tight-fitting, self-closing doors, closed windows, screening, controlled air currents, or other means. Screen doors shall be self-closing, and screens for windows, doors, skylights, transoms, intake and exhaust air ducts, and other openings to the outside shall be tight-fitting and free of breaks. Screening material shall not be less than sixteen(16) mesh to the inch.

.008. Construction and Maintenance of Physical Facilities.

(a) Floors.

(1) Floor Construction. Floors and floor coverings of all food preparation, food storage, and utensil-washing areas, and the floors of all walk-in refrigerating units, dressing rooms, locker rooms, toilet rooms and vestibules shall be constructed of smooth durable material such as sealed concrete, terrazzo,

ceramic tile, durable grades of linoleum or plastic, or tight wood impregnated with plastic, and shall be maintained in good repair. Nothing in this rule shall prohibit the use of antislip floor covering in areas where necessary for safety reasons.

(2) Floor Carpeting. Carpeting, if used as a floor covering, shall be of closely woven construction, properly installed, easily cleanable, and maintained in good repair. Carpeting is prohibited in food preparation, equipment-washing and utensil-washing areas where it would be exposed to large amounts of grease and water, in food storage areas, and toilet room areas where urinals or toilet fixtures are located.

(3) Prohibited Floor Covering. The use of sawdust, wood shavings, peanut hulls, or similar material as a floor covering is prohibited.

(4) Floor Drains. Properly installed, trapped floor drains shall be provided in floors that are water flushed for cleaning or that receive discharges of water or other fluid waste from equipment, or in areas where pressure spray methods for cleaning equipment are used. Such floors shall be constructed only of sealed concrete, terrazzo, ceramic tile or similar materials, and shall be graded to drain.

(5) Mats and Duckboards. Mats and duckboards shall be of nonabsorbent, grease resistant materials and of such size, design, and construction as to facilitate their being easily cleaned. Duckboards shall not be used as storage racks.

(6) Floor Junctures. In all new or extensively remodeled establishments utilizing concrete, terrazzo, ceramic tile or similar flooring materials, and where water flush cleaning methods are used, the junctures between walls and floors shall

be coved and sealed. In all other cases, the juncture between walls and floors shall not present an open seam of more than 1/32 inch.

(7) Utility Line Installation. Exposed utility service lines and pipes shall be installed in a way that does not obstruct or prevent cleaning of the floor. In all new or extensively remodeled establishments, installation of exposed horizontal utility lines and pipes on the floor is prohibited.

(b) Walls and Ceilings.

(1) Maintenance. Walls and ceilings, including doors, windows, skylights, and similar closures, shall be maintained in good repair.

(2) Construction. The walls, including nonsupporting partitions, wall coverings, and ceilings of walk-in refrigerating units, food preparation areas, food storage areas, equipment-washing and utensil-washing areas, toilet rooms and vestibules shall be light-colored, smooth, nonabsorbent, and easily cleanable. Concrete or pumice blocks used for interior wall construction in these locations shall be finished and sealed to provide an easily cleanable surface.

(3) Exposed Construction. Studs, joists, and rafters shall not be exposed in those areas listed in paragraph (2) of subsection (b) of this rule. If exposed in other rooms or areas, they shall be finished to provide an easily cleanable surface.

(4) Utility Line Installation. Exposed utility service lines and pipes shall be installed in a way that does not obstruct or prevent cleaning of the walls and ceilings. Utility service lines and pipes shall not be unnecessarily exposed on walls or ceilings in those areas listed in paragraph (2) of subsection (b) of this rule.

(5) Attachments. Light fixtures, vent covers, wall-mounted fans,

decorative materials, and similar equipment attached to walls and ceilings shall be easily cleanable and shall be maintained in good repair.

(6) Covering Material Installation. Wall and ceiling covering materials shall be attached and sealed so as to be easily cleanable.

(c) Cleaning Physical Facilities.

(1) General. Cleaning of floors and walls, except emergency cleaning of floors, shall be done during periods when the least amount of food is exposed, such as after closing or between meals. Floor, mats, duckboards, walls, ceilings, and attached equipment and decorative materials shall be kept clean. Only dustless methods of cleaning floors and walls shall be used, such as vacuum cleaning, wet cleaning, or the use of dust-arresting sweeping compounds with brooms.

(2) Utility Facility. In new or extensively remodeled establishments at least one utility sink or curbed cleaning facility with a floor drain shall be provided and used for the cleaning of mops or similar wet floor cleaning tools and for the disposal of mop water or similar liquid wastes. The use of lavatories, utensil-washing or equipment-washing, or food preparation sinks for this purpose is prohibited.

(d) Lighting.

(1) General. At least fifty(50) foot candles of light shall be provided to all working surfaces and at least thirty(30) foot candles of light shall be provided to all other surfaces and equipment in food preparation, utensil-washing, and handwashing areas, and in toilet rooms. At least twenty(20) foot candles of light at a distance of thirty(30) inches from the floor shall be provided in all other areas, except that this requirement applies to dining areas only during cleaning operations.

(2) Protective Shielding.

(A) Shielding to protect against broken glass falling onto food shall be provided for all artificial lighting fixtures located over, by, or within food storage, preparation, service, and display facilities, and facilities where utensils and equipment are cleaned and stored.

(B) Infra-red or other heat lamps shall be protected against breakage by a shield surrounding and extending beyond the bulb, leaving only the face of the bulb exposed.

(e) Ventilation.

(1) General. All rooms shall have sufficient ventilation to keep them free of excessive heat, steam, condensation, vapors, obnoxious odors, smoke and fumes. Ventilation systems shall be installed and operated according to law and, when vented to the outside, shall not create an unsightly, harmful or unlawful discharge.

(2) Special Ventilation.

(A) Intake and exhaust air ducts shall be maintained to prevent the entrance of dust, dirt, and other contaminating materials.

(B) In new or extensively remodeled establishments, all rooms from which obnoxious odors, vapors or fumes originate shall be mechanically vented to the outside.

(f) Dressing Rooms and Locker Areas.

(1) Dressing Rooms and Areas. If employees routinely change clothes within the establishment, rooms or areas shall be designated and used for that purpose. These designated rooms or areas shall not be used for food preparation, storage or service, or for utensil-washing or storage.

(2) Locker Area. Enough lockers or other suitable facilities shall be provided and used for the orderly storage of employee clothing and other belongings. Lockers or other suitable facilities may be located only in the designated dressing rooms or in food storage rooms or areas containing only completely packaged food or packaged single-service articles.

(g) Poisonous or Toxic Materials.

(1) Materials Permitted. Only those poisonous or toxic materials necessary for the maintenance of the establishment, the cleaning and sanitization of equipment and utensils, and the control of insects and rodents shall be present in food service establishments.

(2) Labeling of Materials. Containers of poisonous or toxic materials shall be prominently and distinctly labeled according to law for easy identification of contents.

(3) Storage of Materials. Poisonous or toxic materials consist of the following three(3) categories:

- (A) Insecticides and rodenticides;
- (B) Detergents, sanitizers, and related cleaning or drying agents;
- (C) Caustics, acids, polishes, and other chemicals.

Each of these categories shall be stored and located to be physically separated from each other. All poisonous or toxic materials shall be stored in cabinets or in similar physically separated compartments or facilities used for no other purpose. To preclude potential contamination, poisonous or toxic materials shall not be stored above food, food equipment, utensils or single-service articles, except that this requirement does not prohibit the convenient availability of detergent or sanitizers at utensil or dishwashing stations.

(4) Use of Materials.

(A) Bactericides, cleaning compounds or other compounds intended for use on food-contact surfaces shall not be used in a way that leaves a toxic residue on such surfaces, nor in a way that constitutes a hazard to employees or other persons.

(B) Poisonous or toxic materials shall not be used in a way that contaminates food, equipment, or utensils, nor in a way that constitutes a hazard to employees or other persons, nor in a way other than in full compliance with the manufacturer's labeling.

(5) Personal Medications. Personal medications shall not be stored in food storage, preparation or service areas.

(6) First Aid Supplies. First aid supplies shall be stored in a way that prevents them from contaminating food and food-contact surfaces.

(h) Premises.

(1) General.

(A) Food service establishments and all parts of the property used in connection with operations of the establishments shall be kept free of litter.

(B) The walking and driving surfaces of all exterior areas of food service establishments shall be surfaced with concrete or asphalt, or with gravel or similar material effectively treated to facilitate maintenance and minimize dust. These surfaces shall be graded to prevent pooling and kept free of litter.

(C) Only articles necessary for the operation and maintenance of the food service establishment shall be stored on the premises.

(D) The traffic of unnecessary persons through the food preparation and utensil-washing areas is prohibited.

(2) Living Areas. No operation of a food service establishment shall be conducted in any room used as living or sleeping quarters. Food service operations shall be separated from any living or sleeping quarters by complete partitioning and solid, self-closing doors.

(3) Laundry Facilities.

(A) Laundry facilities in a food service establishment shall be restricted to the washing and drying of linens, cloths, uniforms and aprons necessary to the operation. If such items are laundered on the premises, an electric, gas, or steam dryer shall be provided and used.

(B) Separate rooms shall be provided for laundry facilities except that such operations may be conducted in storage rooms containing only packaged foods or packaged single-service articles.

(4) Linens and Clothes Storage.

(A) Clean clothes and linens shall be stored in a clean place and protected from contamination until used.

(B) Soiled clothes and linens shall be stored in nonabsorbent containers or washable laundry bags until removed for laundering.

(5) Cleaning Equipment Storage. Maintenance and cleaning tools such as brooms, mops, vacuum cleaners and similar equipment shall be maintained and stored in a way that does not contaminate food, utensils, equipment, or linens and shall be stored in an orderly manner to facilitate the cleaning of that storage location.

(6) Animals. Live animals, including birds, and turtles, shall be

excluded from within the food service operational premises and from immediately adjacent areas under the control of the food service establishment. This exclusion does not apply to edible fish, crustacea, shellfish, or to fish in aquariums. Patrol dogs accompanying security or police officers, or guide dogs accompanying blind persons shall be permitted in dining areas.

.009. Mobile Food Units.

(a) Mobile Food Service.

(1) General. Mobile food units shall comply with the requirements of these rules, except as otherwise provided in this paragraph and in paragraph (2) of subsection (a) of this rule. The regulatory authority may impose additional requirements to protect against health hazards related to the conduct of the food service establishment as a mobile operation, may prohibit the sale of some or all potentially hazardous food, and when no health hazard will result, may waive or modify requirements of this rule relating to physical facilities, except those requirements in this rule of paragraphs (4) and (5) of subsection (a); paragraph (1) of subsection (b); and paragraphs (1) and (2) of subsection (c).

(2) Restricted Operation. Mobile food units that serve only food that is prepared, packaged in individual servings, transported and stored under conditions meeting the requirements of these rules, or beverages that are not potentially hazardous and are dispensed from covered urns or other protected equipment, need not comply with requirements of these rules pertaining to the necessity of water and sewage systems nor to those requirements pertaining to the cleaning and sanitization of equipment and utensils if the required equipment for cleaning and sanitization exists at its commissary.

(3) Single-Service Articles. Mobile food units shall provide only